

***cincoze***

# CO-100/P2202 Series

## User Manual



### **Open Frame Panel PC**

TFT-LCD Open Frame Panel PC with Intel® 12th Gen. Alder Lake-P U Series Core™ Processor

# Contents

Preface.....	5
Revision .....	5
Copyright Notice .....	5
Acknowledgement .....	5
Disclaimer.....	5
Declaration of Conformity.....	6
Product Warranty Statement .....	6
Technical Support and Assistance .....	8
Conventions Used in this Manual .....	8
Safety Precautions.....	9
Package Contents .....	10
Ordering Information .....	10
Chapter 1 Product Introductions .....	12
1.1 Overview .....	13
1.2 Specifications .....	15
1.2.1 CO-119C-R10/P2202 Series .....	15
1.2.2 CO-W121C-R10/P2202 Series .....	20
1.3 External Layout.....	25
1.3.1 Front .....	25
1.3.2 Rear.....	26
1.3.3 Left.....	27
1.3.4 Right.....	28
Chapter 2 Introduction to Switches and Connectors .....	29
2.1 Location of Switches and Connectors .....	30
2.1.1 Top View .....	30
2.1.2 Bottom View .....	30
2.2 Switches and Connectors Definition .....	31
2.3 Definition of Switches .....	32
2.4 Definition of Connectors .....	34
2.5 Optional Module Pin Definition & Settings.....	40
2.5.1 CFM-IGN101 Module.....	40
Chapter 3 System Setup .....	41
3.1 Removing the Top Cover .....	42
3.2 Installing Mini PCIe Card(s) .....	43
3.3 Installing a M.2 E Key Card .....	44
3.4 Installing Antenna(s) .....	45
3.5 Installing SO-DIMM(s) .....	46
3.6 Installing a PCI(e) Card .....	47

3.7	Installing Thermal Pad of Thermal Block.....	49
3.8	Installing the Top Cover.....	50
3.9	Disassemble the CO Display Module .....	51
3.10	Installing a SATA Hard Drive at Front Panel.....	52
3.11	Installing a SATA hard drive on Bottom Side .....	54
3.12	Installing a SIM Card.....	56
3.13	Installing CFM Modules.....	57
3.13.1	CFM-IGN101 Module.....	57
3.13.2	CFM-PoE04 Module.....	58
3.14	Installing MEC Modules.....	60
3.14.1	MEC-COM-M212-TDB9/UB1203 Module.....	60
3.14.2	MEC-COM-M334-TDB9/UB1203 Module.....	63
3.14.3	MEC-USB-M102-30/UB1214 Module.....	66
3.14.4	MEC-LAN-M102-30/UB1211 Module.....	69
3.15	Installing Standard Mount.....	72
3.15.1	Fixing from front side .....	73
3.15.2	Fixing from rear side.....	74
3.16	Installing Flat Mount .....	76
3.16.1	Fixing from front side .....	81
3.16.2	Fixing from rear side.....	82
3.17	Disassemble the mounting brackets .....	83
3.18	Installing VESA Mount .....	85
3.19	Installing Rack Mount.....	87
Chapter 4	BIOS Setup.....	89
4.1	BIOS Introduction.....	90
4.2	Main Setup.....	91
4.3	Advanced Setup .....	92
4.3.1	CPU Configuration .....	92
4.3.2	SATA Configuration .....	93
4.3.3	PCH-FW Configuration.....	93
4.3.4	Trusted Computing.....	94
4.3.5	ACPI Settings.....	95
4.3.6	F81966 Super IO Configuration .....	96
4.3.7	Hardware Monitor.....	97
4.3.8	S5 RTC Wake Settings.....	98
4.3.9	Serial Port Console Redirection.....	98
4.3.10	USB Configuration .....	99
4.3.11	Network Stack Configuration .....	99
4.3.12	CSM Configuration .....	100
4.4	Chipset Setup .....	100

4.4.1 System Agent (SA) Configuration .....	101
4.4.2 PCH-IO Configuration .....	104
4.5 Security Setup .....	106
4.6 Boot Setup.....	107
4.7 Save & Exit.....	108
4.8 MEBx .....	109
Chapter 5 Product Application .....	112
5.1 Where to download drivers? .....	113
5.2 Where to find the technical documents? .....	113



## Declaration of Conformity



### FCC

This equipment has been tested and found to comply with the limits for a Class A digital device, pursuant to Part 15 of the FCC Rules. These limits are designed to provide reasonable protection against harmful interference when the equipment is operated in a commercial environment. This equipment generates, uses, and can radiate radio frequency energy and, if not installed and used in accordance with the instruction manual, may cause harmful interference to radio communications. Operation of this equipment in a residential area is likely to cause harmful interference in which case the user will be required to correct the interference at his own expense.



### CE

The product(s) described in this manual complies with all application European Union (CE) directives if it has a CE marking. For computer systems to remain CE compliant, only CE-compliant parts may be used. Maintaining CE compliance also requires proper cable and cabling techniques.

## Product Warranty Statement

### Warranty

Cincoze products are warranted by Cincoze Co., Ltd. to be free from defect in materials and workmanship for 2 years (2 Years for PC Module, 1 Year for Display Module) from the date of purchase by the original purchaser. During the warranty period, we shall, at our option, either repair or replace any product that proves to be defective under normal operation. Defects, malfunctions, or failures of the warranted product caused by damage resulting from natural disasters (such as by lightening, flood, earthquake, etc.), environmental and atmospheric disturbances, other external forces such as power line disturbances, plugging the board in under power, or incorrect cabling, and damage caused by misuse, abuse, and unauthorized alteration or repair, and the product in question is either software, or an expendable item (such as a fuse, battery, etc.), are not warranted.

### RMA

Before sending your product in, you will need to fill in Cincoze RMA Request Form and obtain an RMA number from us. Our staff is available at any time to provide you with the most friendly and immediate service.

## ■ RMA Instruction

- Customers must fill in Cincoze Return Merchandise Authorization (RMA) Request Form and obtain an RMA number prior to returning a defective product to Cincoze for service.
- Customers must collect all the information about the problems encountered and note anything abnormal and describe the problems on the “Cincoze Service Form” for the RMA number apply process.
- Charges may be incurred for certain repairs. Cincoze will charge for repairs to products whose warranty period has expired. Cincoze will also charge for repairs to products if the damage resulted from acts of God, environmental or atmospheric disturbances, or other external forces through misuse, abuse, or unauthorized alteration or repair. If charges will be incurred for a repair, Cincoze lists all charges, and will wait for customer’s approval before performing the repair.
- Customers agree to ensure the product or assume the risk of loss or damage during transit, to prepay shipping charges, and to use the original shipping container or equivalent.
- Customers can be sent back the faulty products with or without accessories (manuals, cable, etc.) and any components from the system. If the components were suspected as part of the problems, please note clearly which components are included. Otherwise, Cincoze is not responsible for the devices/parts.
- Repaired items will be shipped along with a "Repair Report" detailing the findings and actions taken.

## **Limitation of Liability**

Cincoze’ liability arising out of the manufacture, sale, or supplying of the product and its use, whether based on warranty, contract, negligence, product liability, or otherwise, shall not exceed the original selling price of the product. The remedies provided herein are the customer’s sole and exclusive remedies. In no event shall Cincoze be liable for direct, indirect, special or consequential damages whether based on contract of any other legal theory.

## Technical Support and Assistance

1. Visit the Cincoze website at [www.cincoze.com](http://www.cincoze.com) where you can find the latest information about the product.
2. Contact your distributor or our technical support team or sales representative for technical support if you need additional assistance. Please have following information ready before you call:
  - Product name and serial number
  - Description of your peripheral attachments
  - Description of your software (operating system, version, application software, etc.)
  - A complete description of the problem
  - The exact wording of any error messages

## Conventions Used in this Manual



**WARNING**

This indication alerts operators to an operation that, if not strictly observed, may result in severe injury.



**CAUTION**

This indication alerts operators to an operation that, if not strictly observed, may result in safety hazards to personnel or damage to equipment.



**NOTE**

This indication provides additional information to complete a task easily.



## Safety Precautions

Before installing and using this device, please note the following precautions.

1. Read these safety instructions carefully.
2. Keep this User's Manual for future reference.
3. Disconnect this equipment from any AC outlet before cleaning.
4. For plug-in equipment, the power outlet socket must be located near the equipment and must be easily accessible.
5. Keep this equipment away from humidity.
6. Put this equipment on a reliable surface during installation. Dropping it or letting it fall may cause damage.
7. Make sure the voltage of the power source is correct before connecting the equipment to the power outlet.
8. Use a power cord that has been approved for using with the product and that it matches the voltage and current marked on the product's electrical range label. The voltage and current rating of the cord must be greater than the voltage and current rating marked on the product.
9. Position the power cord so that people cannot step on it. Do not place anything over the power cord.
10. All cautions and warnings on the equipment should be noted.
11. If the equipment is not used for a long time, disconnect it from the power source to avoid damage by transient overvoltage.
12. Never pour any liquid into an opening. This may cause fire or electrical shock.
13. Never open the equipment. For safety reasons, the equipment should be opened only by qualified service personnel.

If one of the following situations arises, get the equipment checked by service personnel:

- The power cord or plug is damaged.
  - Liquid has penetrated into the equipment.
  - The equipment has been exposed to moisture.
  - The equipment does not work well, or you cannot get it work according to the user's manual.
  - The equipment has been dropped and damaged.
  - The equipment has obvious signs of breakage.
14. CAUTION: Danger of explosion if battery is incorrectly replaced. Replace only with the same or equivalent type recommended by the manufacturer.
  15. Equipment intended only for use in a RESTRICTED ACCESS AREA.
  16. Ensure to connect the power cord of power adapter to a socket-outlet with earthing connection.
  17. Dispose of used battery promptly. Keep away from children. Do not disassemble and do not dispose of in fire.

## Package Contents

Before installation, please ensure all the items listed in the following table are included in the package.

Item	Description	Q'ty
1	CO-100/P2202 Series Panel PC	1
2	Power Terminal Block Connector	1
3	PCI / PCIe Card Installation Kit	1
4	Thermal Pad (for CPU Thermal Block)	1
5	Screw Pack	5
6	Remote Power On/Off Terminal Block Connector	1
7	DIO Terminal Block Connector	2

*Note: Notify your sales representative if any of the above items are missing or damaged.*

## Ordering Information

### Available Models

Model No.	Product Description
CO-119C-R10/P2202-i5-R10	19" TFT-LCD SXGA 5:4 Open Frame Display Modular Panel PC with 12th Gen. Intel® Core™ i5-1245UE Processor and Projected Capacitive Touch
CO-119C-R10/P2202E-i5-R10	19" TFT-LCD SXGA 5:4 Open Frame Display Modular and Expandable Panel PC with 12th Gen. Intel® Core™ i5-1245UE Processor and Projected Capacitive Touch
CO-119C-R10/P2202-i3-R10	19" TFT-LCD SXGA 5:4 Open Frame Display Modular Panel PC with 12th Gen. Intel® Core™ i3-1215UE Processor and Projected Capacitive Touch
CO-119C-R10/P2202E-i3-R10	19" TFT-LCD SXGA 5:4 Open Frame Display Modular and Expandable Panel PC with 12th Gen. Intel® Core™ i3-1215UE Processor and Projected Capacitive Touch
CO-W121C-R10/P2202-i5-R10	21.5" TFT-LCD Full HD 16:9 Open Frame Display Modular Panel PC with 12th Gen. Intel® Core™ i5-1245UE Processor and Projected Capacitive Touch
CO-W121C-R10/P2202E-i5-R10	21.5" TFT-LCD Full HD 16:9 Open Frame Display Modular and Expandable Panel PC with 12th Gen. Intel® Core™ i5-1245UE Processor and Projected Capacitive Touch
CO-W121C-R10/P2202-i3-R10	21.5" TFT-LCD Full HD 16:9 Open Frame Display Modular Panel PC with 12th Gen. Intel® Core™ i3-1215UE Processor and Projected Capacitive Touch

---

CO-W121C-R10/P2202E-i3-R10

21.5" TFT-LCD Full HD 16:9 Open Frame Display Modular  
and Expandable Panel PC with 12th Gen. Intel® Core™  
i3-1215UE Processor and Projected Capacitive Touch

---



# **Chapter 1**

## **Product Introductions**

# 1.1 Overview

Cincoze open-frame high-performance industrial panel PC (CO-100/P2202) is equipped with an Intel® Core™ U-series (Alder Lake-P) processor, rich I/O interfaces (1 GbE LAN, USB 3.2 Gen 2x1, COM, DIO, etc.), and flexible expansion. The biggest highlight is its adjustable mounting bracket design (Patent No.: I802427) that allows flexible adjustment and multi-stage locking to greatly improve the convenience of installation, effectively reducing the degree of customization required when integrating with equipment. It is purpose-built for equipment manufacturers.

- TFT-LCD with Projected Capacitive Touch
- Onboard Intel® Alder Lake-P U-Series Core™ Processor
- 2x DDR5 SO-DIMM Socket, Supports up to 4800MHz 64GB Memory
- Designed with Adjustable Mounting Bracket
- Quad Independent Display (CDS / HDMI / DP / VGA)
- 1x M.2 Key E Type 2230 Socket for Intel CNVi / Wireless Module
- Front Panel IP65 Compliant



## Excellent Computing Performance

The CO-100/P2202 series is equipped with the 12th Gen Intel® Core™ i5/i3 U-series (Alder Lake-P) processor based on the Intel® 7 process. The U-series has a low power consumption of only 15W, boasts excellent performance with up to 10 cores (2P+8E), and includes the built-in Intel® Iris Xe graphics to easily handle image classification inference performance in AI deep learning

### i5 Processor



### i3 Processor



## CDS Patented Technology

Cincoze Convertible Display System (CDS) patented technology makes field-side maintenance and future upgrades easier. Replacing a display or improving system performance only requires replacing a single component, which significantly cuts upgrade costs.

Patent No. M482908

## Easy to Install

The exclusive adjustable mounting bracket (Patent No.: I802427) has thickness adjustment options and supports multiple locking methods (panel and boss types), providing a simpler and more convenient integration for industrial machines using flat mount and standard mount.

Patent No. I802427, D224544, D224545





### Integrated Structure

The flexible and reliable design of the open-frame architecture enables deployment in equipment machines, and after removing the mounting bracket can be installed directly using the VESA mount for standalone use, or installed in a 19" rack for display function.

---

### Rugged, Safe, Reliable

The CO-100/P2202 series features a series of industrial-grade protections, such as a fanless design, wide operating temperature range (0°C to 60°C), wide range DC power input (9 to 48VDC), and IP65 dustproof/water resistant front panel for field-side HMI applications in harsh industrial environments.



# 1.2 Specifications

## 1.2.1 CO-119C-R10/P2202 Series

Model Name	CO-119C
<b>Display</b>	
LCD Size	• 19" (5:4)
Resolution	• 1280 x 1024
Brightness	• 350 cd/m2
Contract Ratio	• 1000:1
LCD Color	• 16.7M
Pixel Pitch	• 0.294(H) x 0.294(V)
Viewing Angle	• 170 (H) / 160 (V)
Backlight MTBF	• 50,000 hrs (LED Backlight)
<b>Touchscreen</b>	
Touchscreen Type	• Projected Capacitive Touch
<b>Physical</b>	
Dimension (WxDxH)	• 472.8 x 397.5 x 63 mm
Weight	• 6.91KG
Construction	• One-piece and Slim Bezel Design
Mounting Type	• Flat / Standard / VESA / Rack Mount
Mounting Bracket	• Pre-installed Mounting Bracket with Adjustable Design ( Support 11 different stages of adjustment)
<b>Protection</b>	
Ingress Protection	• Front Panel IP65 Compliant * According to IEC60529
<b>Environment</b>	
Operating Temperature	• 0°C to 50°C (with Industrial Grade peripherals; Ambient with air flow)
Storage Temperature	• -20°C to 60°C
Humidity	• 80% RH @ 50°C (non-condensing)
EMC	• CE, UKCA, FCC, ICES-003 Class A
EMI	• CISPR 32 Conducted & Radiated: Class A • EN/BS EN 55032 Conducted & Radiated: Class A • EN/BS EN IEC 61000-3-2 Harmonic current emissions: Class A • EN/BS EN61000-3-3 Voltage fluctuations & flicker • FCC 47 CFR Part 15B, ICES-003 Conducted & Radiated: Class A
EMS	• EN/IEC 61000-4-2 ESD: Contact: 4 kV; Air: 8 kV • EN/IEC 61000-4-3 RS: 80 MHz to 1000 MHz: 3 V/m • EN/IEC 61000-4-4 EFT: AC Power: 1 kV; DC Power: 0.5 kV; Signal: 0.5 kV • EN/IEC 61000-4-5 Surges: AC Power: 2 kV; Signal: 1 kV

- EN/IEC 61000-4-6 CS: 3V
- EN/IEC 61000-4-8 PFMF: 50 Hz, 1A/m
- EN/IEC 61000-4-11 Voltage Dips & Voltage Interruptions: 0.5 cycles at 50 Hz

Model Name	P2202	P2202E
<b>System</b>		
Processor	<ul style="list-style-type: none"> <li>• Onboard 12th Generation Intel® Alder Lake-P U-Series CPU:               <ul style="list-style-type: none"> <li>- Intel® Core™ i5-1245UE 10 Cores Up to 4.40 GHz, TDP 15W</li> <li>- Intel® Core™ i3-1215UE 6 Cores Up to 4.40 GHz, TDP 15W</li> </ul> </li> </ul>	
Memory	<ul style="list-style-type: none"> <li>• 2x DDR5 4800MHz SO-DIMM Socket</li> <li>Supports Un-buffered and non-ECC Type, Up to 64GB</li> </ul>	
BIOS	<ul style="list-style-type: none"> <li>• AMI BIOS</li> </ul>	
<b>Graphics</b>		
Graphics Engine	<ul style="list-style-type: none"> <li>• Integrated Intel® Iris® Xe Graphics: Core™ i5-1245UE</li> <li>• Integrated Intel® UHD Graphics: Core™ i3-1215UE</li> </ul>	
Maximum Display Output	<ul style="list-style-type: none"> <li>• Supports Quad Independent Display</li> </ul>	
CDS	<ul style="list-style-type: none"> <li>• 1x CDS Connector (1920 x 1080 @60Hz)</li> </ul>	
DP	<ul style="list-style-type: none"> <li>• 1x DisplayPort Connector (4096 x 2304 @60Hz)</li> <li>* Verified maximum resolution: 3840 x 2160 @ 60Hz</li> </ul>	
HDMI	<ul style="list-style-type: none"> <li>• 1x HDMI Connector (3840 x 2160 @30Hz)</li> </ul>	
VGA	<ul style="list-style-type: none"> <li>• 1x VGA Connector (1920 x 1200 @60Hz)</li> </ul>	
<b>Audio</b>		
Audio Codec	<ul style="list-style-type: none"> <li>• Realtek® ALC888, High Definition Audio</li> </ul>	
Line-out	<ul style="list-style-type: none"> <li>• 1x Line-out, Phone Jack 3.5mm</li> </ul>	
Mic-in	<ul style="list-style-type: none"> <li>• 1x Mic-in, Phone Jack 3.5mm</li> </ul>	
<b>I/O</b>		
LAN	<ul style="list-style-type: none"> <li>• 2x 1GbE LAN, RJ45               <ul style="list-style-type: none"> <li>- GbE1: Intel® I219</li> <li>- GbE2: Intel® I210</li> </ul> </li> </ul>	
COM	<ul style="list-style-type: none"> <li>• 4x RS-232/422/485 with Auto Flow Control (Supports 5V/12V), DB9</li> </ul>	
USB	<ul style="list-style-type: none"> <li>• 3x 10Gbps USB 3.2 Gen2x1, Type A</li> <li>• 1x 480Mbps USB 2.0, Type A</li> </ul>	
DIO	<ul style="list-style-type: none"> <li>• 16x Isolated Digital I/O (8in/8out), 20-Pin Terminal Block</li> </ul>	
<b>Storage</b>		
SSD/HDD	<ul style="list-style-type: none"> <li>• 2x 2.5" SATA HDD/SSD Bay (SATA3.0)</li> </ul>	
RAID	<ul style="list-style-type: none"> <li>• Support RAID 0/1</li> </ul>	
<b>Expansion</b>		
Mini PCI Express	<ul style="list-style-type: none"> <li>• 2x Full-size Mini-PCIe Socket</li> </ul>	
PCI Express	--	<ul style="list-style-type: none"> <li>• 1x PCI or 1x PCIe x4 Expansion slot (with</li> </ul>



		Optional Riser Card) * Supports maximum dimensions of add-on card (H x L):169 x 111mm
SIM Socket	<ul style="list-style-type: none"> <li>1x SIM Socket</li> </ul>	
M.2	<ul style="list-style-type: none"> <li>1x M.2 Key E Type 2230 Socket, Support Intel CNVi/Wireless Module</li> </ul>	
CFM (Control Function Module) Interface	<ul style="list-style-type: none"> <li>1x CFM Interface for optional IGN Module Expansion</li> <li>1x CFM Interface for optional PoE Module Expansion</li> </ul>	
CDS (Convertible Display System) Interface	<ul style="list-style-type: none"> <li>1x CDS Interface for Convertible Display Module</li> </ul>	
<b>Other Function</b>		
Clear CMOS Switch	<ul style="list-style-type: none"> <li>1x Clear CMOS Switch</li> </ul>	
Reset Button	<ul style="list-style-type: none"> <li>1x Reset Button</li> </ul>	
Instant Reboot	<ul style="list-style-type: none"> <li>Support 0.2sec Instant Reboot Technology</li> </ul>	
Watchdog Timer	<ul style="list-style-type: none"> <li>Software Programmable Supports 256 Levels System Reset</li> </ul>	
OSD Button	<ul style="list-style-type: none"> <li>LCD On/Off, Brightness Up, Brightness Down</li> </ul>	
Internal Speaker	<ul style="list-style-type: none"> <li>AMP 2W + 2W</li> </ul>	
Status LED Indicator	<ul style="list-style-type: none"> <li>Power LED, HDD LED</li> </ul>	
<b>Power</b>		
Power Button	<ul style="list-style-type: none"> <li>1x ATX Power On/Off Button</li> </ul>	
Power Mode Switch	<ul style="list-style-type: none"> <li>1x AT/ATX Mode Switch</li> </ul>	
Power Input	<ul style="list-style-type: none"> <li>9 - 48VDC, 3-pin Terminal Block</li> </ul>	
Remote Power On/Off	<ul style="list-style-type: none"> <li>1x Remote Power On/Off, 2-pin Terminal Block</li> </ul>	
<b>Operating System</b>		
Windows	<ul style="list-style-type: none"> <li>Windows® 10</li> </ul>	
Linux	<ul style="list-style-type: none"> <li>Supports by project</li> </ul>	
<b>Physical</b>		
Dimension (W x D x H)	<ul style="list-style-type: none"> <li>254.5 X 190 X 41.5 mm</li> </ul>	<ul style="list-style-type: none"> <li>254.5 x 190 x 61 mm</li> </ul>
Weight Information	<ul style="list-style-type: none"> <li>2.22 kg</li> </ul>	<ul style="list-style-type: none"> <li>2.74 kg</li> </ul>
Mechanical Construction	<ul style="list-style-type: none"> <li>Extruded Aluminum with Heavy Duty Metal</li> </ul>	
Mounting	<ul style="list-style-type: none"> <li>Wall / VESA / CDS / DIN Rail</li> </ul>	
Physical Design	<ul style="list-style-type: none"> <li>Fanless Design</li> <li>Jumper-less Design</li> </ul>	
<b>Reliability &amp; Protection</b>		
Reverse Power Input Protection	<ul style="list-style-type: none"> <li>Yes</li> </ul>	
Over Voltage Protection	<ul style="list-style-type: none"> <li>Protection Range: 51-58V</li> <li>Protection Type: shut down operating voltage, re-power on at the present level to recover</li> </ul>	
Over Current Protection	<ul style="list-style-type: none"> <li>15A</li> </ul>	
CMOS Battery Backup	<ul style="list-style-type: none"> <li>SuperCap Integrated for CMOS Battery Maintenance-free Operation</li> </ul>	

MTBF	<ul style="list-style-type: none"> <li>216,747 Hours - Database: Telcordia SR-332 Issue3, Method 1, Case 3</li> </ul>
<b>Environment</b>	
Operating Temperature	<ul style="list-style-type: none"> <li>-40°C to 70°C</li> <li>- With extended temperature peripherals; Ambient with air flow</li> <li>- According to IEC60068-2-1, IEC60068-2-2, IEC60068-2-14</li> </ul>
Storage Temperature	<ul style="list-style-type: none"> <li>-40°C to 70°C</li> </ul>
Relative Humidity	<ul style="list-style-type: none"> <li>95%RH @ 70°C (non-Condensing)</li> </ul>
Shock	<ul style="list-style-type: none"> <li>Operating, 50 Grms (w/ SSD, according to IEC60068-2-27)</li> </ul>
Vibration	<ul style="list-style-type: none"> <li>Operating, 1 Grms, 10-500 Hz, 3 Axes (w/ SSD, according to IEC60068-2-6)</li> <li>Operating, 5 Grms, 5-500 Hz, 3 Axes (w/ SSD, according to IEC60068-2-64)</li> </ul>
EMC	<ul style="list-style-type: none"> <li>CE, UKCA, FCC, ICES-003 Class A</li> <li>EN IEC 61000-6-4, EN61000-6-2 (24VDC Input Only)</li> </ul>
EMI	<ul style="list-style-type: none"> <li>CISPR 32 Conducted &amp; Radiated: Class A</li> <li>EN/BS EN 55032 Conducted &amp; Radiated: Class A</li> <li>EN/BS EN IEC 61000-3-2 Harmonic current emissions: Class A</li> <li>EN/BS EN61000-3-3 Voltage fluctuations &amp; flicker</li> <li>FCC 47 CFR Part 15B, ICES-003 Conducted &amp; Radiated: Class A</li> </ul>
EMS	<ul style="list-style-type: none"> <li>EN/IEC 61000-4-2 ESD: Contact: 4 kV; Air: 8 kV</li> <li>EN/IEC 61000-4-3 RS: 80 MHz to 1000 MHz: 10 V/m</li> <li>EN/IEC 61000-4-4 EFT: AC Power: 2 kV; DC Power: 1 kV; Signal: 1 kV</li> <li>EN/IEC 61000-4-5 Surges: AC Power: 2 kV; Signal: 1 kV</li> <li>EN/IEC 61000-4-6 CS: 10V</li> <li>EN/IEC 61000-4-8 PFMF: 50 Hz, 30A/m</li> <li>EN/IEC 61000-4-11 Voltage Dips &amp; Voltage Interruptions: 1 cycles at 60 Hz</li> </ul>

*\* Product Specifications and features are for reference only and are subject to change without prior notice. For more information, please refer to the latest product datasheet from Cincoze's website.*

# Dimension

CO-119C/P2202

Unit: mm

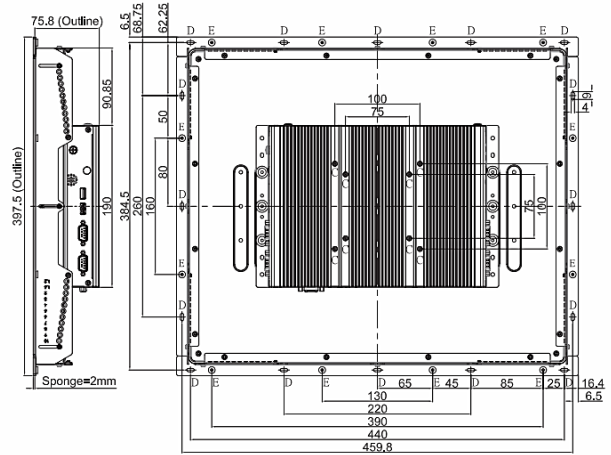
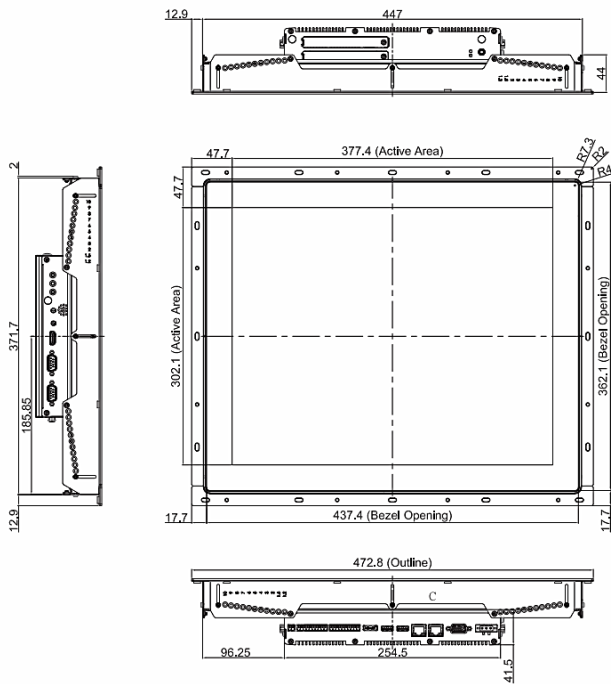

NOTE:  
 1.C=8\_M4 VESA Screw holes(5 mm Length Limits)  
 2.D=16\_9\*4 Oblong Hole  
 3.E=12\_M4 Screw Hole

CO-119C/P2202E

Unit: mm

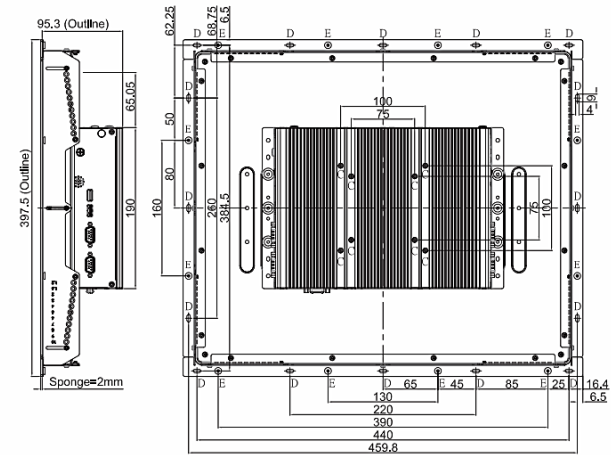
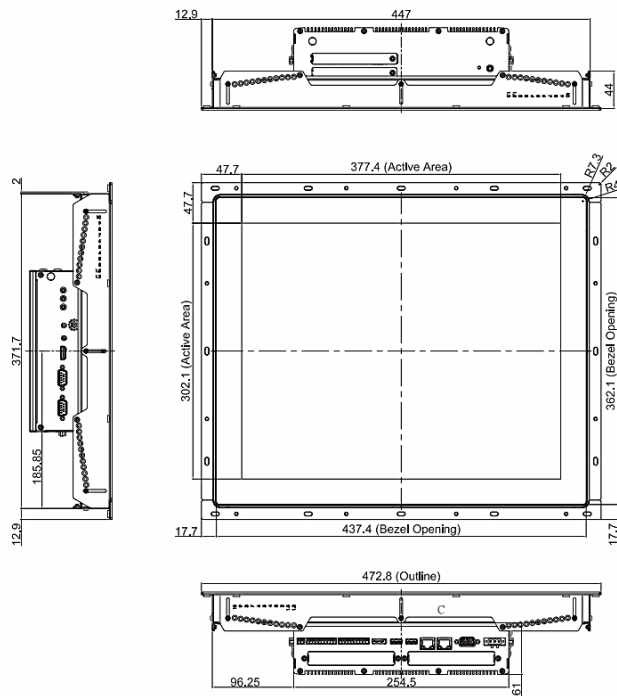

NOTE:  
 1.C=8\_M4 VESA Screw holes(5 mm Length Limits)  
 2.D=16\_9\*4 Oblong Hole  
 3.E=12\_M4 Screw Hole

## 1.2.2 CO-W121C-R10/P2202 Series

Model Name	CO-W121C
<b>Display</b>	
LCD Size	• 21.5" (16:9)
Resolution	• 1920 x 1080
Brightness	• 300 cd/m2
Contract Ratio	• 5000:1
LCD Color	• 16.7M
Pixel Pitch	• 0.24825(H) x 0.24825(V) mm
Viewing Angle	• 178 (H) / 178 (V)
Backlight MTBF	• 50,000 hrs
<b>Touchscreen</b>	
Touchscreen Type	• Projected Capacitive Touch
<b>Physical</b>	
Dimension (WxDxH)	• 550 x 343.7 x 63.3
Weight	• 7.16KG
Construction	• One-piece and Slim Bezel Design
Mounting Type	• Flat / Standard / VESA / Rack Mount
Mounting Bracket	• Pre-installed Mounting Bracket with Adjustable Design ( Support 11 different stages of adjustment)
<b>Protection</b>	
Ingress Protection	• Front Panel IP65 Compliant  * According to IEC60529
<b>Environment</b>	
Operating Temperature	• 0°C to 60°C (with Industrial Grade peripherals; Ambient with air flow)
Storage Temperature	• -20°C to 60°C
Humidity	• 80% RH @ 50°C (non-condensing)
EMC	• CE, UKCA, FCC, ICES-003 Class A
EMI	• CISPR 32 Conducted & Radiated: Class A • EN/BS EN 55032 Conducted & Radiated: Class A • EN/BS EN IEC 61000-3-2 Harmonic current emissions: Class A • EN/BS EN61000-3-3 Voltage fluctuations & flicker • FCC 47 CFR Part 15B, ICES-003 Conducted & Radiated: Class A
EMS	• EN/IEC 61000-4-2 ESD: Contact: 4 kV; Air: 8 kV • EN/IEC 61000-4-3 RS: 80 MHz to 1000 MHz: 3 V/m • EN/IEC 61000-4-4 EFT: AC Power: 1 kV; DC Power: 0.5 kV; Signal: 0.5 kV • EN/IEC 61000-4-5 Surges: AC Power: 2 kV; Signal: 1 kV • EN/IEC 61000-4-6 CS: 3V • EN/IEC 61000-4-8 PFMF: 50 Hz, 1A/m

	<ul style="list-style-type: none"> <li>EN/IEC 61000-4-11 Voltage Dips &amp; Voltage Interruptions: 0.5 cycles at 50 Hz</li> </ul>
Safety	<ul style="list-style-type: none"> <li>UL, cUL, CB, IEC, EN 62368-1</li> </ul>

Model Name	P2202	P2202E
<b>System</b>		
Processor	<ul style="list-style-type: none"> <li>Onboard 12th Generation Intel® Alder Lake-P U-Series CPU: <ul style="list-style-type: none"> <li>Intel® Core™ i5-1245UE 10 Cores Up to 4.40 GHz, TDP 15W</li> <li>Intel® Core™ i3-1215UE 6 Cores Up to 4.40 GHz, TDP 15W</li> </ul> </li> </ul>	
Memory	<ul style="list-style-type: none"> <li>2x DDR5 4800MHz SO-DIMM Socket</li> <li>Supports Un-buffered and non-ECC Type, Up to 64GB</li> </ul>	
BIOS	<ul style="list-style-type: none"> <li>AMI BIOS</li> </ul>	
<b>Graphics</b>		
Graphics Engine	<ul style="list-style-type: none"> <li>Integrated Intel® Iris® Xe Graphics: Core™ i5-1245UE</li> <li>Integrated Intel® UHD Graphics: Core™ i3-1215UE</li> </ul>	
Maximum Display Output	<ul style="list-style-type: none"> <li>Supports Quad Independent Display</li> </ul>	
CDS	<ul style="list-style-type: none"> <li>1x CDS Connector (1920 x 1080 @60Hz)</li> </ul>	
DP	<ul style="list-style-type: none"> <li>1x DisplayPort Connector (4096 x 2304 @60Hz)</li> <li>* Verified maximum resolution: 3840 x 2160 @ 60Hz</li> </ul>	
HDMI	<ul style="list-style-type: none"> <li>1x HDMI Connector (3840 x 2160 @30Hz)</li> </ul>	
VGA	<ul style="list-style-type: none"> <li>1x VGA Connector (1920 x 1200 @60Hz)</li> </ul>	
<b>Audio</b>		
Audio Codec	<ul style="list-style-type: none"> <li>Realtek® ALC888, High Definition Audio</li> </ul>	
Line-out	<ul style="list-style-type: none"> <li>1x Line-out, Phone Jack 3.5mm</li> </ul>	
Mic-in	<ul style="list-style-type: none"> <li>1x Mic-in, Phone Jack 3.5mm</li> </ul>	
<b>I/O</b>		
LAN	<ul style="list-style-type: none"> <li>2x 1GbE LAN, RJ45 <ul style="list-style-type: none"> <li>GbE1: Intel® I219</li> <li>GbE2: Intel® I210</li> </ul> </li> </ul>	
COM	<ul style="list-style-type: none"> <li>4x RS-232/422/485 with Auto Flow Control (Supports 5V/12V), DB9</li> </ul>	
USB	<ul style="list-style-type: none"> <li>3x 10Gbps USB 3.2 Gen2x1, Type A</li> <li>1x 480Mbps USB 2.0, Type A</li> </ul>	
DIO	<ul style="list-style-type: none"> <li>16x Isolated Digital I/O (8in/8out), 20-Pin Terminal Block</li> </ul>	
<b>Storage</b>		
SSD/HDD	<ul style="list-style-type: none"> <li>2x 2.5" SATA HDD/SSD Bay (SATA3.0)</li> </ul>	
RAID	<ul style="list-style-type: none"> <li>Support RAID 0/1</li> </ul>	
<b>Expansion</b>		
Mini PCI Express	<ul style="list-style-type: none"> <li>2x Full-size Mini-PCIe Socket</li> </ul>	
PCI Express	--	<ul style="list-style-type: none"> <li>1x PCI or 1x PCIe x4 Expansion slot (with Optional Riser Card)</li> </ul>

		* Supports maximum dimensions of add-on card (H x L):169 x 111mm
SIM Socket	<ul style="list-style-type: none"> <li>1x SIM Socket</li> </ul>	
M.2	<ul style="list-style-type: none"> <li>1x M.2 Key E Type 2230 Socket, Support Intel CNVi/Wireless Module</li> </ul>	
CFM (Control Function Module) Interface	<ul style="list-style-type: none"> <li>1x CFM Interface for optional IGN Module Expansion</li> <li>1x CFM Interface for optional PoE Module Expansion</li> </ul>	
CDS (Convertible Display System) Interface	<ul style="list-style-type: none"> <li>1x CDS Interface for Convertible Display Module</li> </ul>	
<b>Other Function</b>		
Clear CMOS Switch	<ul style="list-style-type: none"> <li>1x Clear CMOS Switch</li> </ul>	
Reset Button	<ul style="list-style-type: none"> <li>1x Reset Button</li> </ul>	
Instant Reboot	<ul style="list-style-type: none"> <li>Support 0.2sec Instant Reboot Technology</li> </ul>	
Watchdog Timer	<ul style="list-style-type: none"> <li>Software Programmable Supports 256 Levels System Reset</li> </ul>	
OSD Button	<ul style="list-style-type: none"> <li>LCD On/Off, Brightness Up, Brightness Down</li> </ul>	
Internal Speaker	<ul style="list-style-type: none"> <li>AMP 2W + 2W</li> </ul>	
Status LED Indicator	<ul style="list-style-type: none"> <li>Power LED, HDD LED</li> </ul>	
<b>Power</b>		
Power Button	<ul style="list-style-type: none"> <li>1x ATX Power On/Off Button</li> </ul>	
Power Mode Switch	<ul style="list-style-type: none"> <li>1x AT/ATX Mode Switch</li> </ul>	
Power Input	<ul style="list-style-type: none"> <li>9 - 48VDC, 3-pin Terminal Block</li> </ul>	
Remote Power On/Off	<ul style="list-style-type: none"> <li>1x Remote Power On/Off, 2-pin Terminal Block</li> </ul>	
<b>Operating System</b>		
Windows	<ul style="list-style-type: none"> <li>Windows® 10</li> </ul>	
Linux	<ul style="list-style-type: none"> <li>Supports by project</li> </ul>	
<b>Physical</b>		
Dimension (W x D x H)	<ul style="list-style-type: none"> <li>254.5 X 190 X 41.5 mm</li> </ul>	<ul style="list-style-type: none"> <li>254.5 x 190 x 61 mm</li> </ul>
Weight Information	<ul style="list-style-type: none"> <li>2.22 kg</li> </ul>	<ul style="list-style-type: none"> <li>2.74 kg</li> </ul>
Mechanical Construction	<ul style="list-style-type: none"> <li>Extruded Aluminum with Heavy Duty Metal</li> </ul>	
Mounting	<ul style="list-style-type: none"> <li>Wall / VESA / CDS / DIN Rail</li> </ul>	
Physical Design	<ul style="list-style-type: none"> <li>Fanless Design</li> <li>Jumper-less Design</li> </ul>	
<b>Reliability &amp; Protection</b>		
Reverse Power Input Protection	<ul style="list-style-type: none"> <li>Yes</li> </ul>	
Over Voltage Protection	<ul style="list-style-type: none"> <li>Protection Range: 51-58V</li> <li>Protection Type: shut down operating voltage, re-power on at the present level to recover</li> </ul>	
Over Current Protection	<ul style="list-style-type: none"> <li>15A</li> </ul>	
CMOS Battery Backup	<ul style="list-style-type: none"> <li>SuperCap Integrated for CMOS Battery Maintenance-free Operation</li> </ul>	
MTBF	<ul style="list-style-type: none"> <li>216,747 Hours - Database: Telcordia SR-332 Issue3, Method 1, Case 3</li> </ul>	

Environment	
Operating Temperature	<ul style="list-style-type: none"> <li>-40°C to 70°C</li> <li>- With extended temperature peripherals; Ambient with air flow</li> <li>- According to IEC60068-2-1, IEC60068-2-2, IEC60068-2-14</li> </ul>
Storage Temperature	<ul style="list-style-type: none"> <li>-40°C to 70°C</li> </ul>
Relative Humidity	<ul style="list-style-type: none"> <li>95%RH @ 70°C (non-Condensing)</li> </ul>
Shock	<ul style="list-style-type: none"> <li>Operating, 50 Grms (w/ SSD, according to IEC60068-2-27)</li> </ul>
Vibration	<ul style="list-style-type: none"> <li>Operating, 1 Grms, 10-500 Hz, 3 Axes (w/ SSD, according to IEC60068-2-6)</li> <li>Operating, 5 Grms, 5-500 Hz, 3 Axes (w/ SSD, according to IEC60068-2-64)</li> </ul>
EMC	<ul style="list-style-type: none"> <li>CE, UKCA, FCC, ICES-003 Class A</li> <li>EN IEC 61000-6-4, EN61000-6-2 (24VDC Input Only)</li> </ul>
EMI	<ul style="list-style-type: none"> <li>CISPR 32 Conducted &amp; Radiated: Class A</li> <li>EN/BS EN 55032 Conducted &amp; Radiated: Class A</li> <li>EN/BS EN IEC 61000-3-2 Harmonic current emissions: Class A</li> <li>EN/BS EN61000-3-3 Voltage fluctuations &amp; flicker</li> <li>FCC 47 CFR Part 15B, ICES-003 Conducted &amp; Radiated: Class A</li> </ul>
EMS	<ul style="list-style-type: none"> <li>EN/IEC 61000-4-2 ESD: Contact: 4 kV; Air: 8 kV</li> <li>EN/IEC 61000-4-3 RS: 80 MHz to 1000 MHz: 10 V/m</li> <li>EN/IEC 61000-4-4 EFT: AC Power: 2 kV; DC Power: 1 kV; Signal: 1 kV</li> <li>EN/IEC 61000-4-5 Surges: AC Power: 2 kV; Signal: 1 kV</li> <li>EN/IEC 61000-4-6 CS: 10V</li> <li>EN/IEC 61000-4-8 PFMF: 50 Hz, 30A/m</li> <li>EN/IEC 61000-4-11 Voltage Dips &amp; Voltage Interruptions: 1 cycles at 60 Hz</li> </ul>

*\* Product Specifications and features are for reference only and are subject to change without prior notice. For more information, please refer to the latest product datasheet from Cincoze's website.*

# Dimension

CO-W121C/P2202

Unit: mm

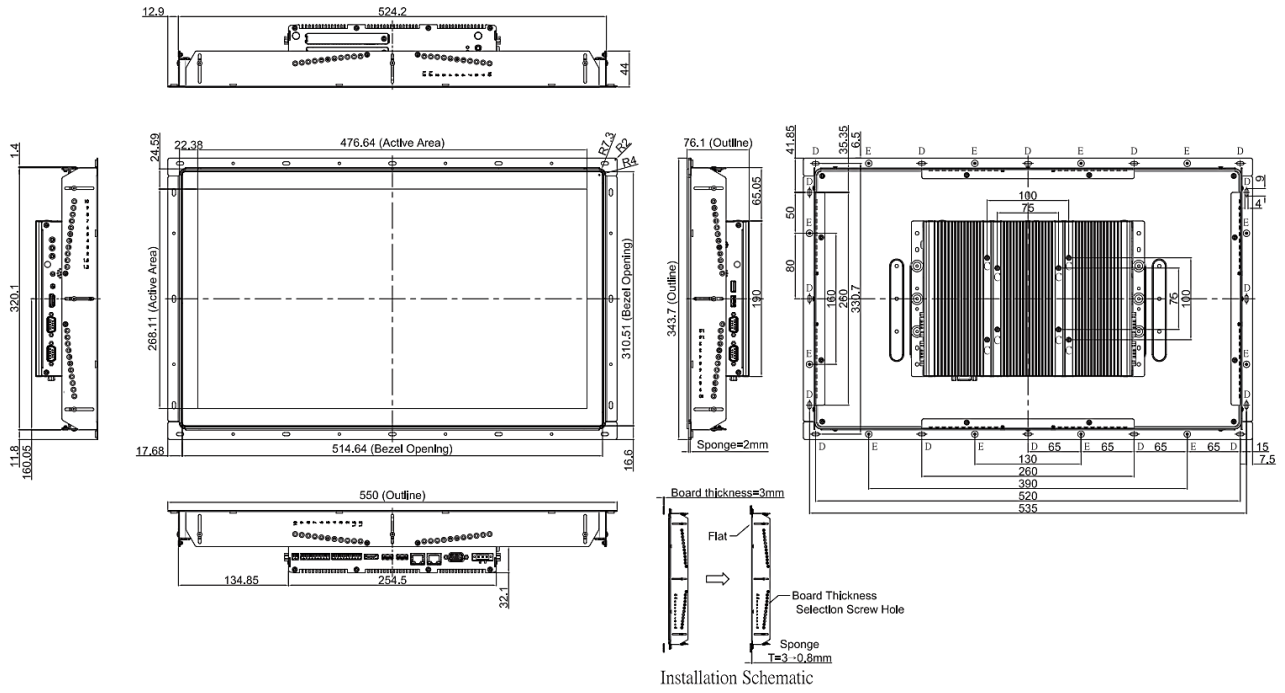

CO-W121C/P2202E

Unit: mm

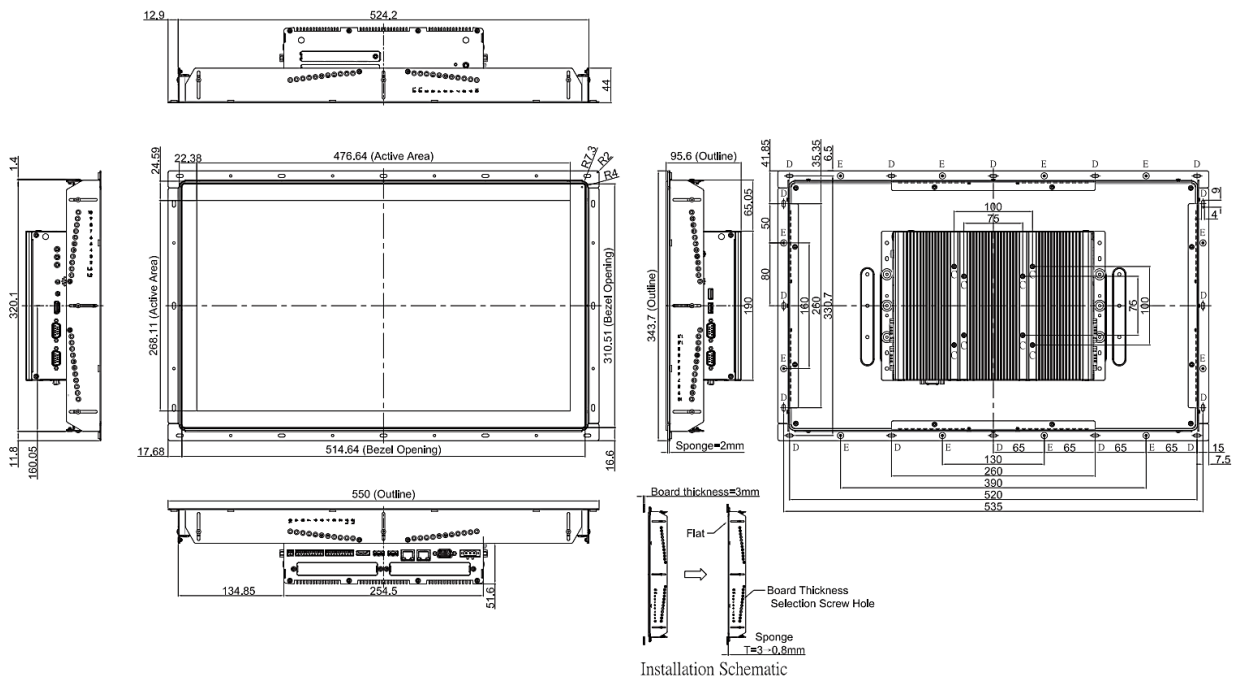



# 1.3 External Layout

## 1.3.1 Front

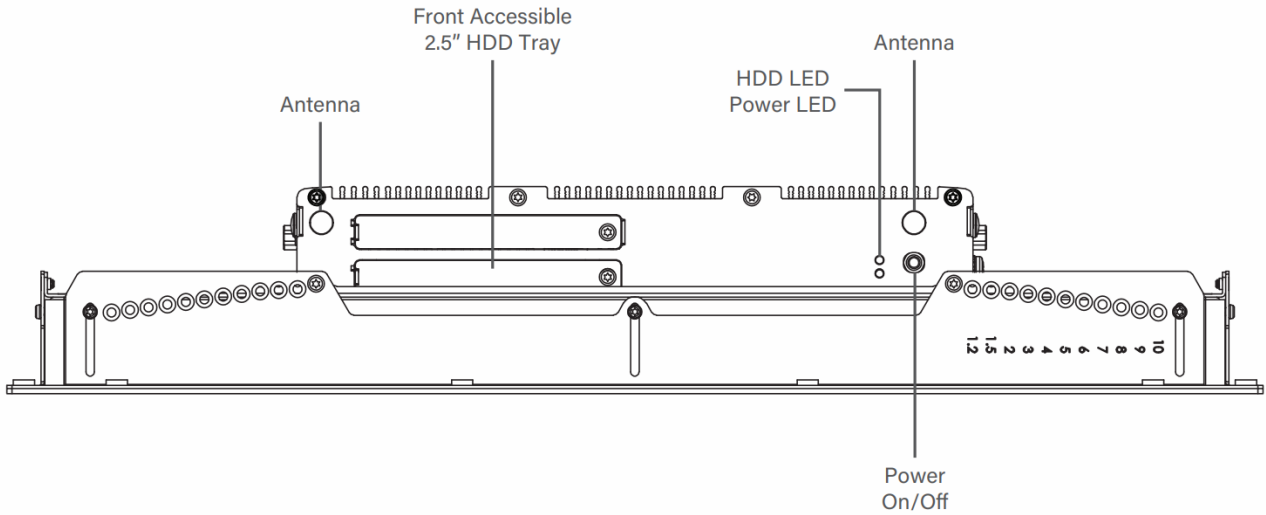

**CO-100/P2202**

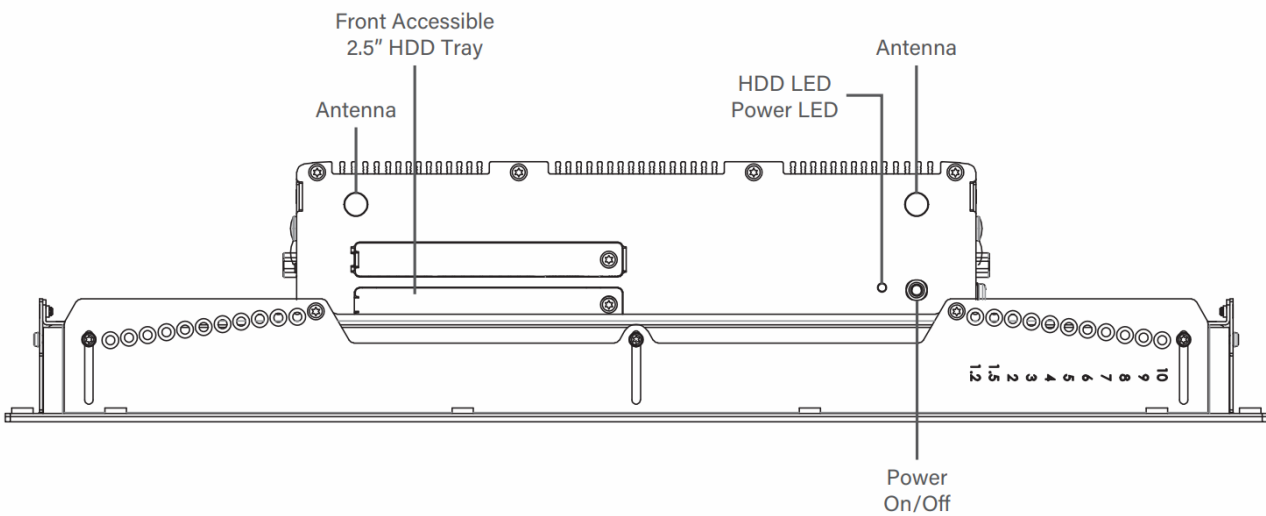

**CO-100/P2202E**

### 1.3.2 Rear

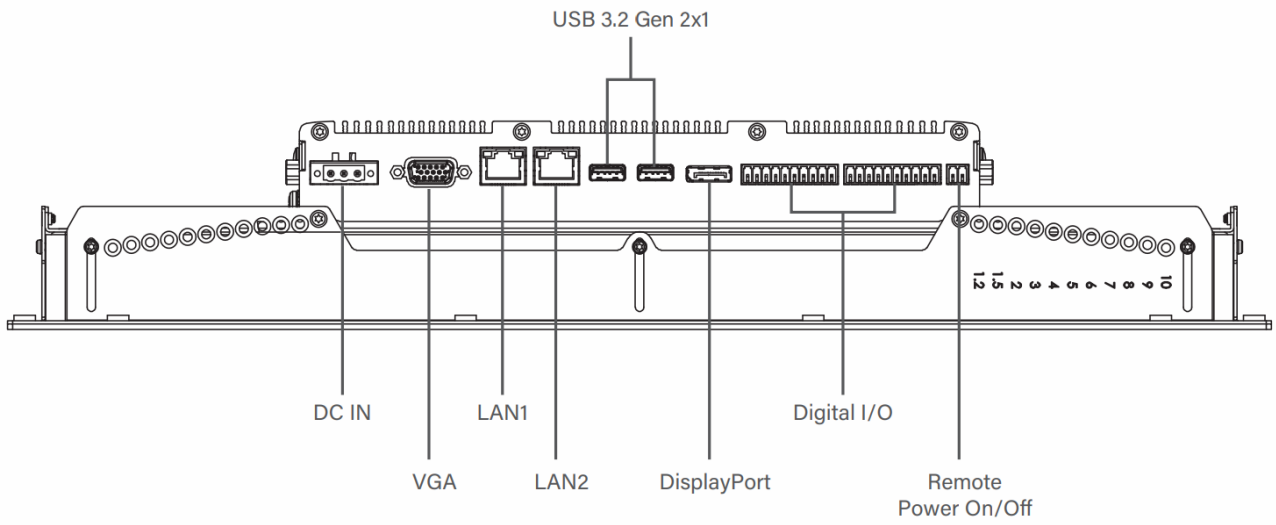

### CO-100/P2202

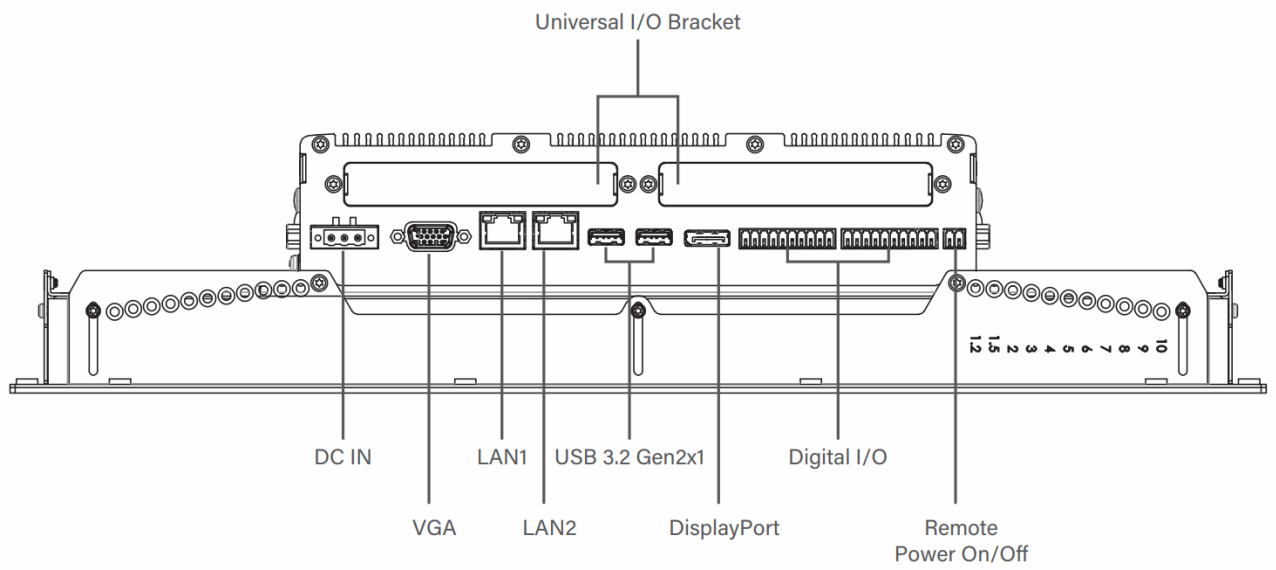

### CO-100/P2202E

### 1.3.3 Left

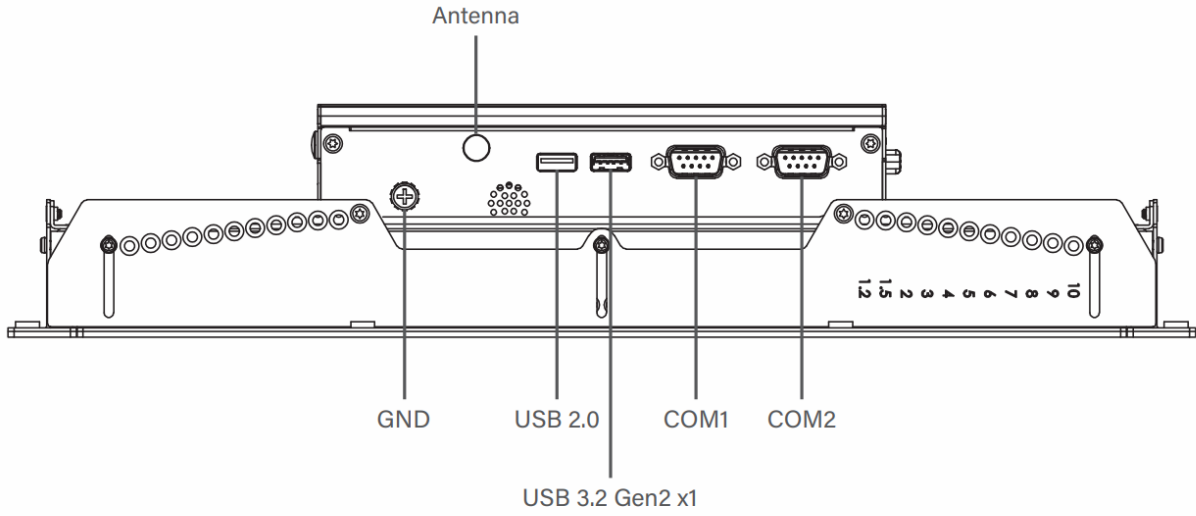

**CO-100/P2202**

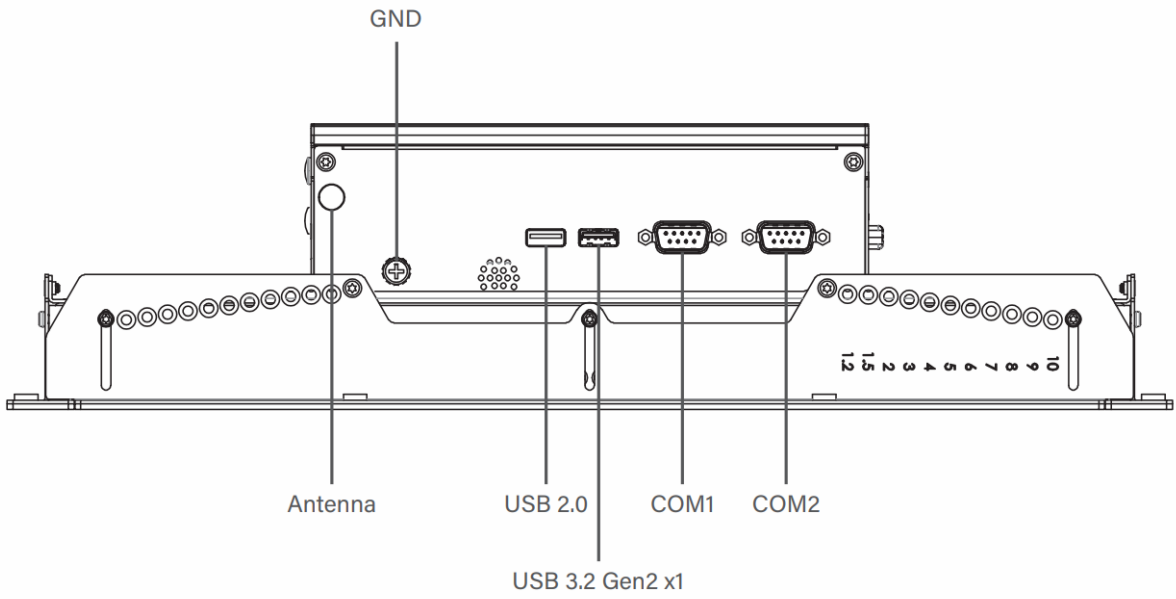

**CO-100/P2202E**

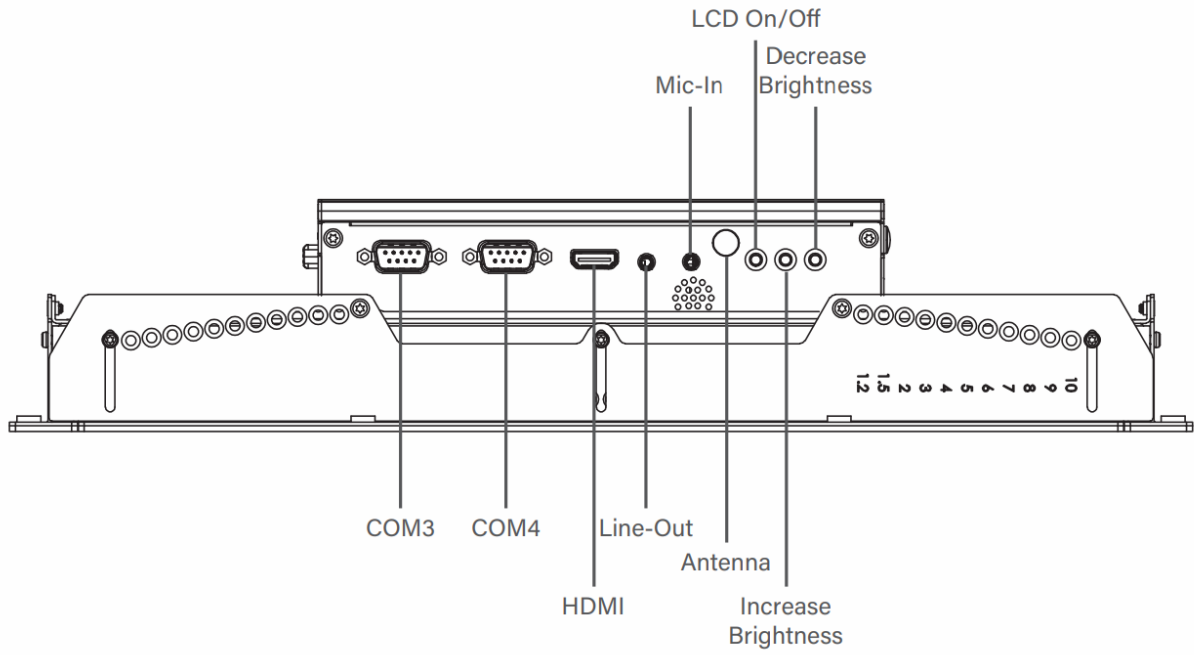

### 1.3.4 Right

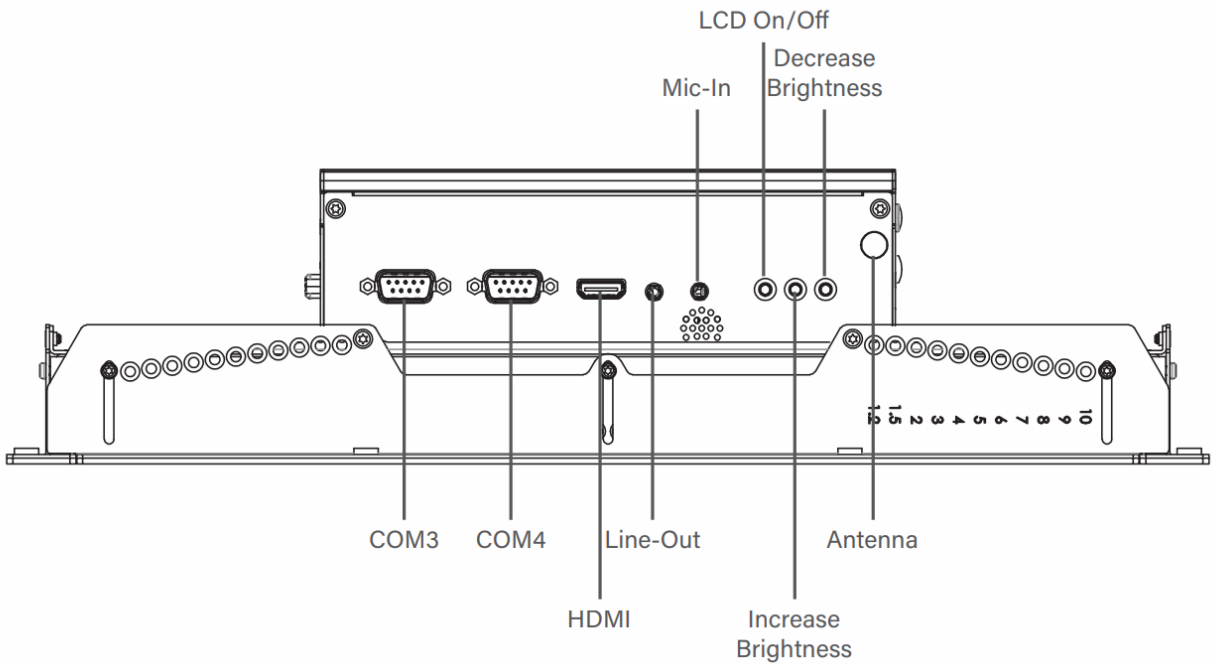

**CO-100/P2202**



**CO-100/P2202E**



# **Chapter 2**

## **Introduction to Switches and Connectors**

## 2.1 Location of Switches and Connectors

### 2.1.1 Top View

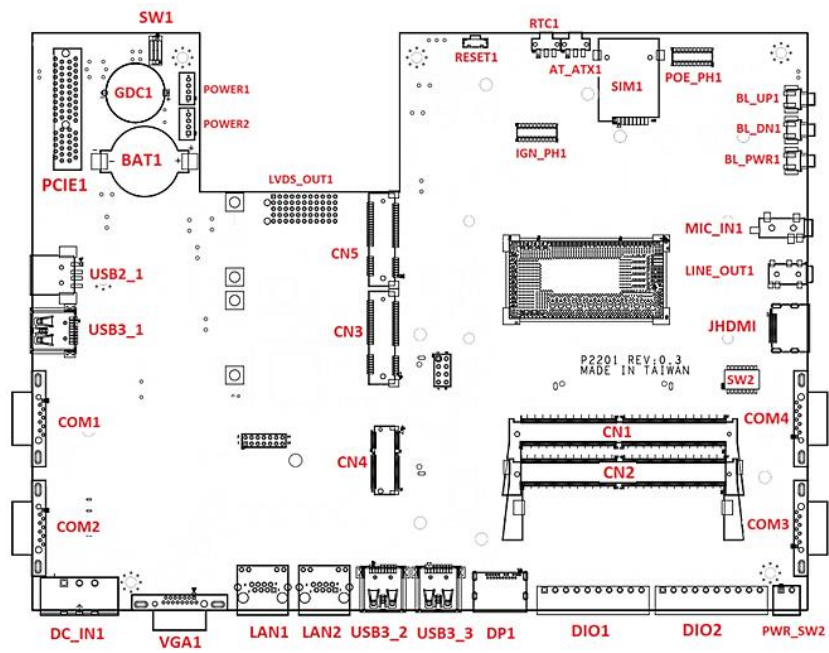

### 2.1.2 Bottom View

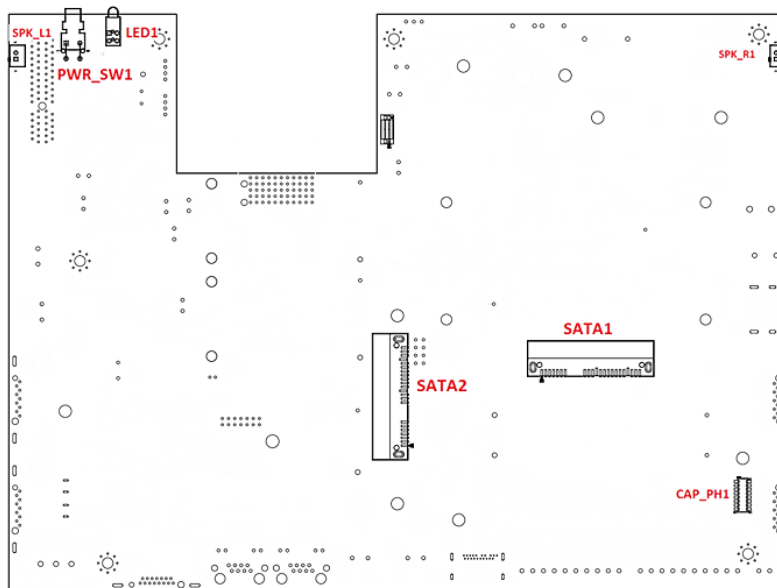

## 2.2 Switches and Connectors Definition

### List of Switches and Connectors

Location	Definition
AT_ATX1	AT / ATX Power Mode Switch
BAT1	Battery Holder
BL_DN1	Backlight Decrease Button
BL_PWR1	Backlight Power on/off Button
BL_UP1	Backlight Increase Button
CAP_PH1	CAP Board to Board Connector
CN1, CN2	DDR5 SO-DIMM Socket
CN3	Mini PCI-Express Socket (Support PCIE/ USB2.0 Interface)
CN4	M.2 Key E Socket (Support PCIE / CNVi Module)
CN5	Mini PCI-Express Socket (Support PCIE/ USB3.0/ USB2.0 Interface)
COM1, COM2, COM3, COM4	COM Connector, Support RS232 / RS422 / RS485
DC_IN1	3-pin DC 9-48V Power Input Connector, with Power Ignition Connector
DIO1	Digital 8 Output Connector
DIO2	Digital 8 Input Connector
DP1	Display Port
FS_1	DC Input Power Fuse Holder
GDC1	Super CAP for CMOS Backup
IGN_PH1	IGN Control Board Female Header
JHDMI	HDMI Connector
LAN1, LAN2	Giga LAN RJ45 Connector with i219/i210
LED1	HDD / Power LED
LINE_OUT1	Line-out Jack
LVDS_OUT1	LVDS Connector
MIC_IN1	Mic-in Jack
PCIE1	PCIEx4 Slot
POE_PH1	PSE Board Male Header
POWER1, POWER2	Power Connector, Support +5V/+12V
PWR_SW1	Power Button with Power on LED
PWR_SW2	Remote Power on/off Connector
Reset1	Reset Button
RTC1	Clear COMS Switch
SATA1, SATA2	SATA Connector

CN1, CN2	SIM Card Socket
SPK_L1	Speaker out Connector for Left Side
SPK_R1	Speaker out Connector for Right Side
SW1	Super CAP Switch
SW2	COM1~4 with Power Select
USB2_1	USB 2.0 Connector
USB3_1, USB3_2, USB3_3	USB 3.2 GEN2 Connector
VGA1	VGA Connector (DB15)

## 2.3 Definition of Switches

### AT\_ATX1: AT / ATX Power Mode Switch

Switch	Definition
Left	AT Power Mode
Right	ATX Power Mode (Default)

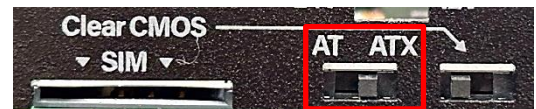

### RTC1: Clear CMOS Switch

Switch	Definition
Left	Normal (Default)
Right	Clear CMOS

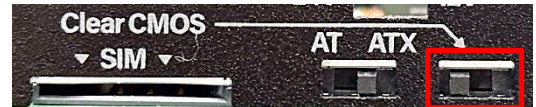

### BL\_PWR1: Backlight Power on / off

Switch	Definition
Push	Backlight Power on / off switching

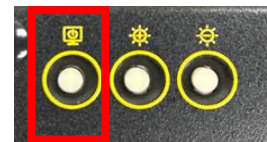

### BL\_UP1: Backlight Increase

Switch	Definition
Push	Backlight Increase

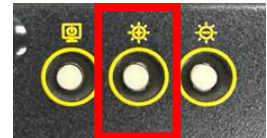

### BL\_DN1: Backlight Decrease

Switch	Definition
Push	Backlight Decrease

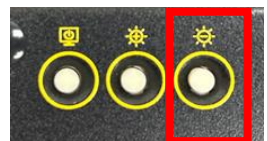



**LED1: HDD / Power Access LED Status**

Switch	Definition	LED Color
HDD LED	HDD Read/Write	Yellow
	No Operation	Colorless
POWER LED	POWER ON	Green
	POWER OFF	Colorless
	Stand by	Blinking Green



**PWR\_SW1: Power Button with Power on LED**

Switch	Definition
Push	Power System



**RESET1: Reset Button**

Switch	Definition
Push	Reset System



**SW2: COM1~4 with Power Select Switch**

Location	Function	DIP1	DIP2
SW2	COM1	0V(RI)	ON (Default)
		5V	ON
		12V	OFF

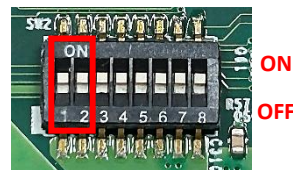

Location	Function	DIP3	DIP4
SW2	COM2	0V(RI)	ON (Default)
		5V	ON
		12V	OFF

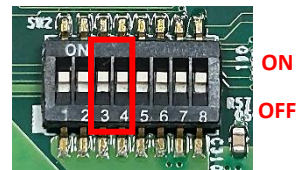

Location	Function	DIP5	DIP6
SW2	COM3	0V(RI)	ON (Default)
		5V	ON
		12V	OFF

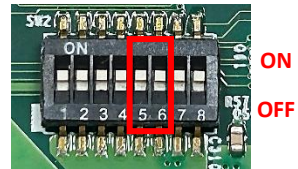

Location	Function	DIP7	DIP8
SW2	COM4	0V(RI)	ON (Default)
		5V	ON
		12V	OFF

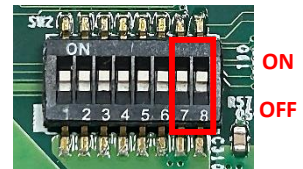

## SW1: Super CAP Switch

Location	Function	DIP1	DIP2
SW1	Super CAP Enabled	ON (Default)	ON (Default)
	Super CAP Disabled	OFF	



## 2.4 Definition of Connectors

### COM1 / COM2 / COM3/ COM4: RS232 / RS422 / RS485 Connector

Connector Type: 9-pin D-Sub

Pin	RS232 Definition	RS422 / 485 Full Duplex Definition	RS485 Half Duplex Definition
1	DCD	TX-	DATA -
2	RXD	TX+	DATA +
3	TXD	RX+	
4	DTR	RX-	
5	GND		
6	DSR		
7	RTS		
8	CTS		
9	RI		



### LAN LED Status Definition

Link LED Status	Definition
Steady Green	1 Gbps Network Link
Steady Orange	100 Mbps Network Link
Off	10 Mbps Network Link
Act LED Status	Definition
Blinking Yellow	Data Activity
Steady Yellow	No Activity

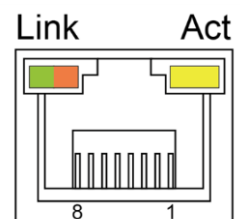

### DC\_IN1: 3 PINs DC 9-48V power input with power ignition connector

Connector Type: Terminal Block 1x3 3-pin, 5.0mm pitch

Pin	Definition
1	+9-48VIN
2	Ignition (IGN)
3	GND

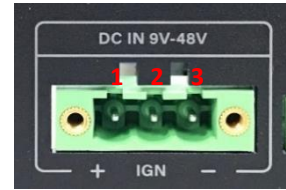

CAUTION  
(ATTENTION)

Please disconnect the power source before mounting the DC power cables or connecting the DC power connector to system.

(Veuillez débrancher la source d'alimentation avant de monter les câbles d'alimentation CC ou de connecter le connecteur d'alimentation CC au système.)

### POWER1 / POWER2: Power Connector, Support +5V/+12V

Connector Type: 1X4-pin Wafer, 2.0 mm pitch

Pin	Definition
1	+5V
2	GND
3	GND
4	+12V

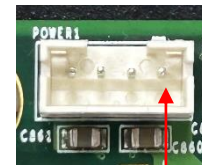

Pin 1

### PWR\_SW2: Remote Power on/off Connector

Connector Type: Terminal Block 1X2 2-pin, 3.5mm pitch

Pin	Definition
1	RMT_PWR_BTN_N
2	GND

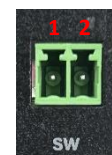

WARNING  
(AVERTIR)

Do not apply power to this connector! This port is used to connect a SWITCH!

(Ne mettez pas sous tension ce connecteur! Ce port est utilisé pour connecter un SWITCH!)

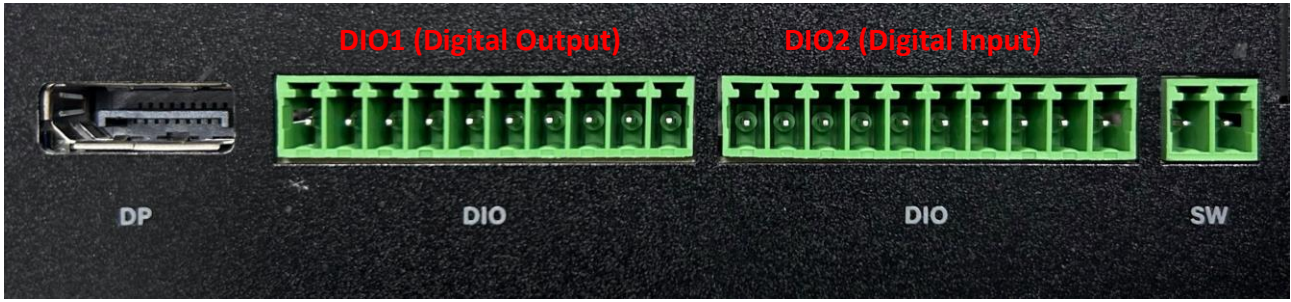

### DIO1: Digital Output Connector

Connector Type: Terminal Block 1X10 10-pin, 3.5mm pitch

Pin	Definition	Pin	Definition
1	XCOM+(DC INPUT)	6	DO5
2	DO1	7	DO6
3	DO2	8	DO7
4	DO3	9	DO8
5	DO4	10	XCOM-(GND)

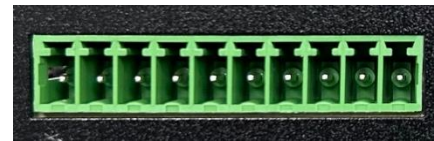

1

10

### DIO2: Digital Input Connector

Connector Type: Terminal Block 1X10 10-pin, 3.5mm pitch

Pin	Definition	Pin	Definition
1	XCOM+(DC INPUT)	16	DI5
2	DI1	17	DI6
3	DI2	18	DI7
4	DI3	19	DI8
5	DI4	20	XCOM-(GND)



1

10

**CN3 : Mini PCI-Express Socket (Support PCIE/ USB2.0 Interface)**

Pin No.	Pin Name	Pin No.	Pin Name
1	WAKE#	2	+3.3V
3	N/A	4	GND
5	N/A	6	+1.5V
7	CLKREQ#	8	N/A
9	GND	10	N/A
11	REFCLK-	12	N/A
13	REFCLK+	14	N/A
15	GND	16	N/A
<b>Mechanical KEY</b>			
17	N/A	18	GND
19	N/A	20	W_DISABLE1#
21	GND	22	PERST#
23	PERn	24	+3.3V
25	PERp	26	GND
27	GND	28	+1.5V
29	GND	30	SMB_CLK
31	PETn	32	SMB_DATA
33	PETp	34	GND
35	GND	36	USB_D-
37	GND	38	USB_D+
39	+3.3V	40	GND
41	+3.3V	42	N/A
43	GND	44	N/A
45	CLINK_CLK	46	N/A
47	CLINK_DAT	48	+1.5V
49	CLINK_RST	50	GND
51	N/A	52	+3.3V

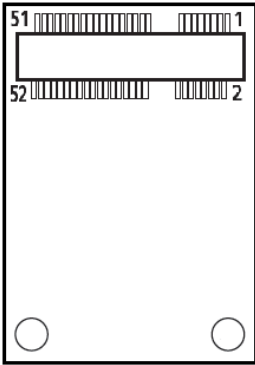

**CN5 : Mini PCI-Express Socket (Support PCIE/ USB3.0/ USB2.0 Interface)**

Pin No.	Pin Name	Pin No.	Pin Name
1	WAKE#	2	+3.3V
3	N/A	4	GND
5	N/A	6	+1.5V
7	CLKREQ#	8	UIM_PWR
9	GND	10	UIM_DATA
11	REFCLK-	12	UIM_CLK
13	REFCLK+	14	UIM_RST
15	GND	16	UIM_VPP
<b>Mechanical KEY</b>			
17	GND	18	PERST#
19	PERn/USB3_Rn	20	+3.3V
21	PERp/USB3_Rp	22	GND
23	GND	24	+1.5V
25	GND	26	SMB_CLK
27	PETn/USB3_Tn	28	SMB_DATA
29	PETp/USB3_Tp	30	GND
31	GND	32	USB_D-
33	GND	34	USB_D+
35	+3.3V	36	GND
37	+3.3V	38	N/A
39	GND	40	N/A
41	N/A	42	N/A
43	N/A	44	+1.5V
45	N/A	46	GND
47	N/A	48	+3.3V
49	GND	50	PERST#
51	PERn/USB3_Rn	52	+3.3V

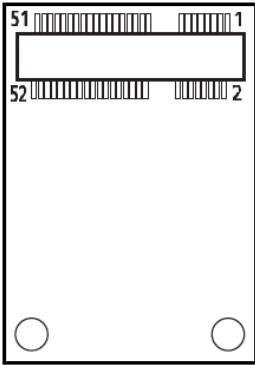

**CN4 : M.2 Key E Socket (Support PCIE / CNVi Module)**

Pin No.	Pin Name	Pin No.	Pin Name
1	GND	2	+3.3V
3	USB_D+	4	+3.3V
5	USB_D-	6	LED1#
7	GND	8	PCM_CLK
9	WGR_D1n	10	PCM_RSTN
11	WGR_D1p	12	PCM_IN
13	GND	14	PCM_OUT
15	WGR_D0n	16	LED2#
17	WGR_D0p	18	GND
19	GND	20	UART_WAKE#
21	WGR_CLKn	22	BRI_RSP
23	WGR_CLKp		
<b>Mechanical KEY</b>			
33	GND	32	RGI_DT
35	PETp0	34	RGI_RSP
37	PETn0	36	BRI_DT
39	GND	38	CLINK_RST
41	PERp0	40	CLINK_DATA
43	PERn0	42	CLINK_CLK
45	GND	44	COEX3
47	REFCLKp0	46	COEX_TXD
49	REFCLKn0	48	COEX_RXD
51	GND	50	SUSCLK
53	CLKREQ0#	52	PERST0#
55	PEWAKE0#	54	W_DISABLE2#
57	GND	56	W_DISABLE1#
59	WTD1n/PETp1	58	I2C_DATA
61	WTD1p/PETn1	60	I2C_CLK
63	GND	62	ALERT
65	WTD0n/PERp1	64	REFCLK
67	WTD0p/PERn1	66	PERST1#

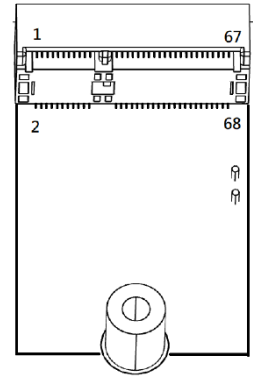

69	GND	68	CLKREQ1#
71	WTCLKn/REFCLKp1	70	PEWAKE1#
73	WTCLKp/REFCLKn1	72	+3.3V
75	GND	74	+3.3V

## 2.5 Optional Module Pin Definition & Settings

### 2.5.1 CFM-IGN101 Module

#### SW2 (on CFM-IGN101) : IGN Module Timing Setting Switch

Set shutdown delay timer when ACC is turned off

Pin 1	Pin 2	Pin 3	Pin 4	Definition
ON (IGN Enabled)	ON	ON	ON	0 second
	ON	ON	OFF	1 minute
	ON	OFF	ON	5 minutes
	ON	OFF	OFF	10 minutes
/	OFF	ON	ON	30 minutes
	OFF	ON	OFF	1 hour
	OFF	OFF	ON	2 hours
	OFF	OFF	OFF	Reserved (0 second)

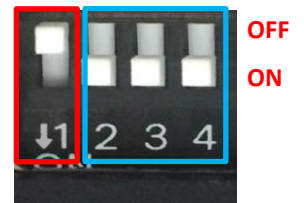

Default setting of Pin1 to Pin4 is OFF/ON/ON/ON.



#### 24V\_12V\_1 (on the system) : IGN Module Voltage Mode Setting Switch

##### 12V / 24V Car Battery Switch

Switch	Definition
Left	24V Car Battery Input (Default)
Right	12V Car Battery Input







# **Chapter 3**

## **System Setup**

This chapter uses P2202 as an example to illustrate the installation of hardware components, with the exception of Chapter 3.6 and 3.17 (which demonstrates the installation of P2202E).

### 3.1 Removing the Top Cover



**WARNING**  
**(AVERTIR)**

**In order to prevent electric shock or system damage, must turn off power and disconnect the unit from power source before removing the chassis cover.**

**(Afin d'éviter tout risque d'électrocution ou d'endommagement du système, vous devez couper l'alimentation et débrancher l'appareil de la source d'alimentation avant de retirer le couvercle du châssis.)**

Step 1. Loosen the eight screws at front and rear panel



Step 2. Raise the top cover and remove it from the chassis.



Step 3. Place the top cover aside gently.

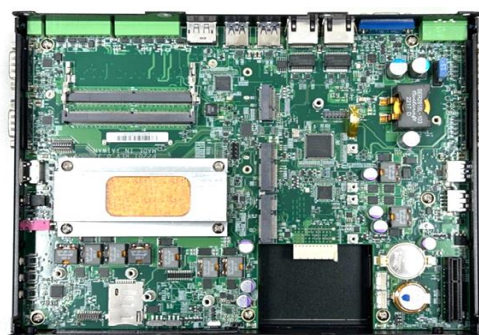
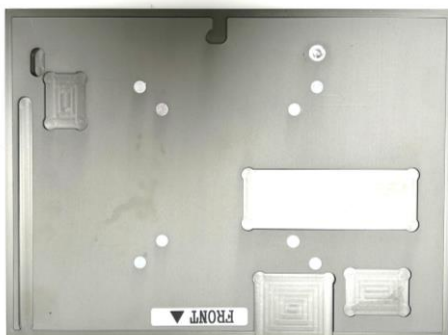

## 3.2 Installing Mini PCIe Card(s)

Step 1. Locate Mini PCIe sockets on the system board.

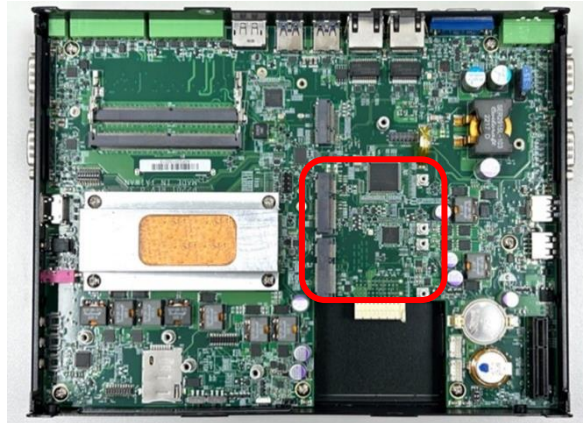

Step 2. Use provided two screws fasten the half size module and adapter bracket together as shown in Fig (a) below.



(a) Half Size Mini-PCIe Card

(b) Full Size Mini-PCIe Card

Step 3. Tilt the Mini PCIe card at a 45-degree angle and insert it into the socket until the golden finger connector of the card seated firmly.



Step 4. Press down the card and secure it with two screws.



### 3.3 Installing a M.2 E Key Card

Step 1. Locate the M.2 E Key socket on the system board.

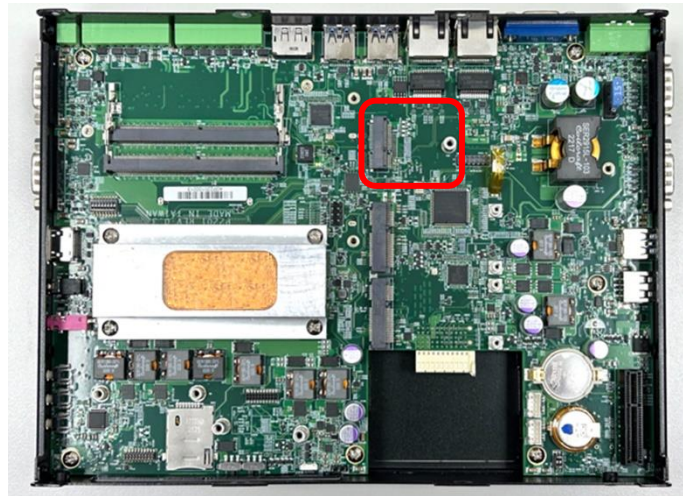

Step 2. Tilt the M.2 E Key card at a 45-degree angle and insert it to the socket until the golden finger connector of the card seated firmly.

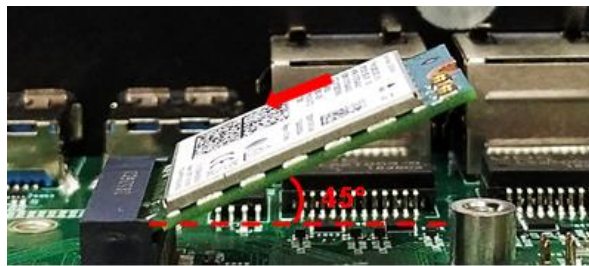

Step 3. Press the card down and secure it with 1 screw.



### 3.4 Installing Antenna(s)

Step 1. Remove the antenna rubber cover on either the front, left, or right panel of the system. (The front panel will be used for this example.)



Step 2. Penetrate the antenna jack through the hole. And then put on the washer and fasten the nut with antenna jack.

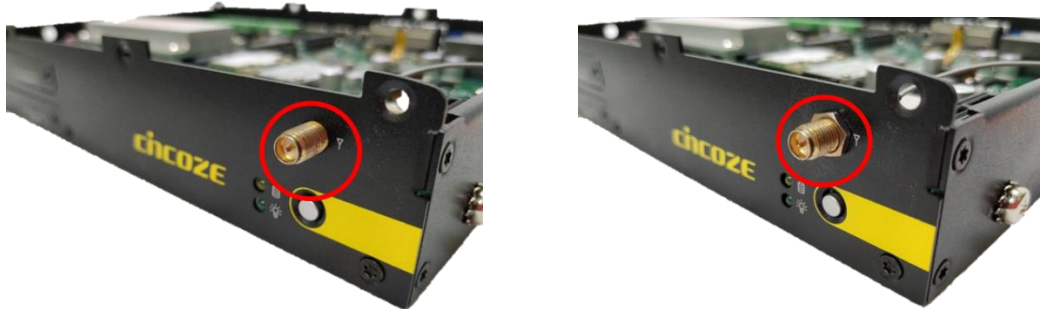

Step 3. Assemble the antenna and antenna jack together.



Step 4. Attach the RF connector at another end of the cable onto the card.

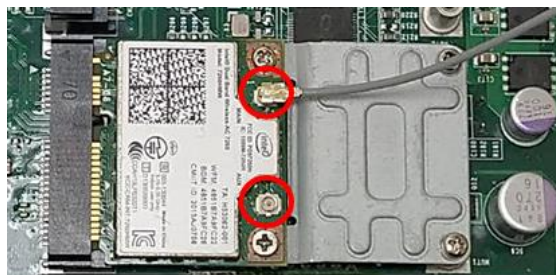

### 3.5 Installing SO-DIMM(s)

Step 1. Locate the SO-DIMM socket on the system board.

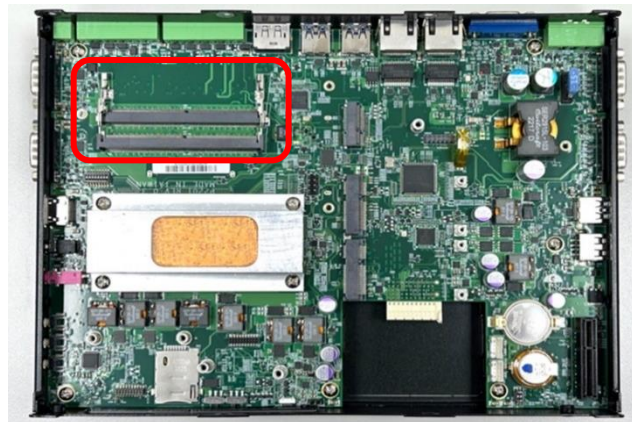

Step 2. Tilt the memory module at a 45-degree angle, and insert it into SO-DIMM socket until the golden finger connector of the module is seated firmly.



Step 3. Press down the memory module until retaining clips snap back in place.



Step 4. For the upper SO-DIMM socket, please follow the same steps described earlier to install.

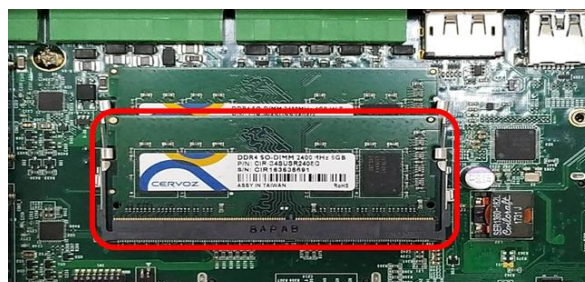

## 3.6 Installing a PCI(e) Card

This chapter takes P2202E for example to demonstrate the installation steps.

Step 1. Loosen the two screws as indicated at rear panel.



Step 2. Attach the PCI / PCIe Card Installation Kit on, and fasten the two screws back on rear panel to fix the Kit.



Step 3. Loosen the screw as indicated to remove the PCI bracket.



Step 4. Align the notch of golden fingers of Riser card (Optional) with the slot. Insert the card vertically, and press the card straight down into the slot until it's seated firmly.



Step 5. Align the notch of golden fingers of PCI(e) card with the expansion slot. Insert the card horizontally, and press the card straight down into the slot until it's seated firmly.



Step 6. Fasten the screw back to secure the PCI(e) expansion card.



Step 7. Loosen the two screws as indicated to have the clamp arm slidable.

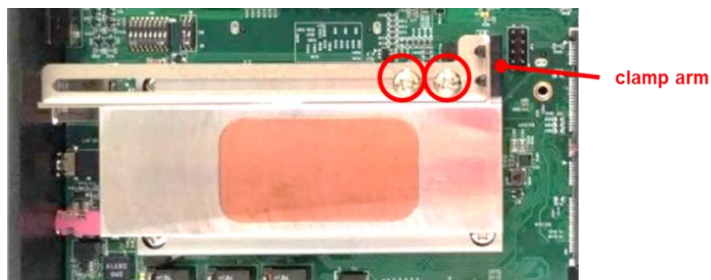

Step 8. Slide the clamp arm of retention module until it contacts the edge of PCI(e) expansion card.

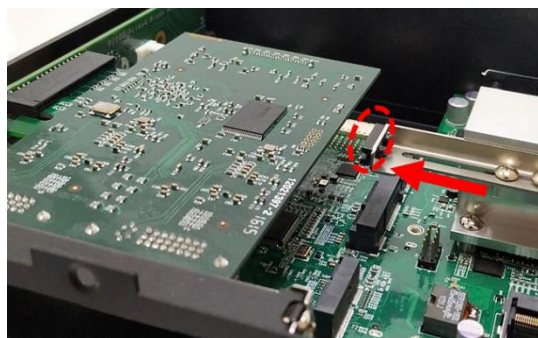



Step 9. Finally, fasten the two screws that were previously loosen halfway to fix the retention module.

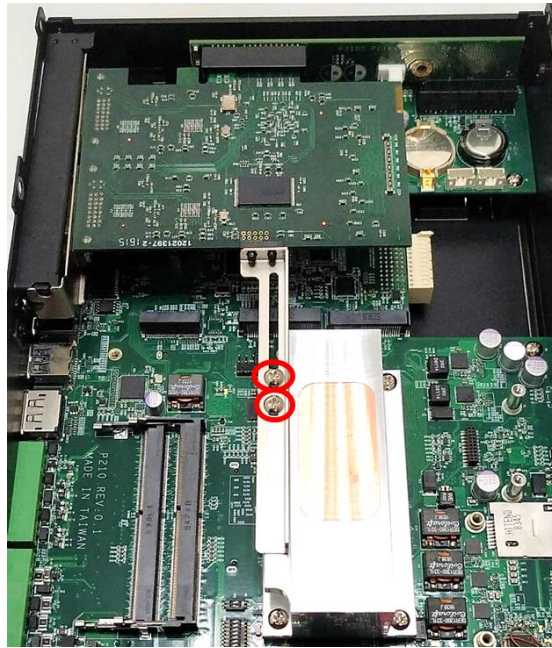

### 3.7 Installing Thermal Pad of Thermal Block

Step 1. Place thermal pad on the top of CPU thermal block in order to provide a seamless contact with the body of chassis to create an efficient heat dissipation.

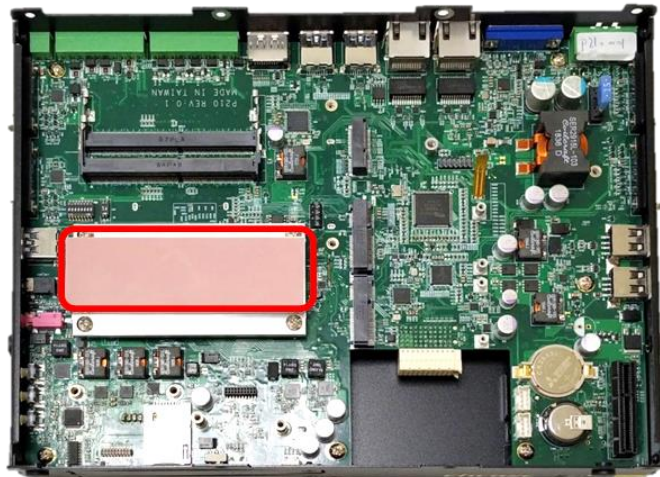

**CAUTION  
(ATTENTION)**

**Before assembling the system's chassis cover, please make sure the protective film on the Thermal Pad has been removed!**

**(Avant d'assembler le capot du châssis du système, assurez-vous que le film protecteur du coussin thermique a été retiré !)**

### 3.8 Installing the Top Cover

Step 1. Put on the edge of top cover onto system, and the other side subsequently.



Step 2. Fasten the eight screws at front and rear panel to secure the top cover.



### 3.9 Disassemble the CO Display Module

The complete shipping product is the CO display module already installed on the P2202. This chapter will introduce how to disassemble CO display module and P2202.

Step 1. Remove the 6 screws on the display module.

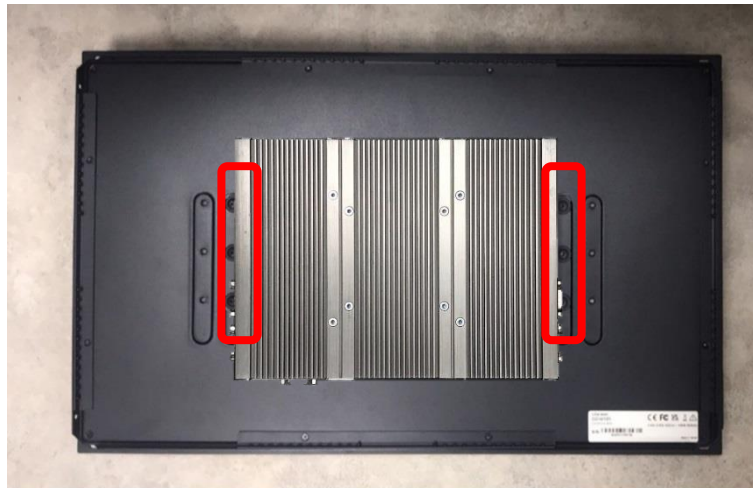

Step 2. Disconnect the modules.



### 3.10 Installing a SATA Hard Drive at Front Panel

Step 1. Loosen the screw to remove the HDD bay cover bracket.



Step 2. Loosen the screw as indicated on the HDD bracket.



Step 3. Pull the rotating arm of HDD bracket outward as indicated.



Step 4. Hold the rotating arm to pull out the HDD bracket.



Step 5. Place the HDD bracket on screw-hole side of HDD. Use four screws provided to assemble HDD on the bracket.



Step 6. Align the HDD bracket with the entrance of HDD bay. And insert the HDD bracket and push it until the edge connector of HDD fully inserted into SATA slot.



Step 7. Fasten the screw as indicated on the HDD bracket.



Step 8. Put back HDD bay cover at front panel, and fasten it with the screw.



### 3.11 Installing a SATA hard drive on Bottom Side

Step 1. Turn over the system to bottom side. Locate the cover of HDD compartment.

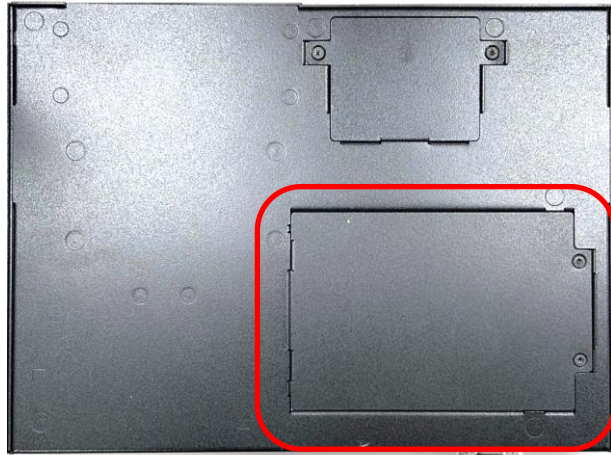

Step 2. Loosen the two screws, lift the cover, and then remove it.

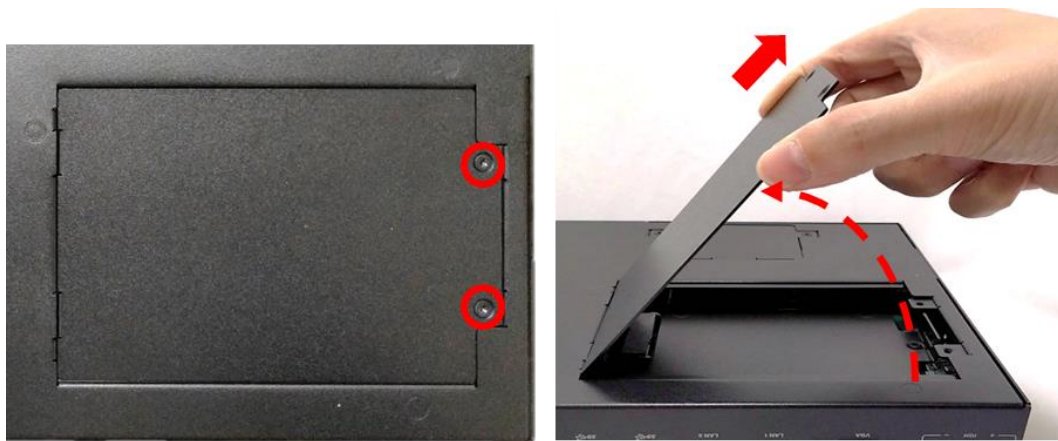

Step 3. Loosen three screws and take the HDD bracket out of HDD compartment.

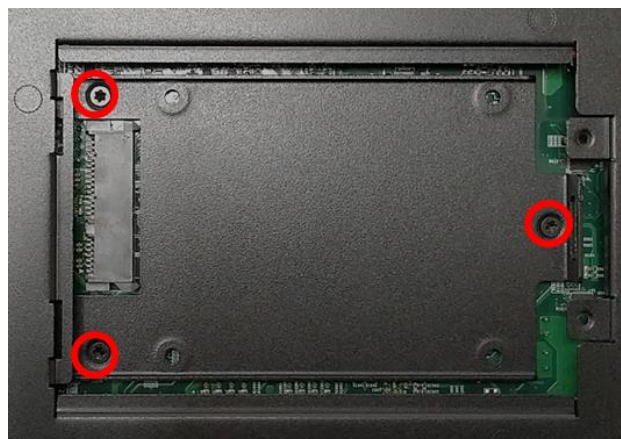

Step 4. Place the HDD bracket on screw-hole side of HDD. Use four screws provided to assemble HDD on the bracket.

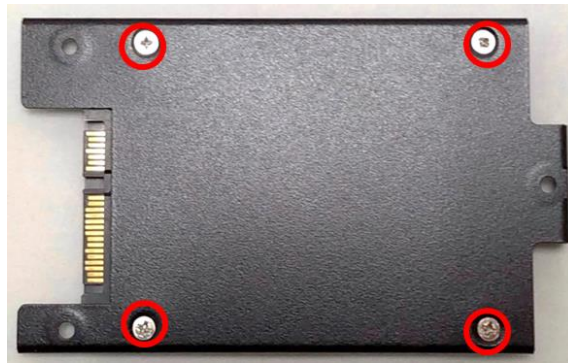

Step 5. Seat the HDD bracket into HDD compartment, and line up the connector of HDD with SATA slot, then push it until HDD is fully connected into slot.



Step 6. Secure the HDD bracket with three screws.



Step 7. Put back the cover and fasten the two screws.



## 3.12 Installing a SIM Card

Step 1. Loosen the screw to remove the Maintenance cover bracket.

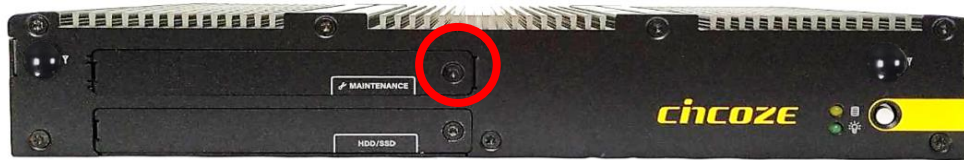

Step 2. Locate the SIM card slot.



Step 3. Insert the SIM card.





## 3.13 Installing CFM Modules

### 3.13.1 CFM-IGN101 Module

Step 1. Locate the power Ignition connector on system motherboard as indicated.

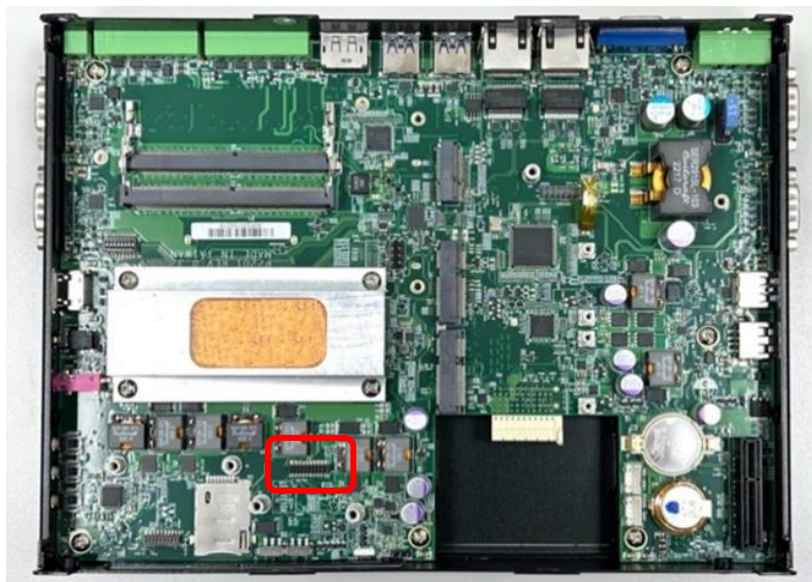

Step 2. Insert the female connector of power ignition board to the male connector on system motherboard.

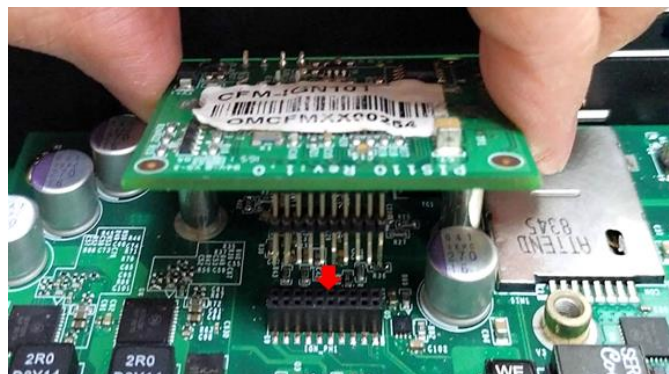

Step 3. Fasten two screws to secure the power ignition board.



### 3.13.2 CFM-PoE04 Module

Step 1. Place a thermal pad on the top of the heatsink, and locate the two regions as marked.



Step 2. Turn over the heatsink and paste the thermal pad at the marked region.



**CAUTION**  
(ATTENTION)

Before putting on the thermal block, please make sure the protective film on the Thermal Pad has been removed!

(Avant de mettre le bloc thermique, veuillez vous assurer que le film protecteur sur le coussin thermique a été retiré!)

Step 3. Paste the thermal pad onto the coil of the CFM-PoE module.

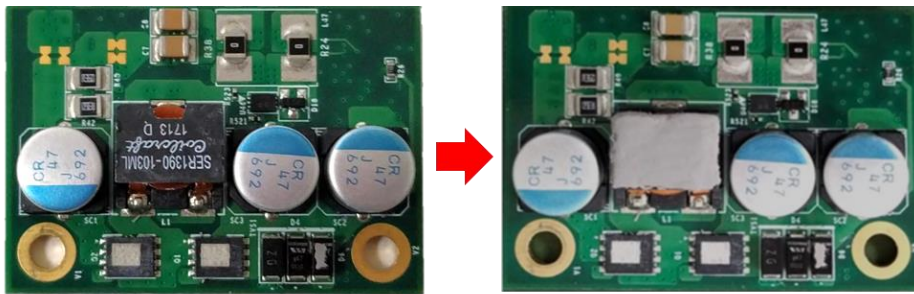

Step 4. Locate the PoE connector on system motherboard as indicated.

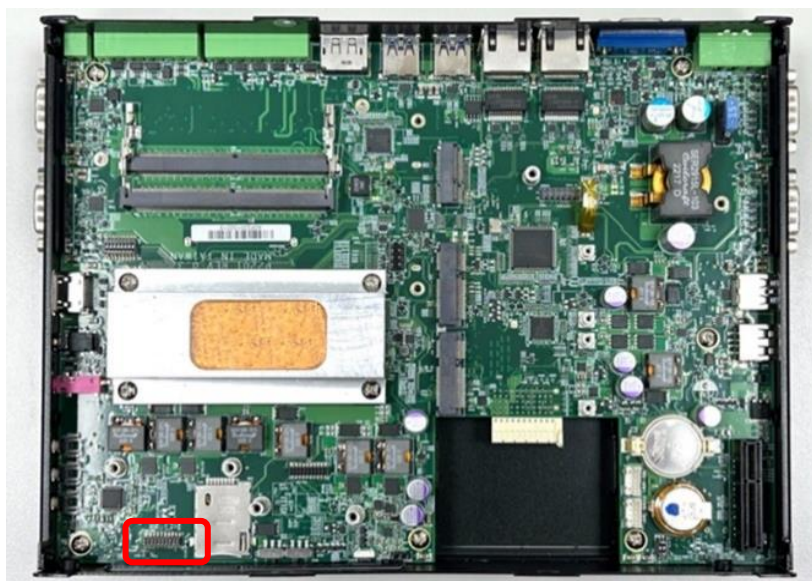

Step 5. Insert the female connector of PoE daughter board to the male connector on system motherboard.

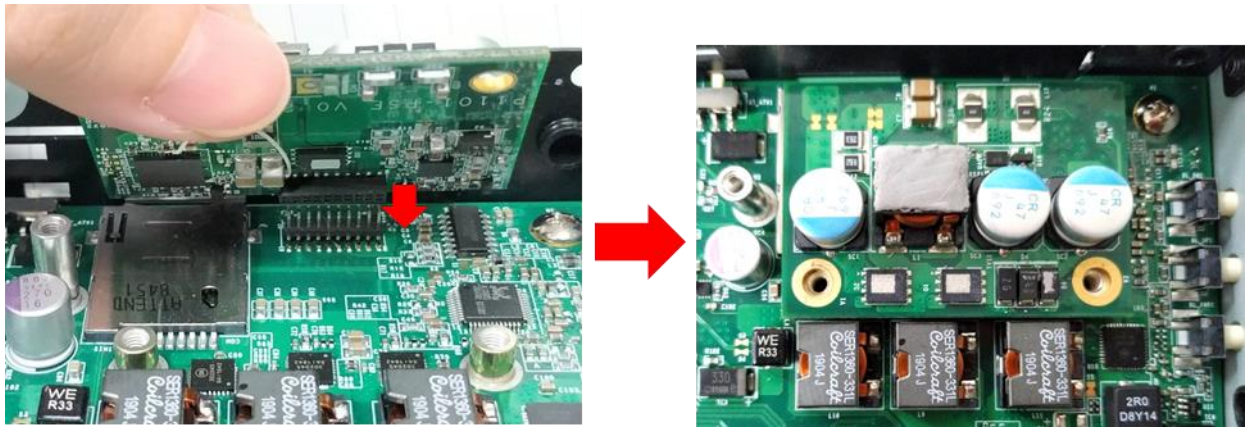

Step 6. Put on the PoE thermal block and fasten two screws to secure the PoE board.

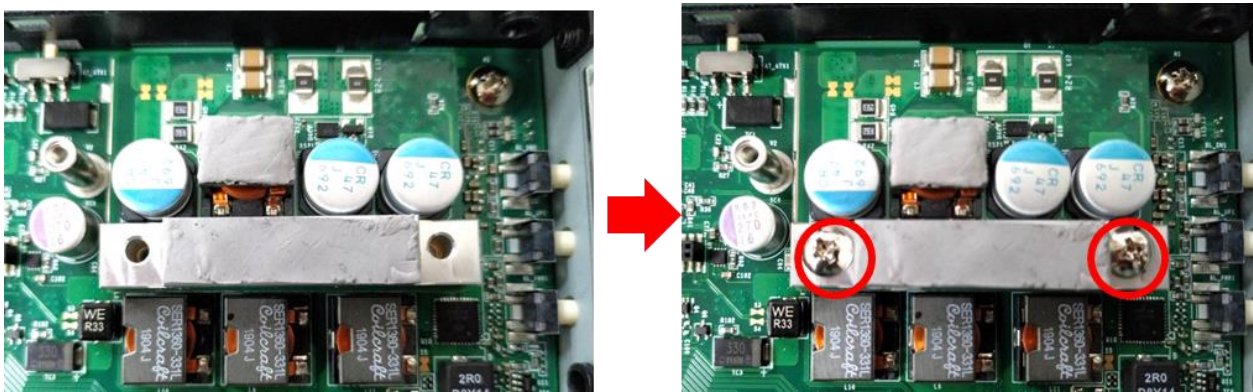

**CAUTION**  
**(ATTENTION)**

**Before assembling the system's chassis cover, please make sure the protective films on the Thermal Pads have been removed!**  
**(Avant d'assembler le capot du châssis du système, assurez-vous que les films de protection sur les coussinets thermiques ont été retirés !)**

## 3.14 Installing MEC Modules

This chapter takes P2202E for example to demonstrate the installation steps.

### 3.14.1 MEC-COM-M212-TDB9/UB1203 Module

Step 1. Loosen 2 screws on the cover plate of number 1 or 2 and then remove it. In the following steps, we use cover plate 1 for example. (You can install two MEC-USB modules for system P2202E. We only use one MEC-USB module for the example.)



Step 2. Locate one of the Mini PCIe sockets on the bottom side of the system.

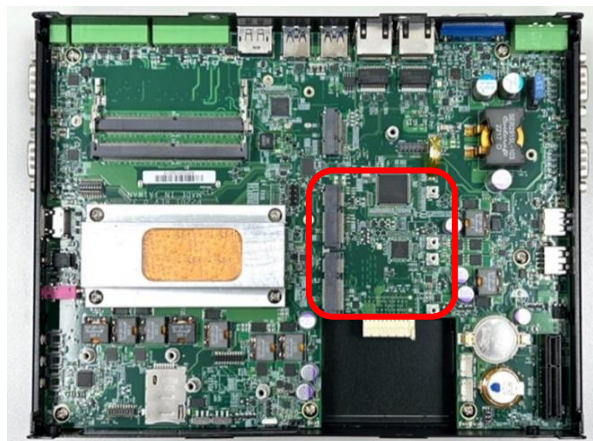

Step 3. Tilt the Mini PCIe card at a 45-degree angle and insert it to the socket until the golden finger connector of the card seated firmly.



Step 4. Press the card down and secure it with 2 screws.

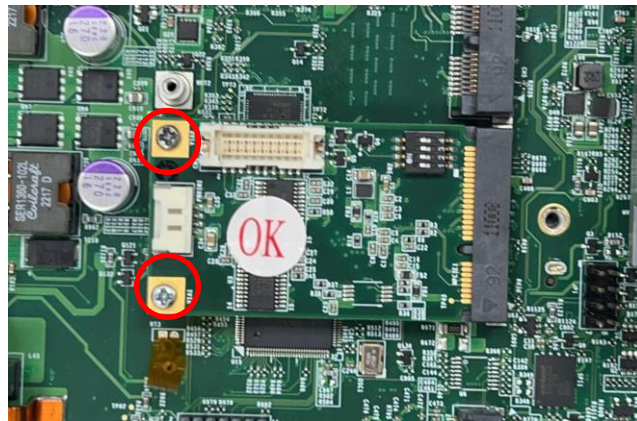

Step 5. Remove the 4 D-Sub jack screws from the COM ports.

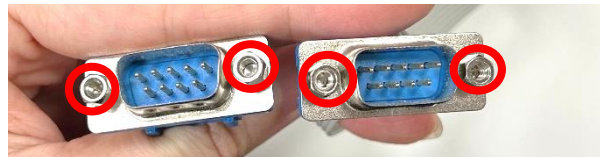

Step 6. Connect the other end of the wire to the Mini PCIe card as indicated.

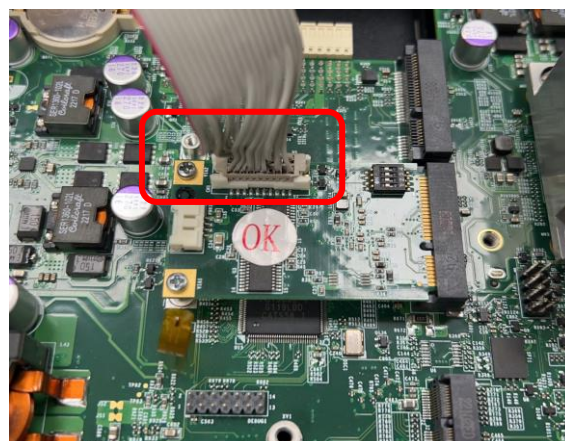

Step 7. Attach the COM ports onto the back side of the cover plates, and then fasten the 4 D-Sub jack screws to secure the COM ports.

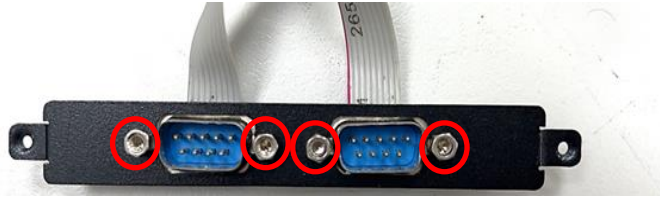

Step 8. Attach the MEC-COM bracket, and fasten the 2 screws to fix it as indicated.



### 3.14.2 MEC-COM-M334-TDB9/UB1203 Module

Step 1. Loosen 2 screws on the cover plate of number 1 or 2 and then remove it. In the following steps, we use cover plate 1 for example. (You can install two MEC-USB modules for system P2202E)



Step 2. Locate one of the Mini PCIe sockets on the bottom side of the system.

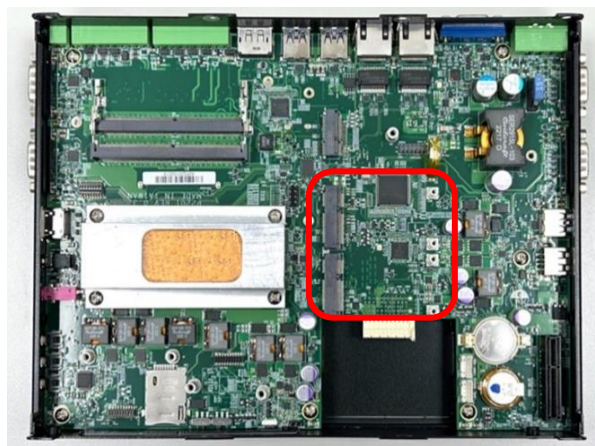

Step 3. Tilt the Mini PCIe card at a 45-degree angle and insert it to the socket until the golden finger connector of the card seated firmly.

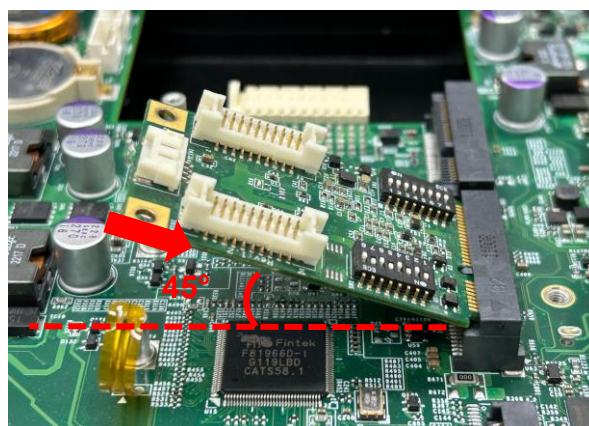

Step 4. Press the card down and secure it with 2 screws.

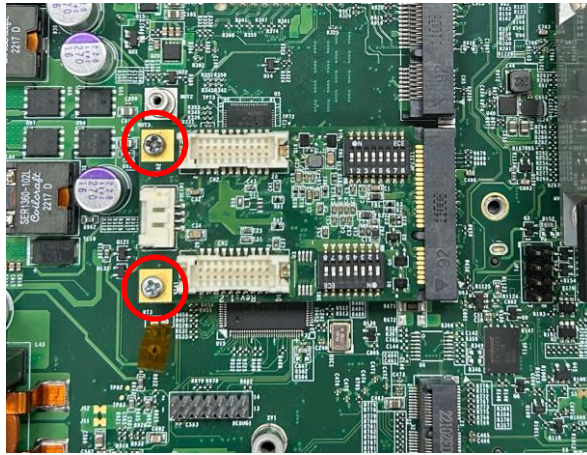

Step 5. Remove the 8 D-Sub jack screws from the COM ports.

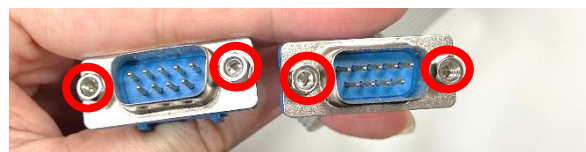
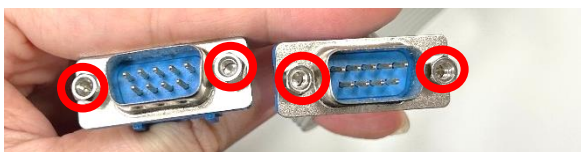
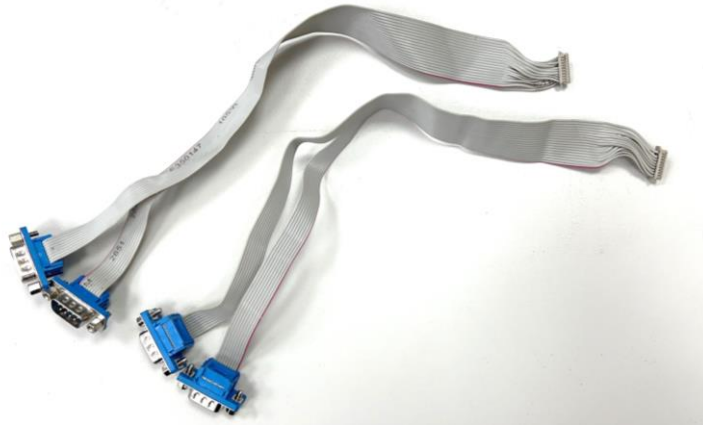



Step 6. Connect the other end of the wire to the Mini PCIe card as indicated.

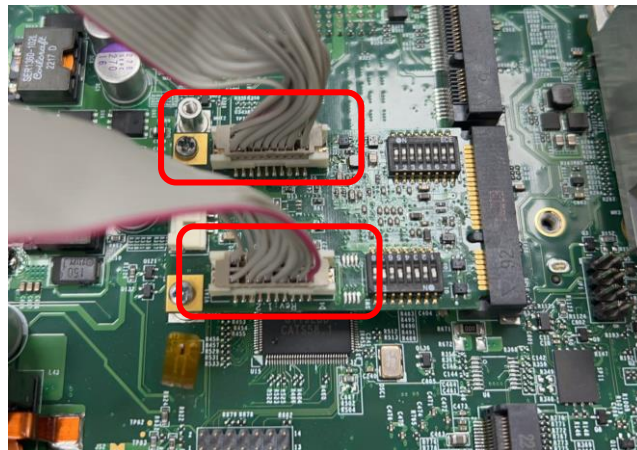

Step 7. Attach the COM ports onto the back side of the cover plates, and then fasten the 8 D-Sub jack screws to secure the COM ports.



Step 8. Attach the MEC-COM bracket, and fasten the 4 screws to fix it as indicated.



### 3.14.3 MEC-USB-M102-30/UB1214 Module

Step 1. Loosen 2 screws on the cover plate of number 1 or 2 and then remove it. In the following steps, we use cover plate 1 for example. (You can install two MEC-USB modules for system P2202E)



Step 2. Locate one of the Mini PCIe sockets on the bottom side of the system.

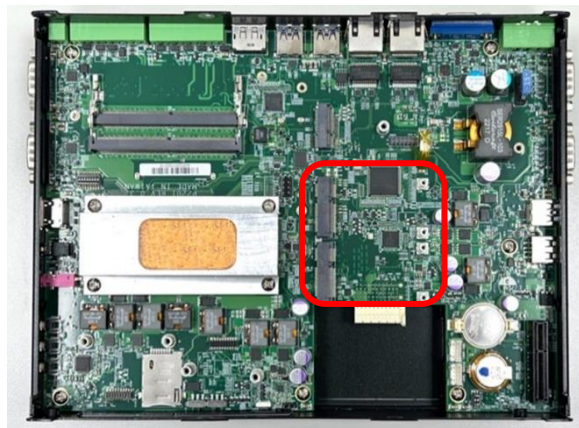

Step 3. Tilt the Mini PCIe card at a 45-degree angle and insert it to the socket until the golden finger connector of the card seated firmly.

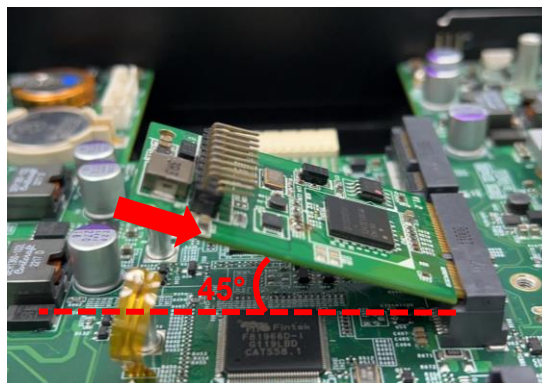

Step 4. Press the card down and secure it with 2 screws.

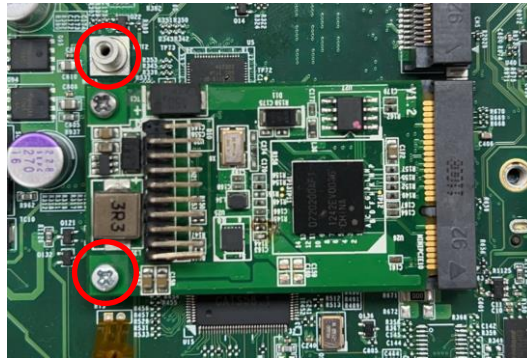

Step 5. Connect the attached wire to the USB board.



Step 6. Connect the other end of the wire to the Mini PCIe card as indicated.



Step 7. Attach the USB board onto the back side of the cover plate, and then fasten the two screws to secure the module.

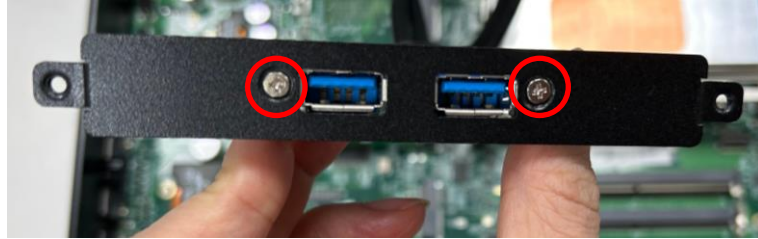

Step 8. Attach the MEC-USB bracket, and fasten the 2 screws to fix it as indicated.



### 3.14.4 MEC-LAN-M102-30/UB1211 Module

Step 1. Loosen 2 screws on the cover plate of number 1 or 2 and then remove it. In the following steps, we use cover plate 1 for example. (You can install two MEC-LAN modules for system P2202E)



Step 2. Locate one of the Mini PCIe sockets on the bottom side of the system.

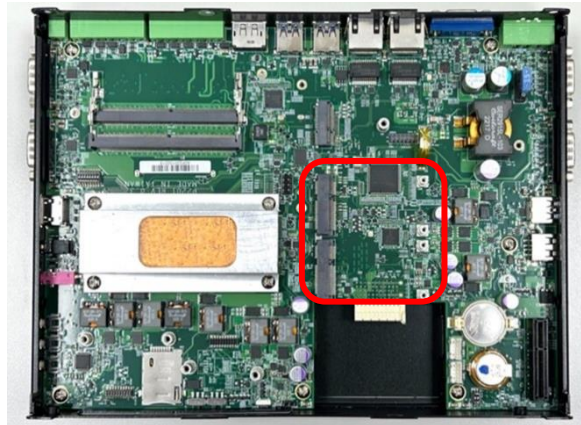

Step 3. Tilt the Mini PCIe card at a 45-degree angle and insert it to the socket until the golden finger connector of the card seated firmly.

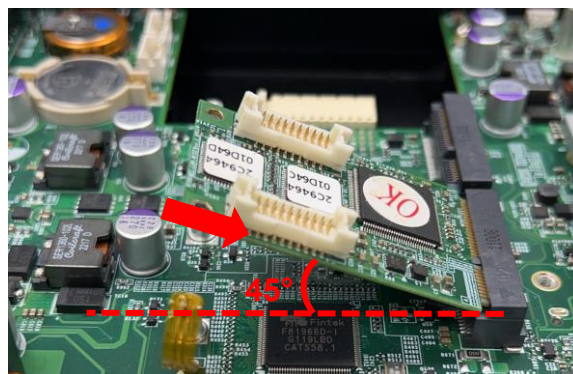

Step 4. Press the card down and secure it with 2 screws.

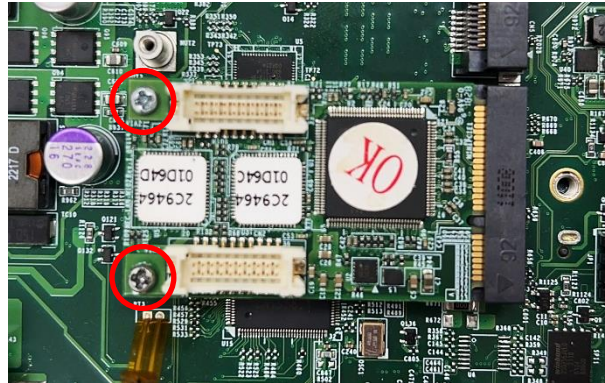

Step 5. Connect the attached wires to the LAN board.



Step 6. Connect the wires to the Mini PCIe card as indicated.

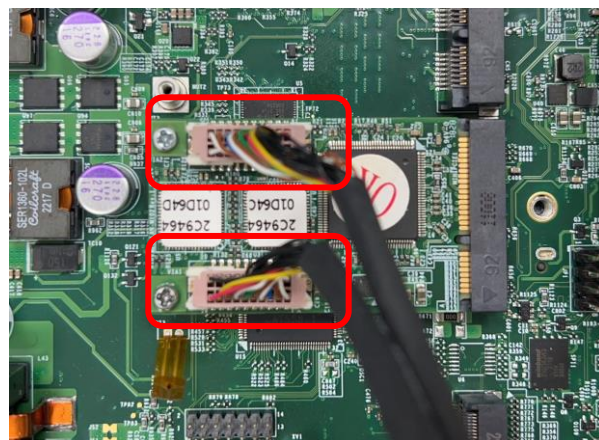

Step 7. Attach the LAN board onto the back side of the cover plate, and then fasten the two screws to secure the module.



Step 9. Attach the MEC-LAN bracket, and fasten the 2 screws to fix it as indicated.



### 3.15 Installing Standard Mount

The CO-100 series currently features two types of Mounting Bracket designs. For example, the Mounting Bracket designs of CO-W121C and CO-119C as illustrated below.



CO-W121C



CO-119C

CO-119C is essentially identical to CO-W121C in terms of installation, with the only difference being the design of the Mounting Bracket. The following steps will demonstrate the installation using CO-W121C as an example.

Before doing the following steps, please make sure the screw positions are fastened at the default positions as indicated in the following picture. The default positions are the correct positions for Standard Mount, so it does not need to change the screw positions additionally for Standard Mount.





Step 1. Put the CO-100/P2202 module onto the rack's back side.



There are two methods for fastening the CO-100/P2202 module onto the cabinet to complete the flat mount. One is to fix the CO-100/P2202 module from the front side of the cabinet, which is illustrated in chapter 3.15.1. The other one is to fix the CO-100/P2202 module from the rear side of the cabinet, which is illustrated in chapter 3.15.2.

### 3.15.1 Fixing from front side

Step 2. Fasten the screws from the cabinet's front side. Please prepare 12 pcs of M4 screws for fixing the module through the circle holes (with screw thread).

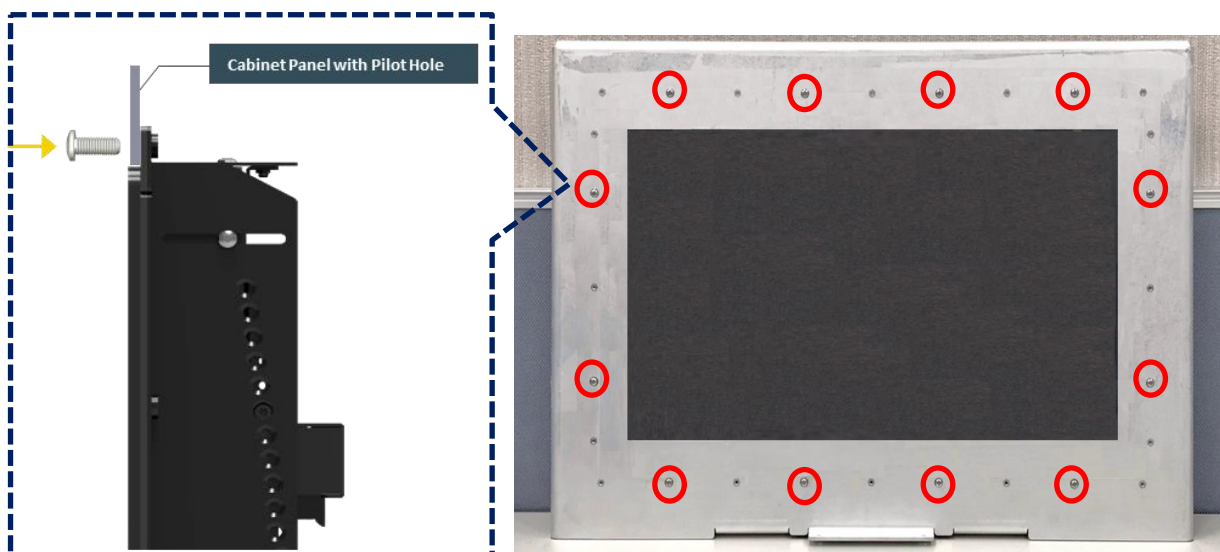

### 3.15.2 Fixing from rear side

Step 2. If the cabinet panel is with stud bolts as the following figure, user can prepare 16 pcs of nuts for fixing the module through the **oblong holes** (oblong hole size: 9mmx4mm, without screw thread)

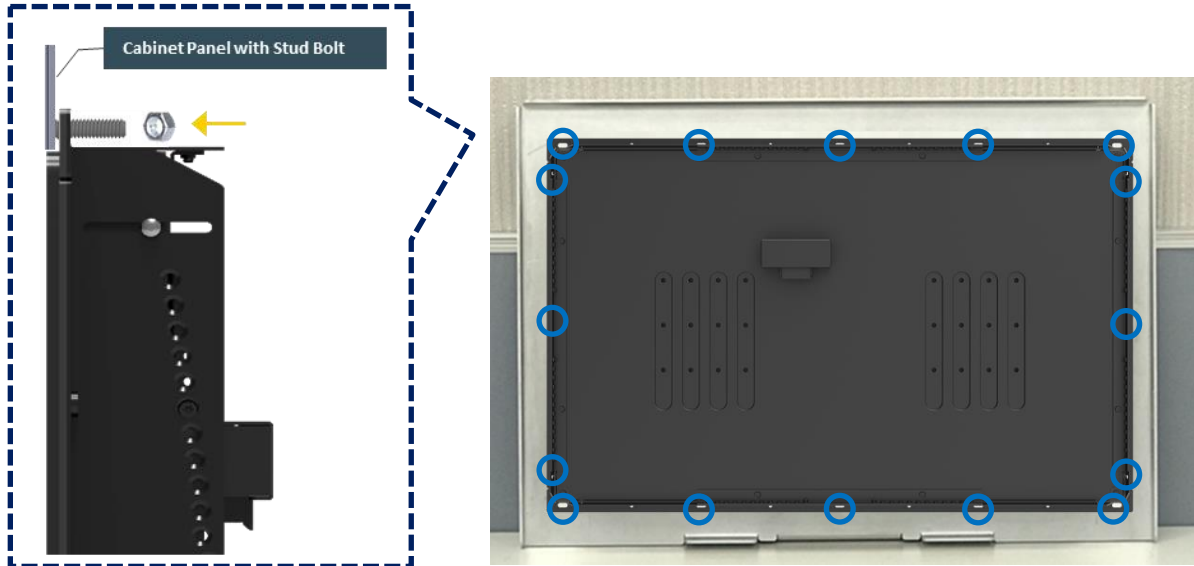

If the cabinet panel is with bosses as the following figures, user can prepare 16 pcs of M4 screws for fixing the module through the **oblong holes** (oblong hole size: 9mmx 4mm, without screw thread).

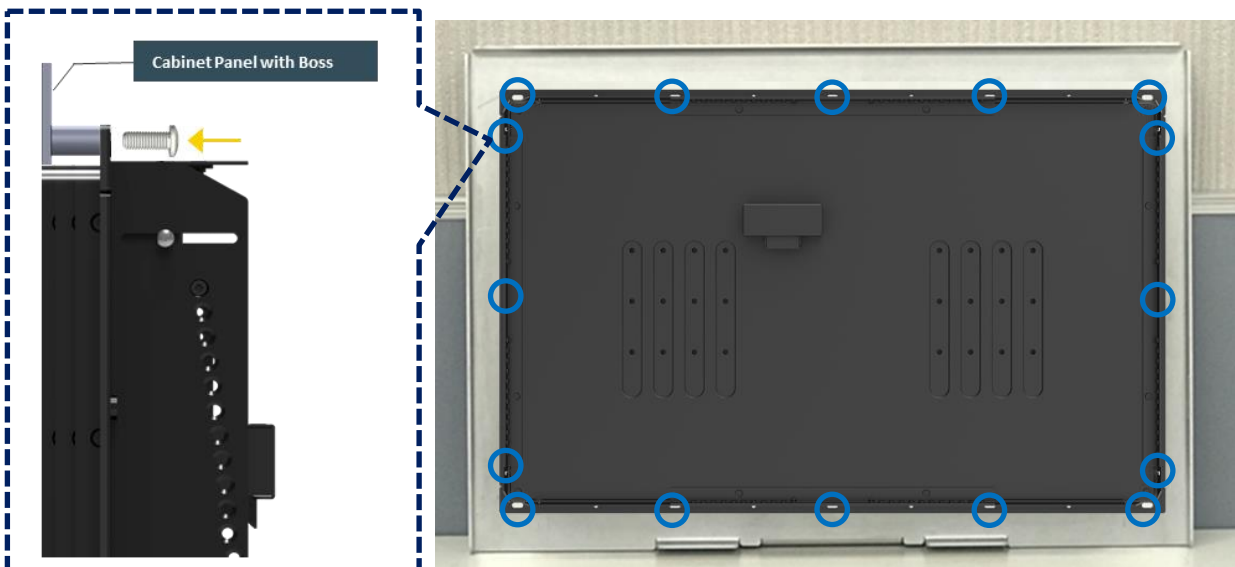



### 3.16 Installing Flat Mount

The CO-100 series currently features two types of Mounting Bracket designs. For example, the Mounting Bracket designs of CO-W121C and CO-119C as illustrated below.



CO-W121C



CO-119C

CO-119C is essentially identical to CO-W121C in terms of installation, with the only difference being the design of the Mounting Bracket. The following steps will demonstrate the installation using CO-W121C as an example.

Step 1. Locate the left and right-side mounting brackets.

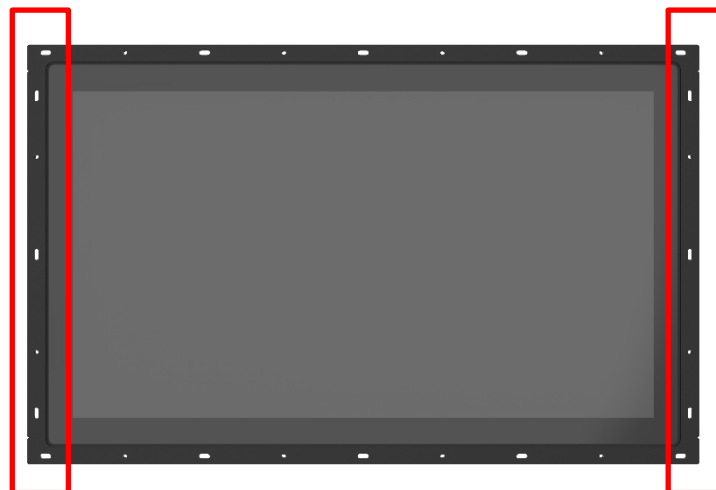

Step 2. Remove the two screws on the left and right-side mounting brackets.

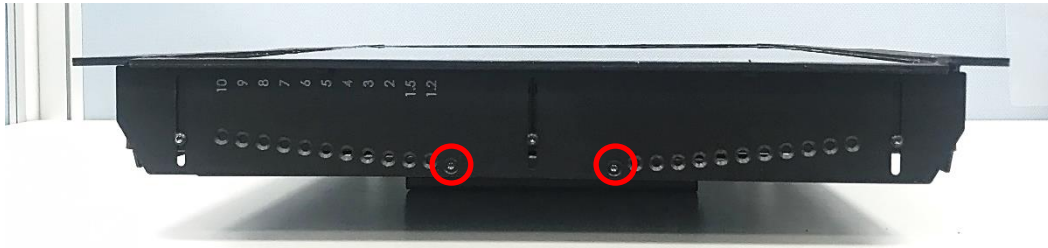

Step 3. Loosen the three screws on the left and right-side mounting brackets.



Step 4. Measure the rack thickness. The thickness is measured 3mm in this example.

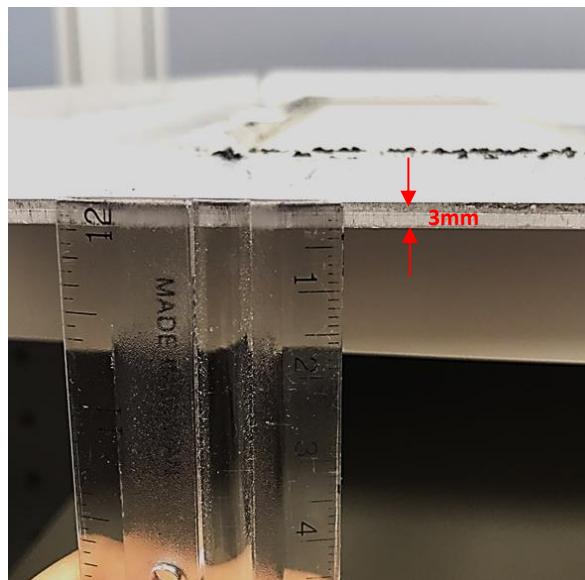

Step 5. According to the thickness = 3mm for the example, push down the left and right-side mounting brackets to the place at screw hole = 3mm.



Step 6. Fasten the two screws on the left and right-side mounting brackets.



Step 7. Fasten the three screws on the left and right-side mounting brackets.



Step 8. Locate the top and bottom-side mounting brackets.

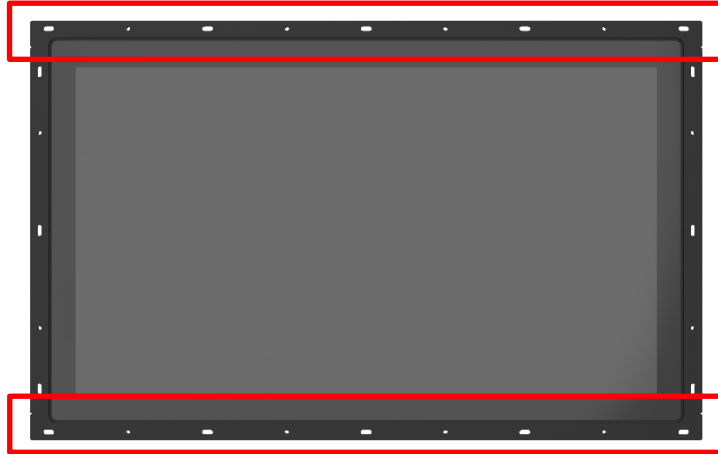

Step 9. Remove the two screws on the top and bottom-side mounting brackets.

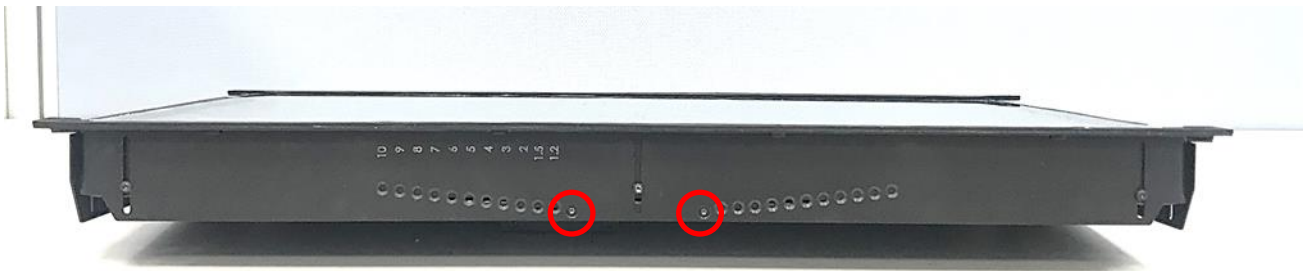

Step 10. Loosen the three screws on the top and bottom-side mounting brackets.



Step 11. According to the thickness = 3mm for the example, push down the top and bottom-side mounting brackets to the place at screw hole = 3mm.

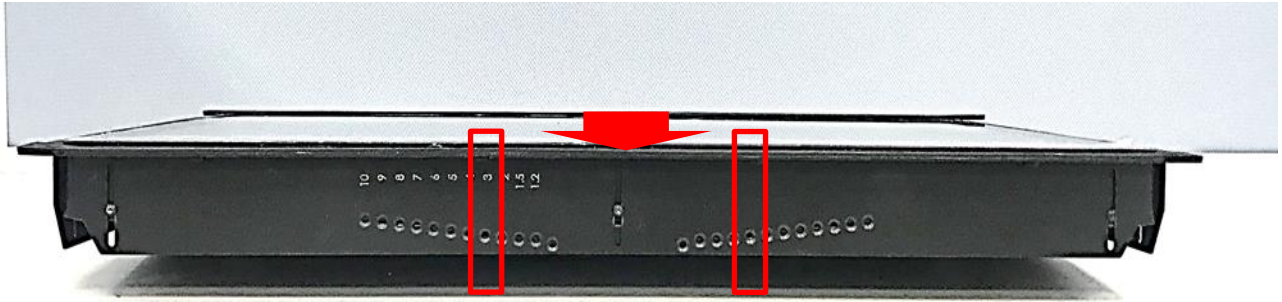

Step 12. Fasten the two screws on the top and bottom-side mounting brackets.

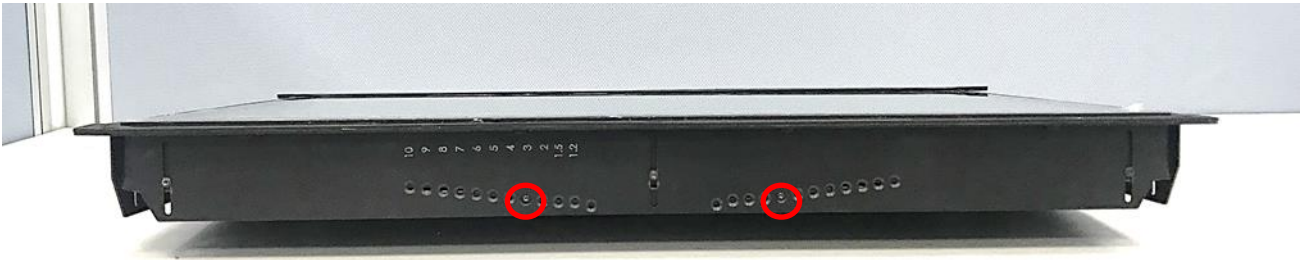

Step 13. Fasten the three screws on the top and bottom-side mounting brackets.





Step 14. Put the CO-100/P2202 module onto the rack back side.



There are two methods for fastening the CO-100/P2202 module onto the cabinet to complete the flat mount. One is to fix the CO-100/P2202 module from the front side of the cabinet, which is illustrated in chapter 3.16.1. The other one is to fix the CO-100/P2202 module from the rear side of the cabinet, which is illustrated in chapter 3.16.2.

### 3.16.1 Fixing from front side

Step 15. Fasten the screws from the cabinet's front side. Please prepare 12 pcs of M4 screws for fixing the module through the circle holes (with screw thread).

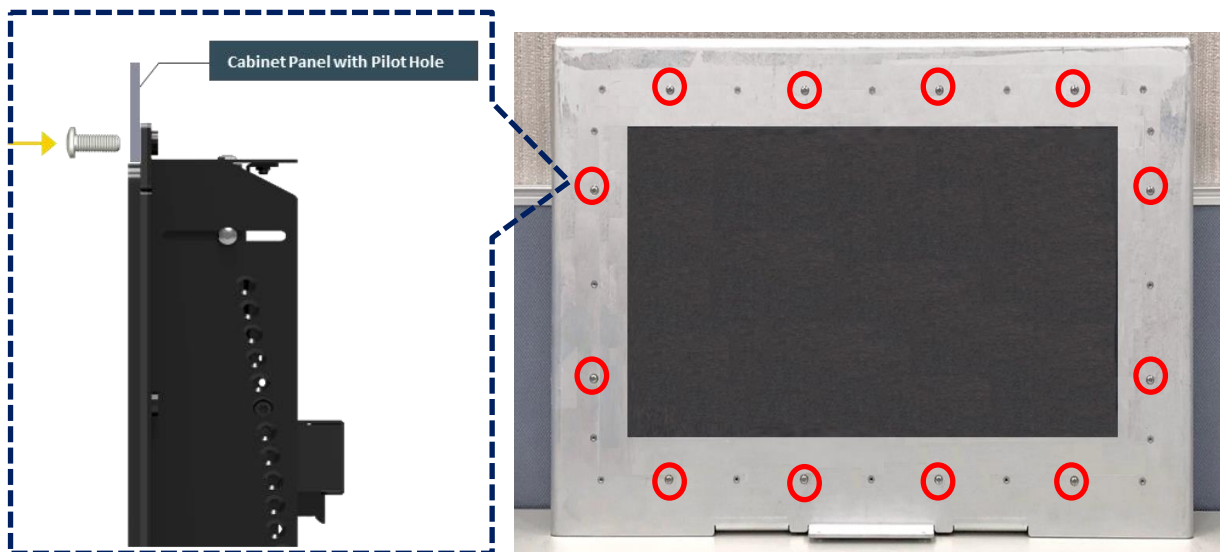

### 3.16.2 Fixing from rear side

Step 15. If the cabinet panel is with stud bolts as the following figure, user can prepare 16 pcs of nuts for fixing the module through the **oblong holes** (oblong hole size: 9mmx4mm, without screw thread)

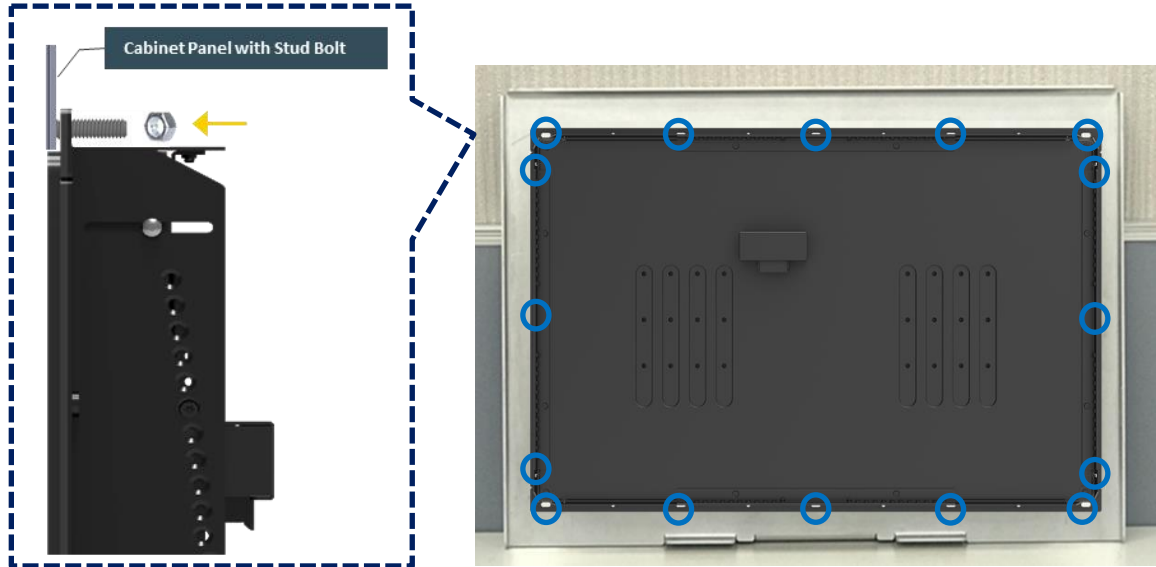

If the cabinet panel is with bosses as the following figures, user can prepare 16 pcs of M4 screws for fixing the module through the **oblong holes** (oblong hole size: 9mmx 4mm, without screw thread).

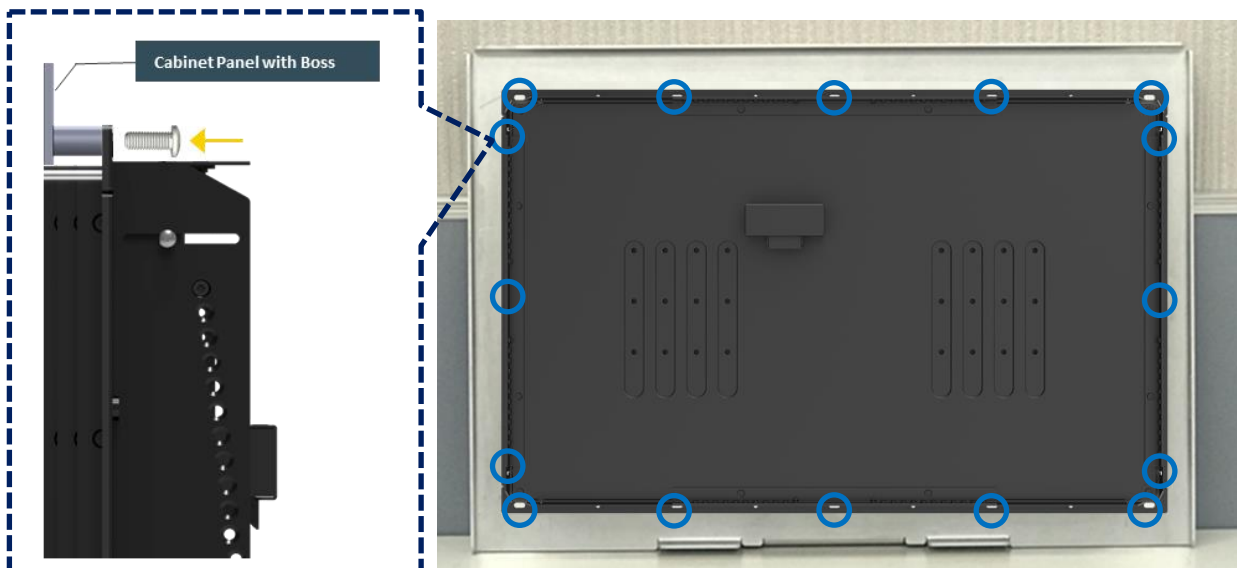

### 3.17 Disassemble the mounting brackets

The CO-100 series currently features two types of Mounting Bracket designs. For example, the Mounting Bracket designs of CO-W121C and CO-119C as illustrated below.



CO-W121C



CO-119C

CO-119C is essentially identical to CO-W121C in terms of installation, with the only difference being the design of the Mounting Bracket. The following steps will demonstrate the installation using CO-W121C as an example.

Before the installation of VESA mount and rack mount, user need to disassemble the mounting brackets on the CO display module first.

Step 1. Remove the 8 screws.



Step 2. Remove the 3 screws on the left and right side of mounting brackets.



Step 3. Remove the 3 screws on the top and bottom side of mounting brackets.



Step 4. Remove the four mounting brackets.



### 3.18 Installing VESA Mount

Before the installation of VESA mount, user need to follow the chapter 3.17 to disassemble the mounting brackets on the CO display module first.

This series supports VESA mounting that customer can mount system with panel complying with VESA 75mm and 100 mm standard for various usage. The 75mm VESA uses blue-circle-marked screw holes. The 100mm VESA uses red-circle-marked screw holes.

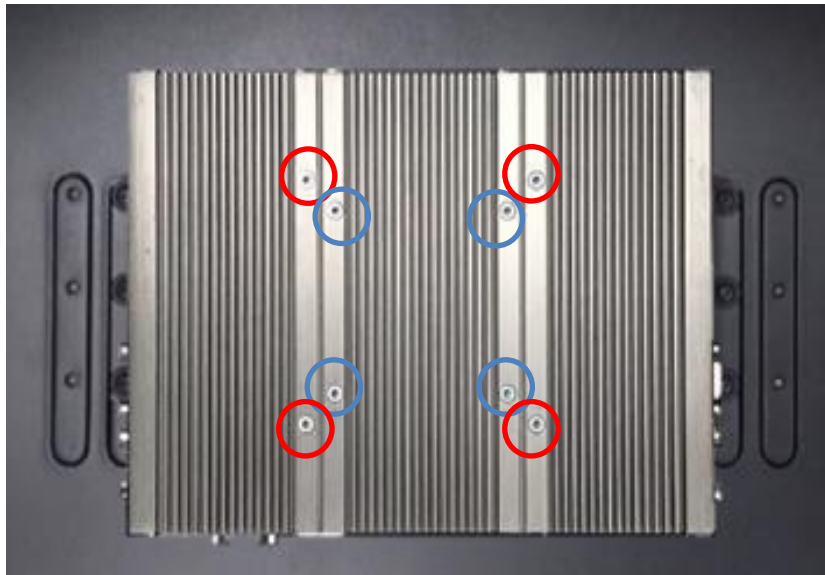

Step 1. Put the VESA stand on, and align with the mounting holes.



Step 2. Fasten the VESA mount screws to complete the VESA mounting.



### 3.19 Installing Rack Mount

Before the installation of rack mount, user need to follow the chapter 3.17 to disassemble the mounting brackets on the CO display module first.

Step 1. Locate the screw holes on the PC or monitor module.

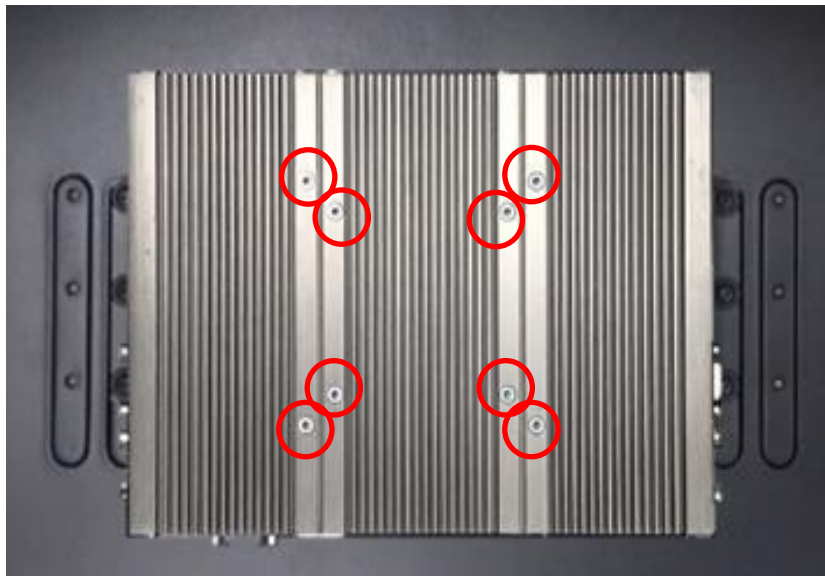

Step 2. Put on the rack mount base and fasten the screws.

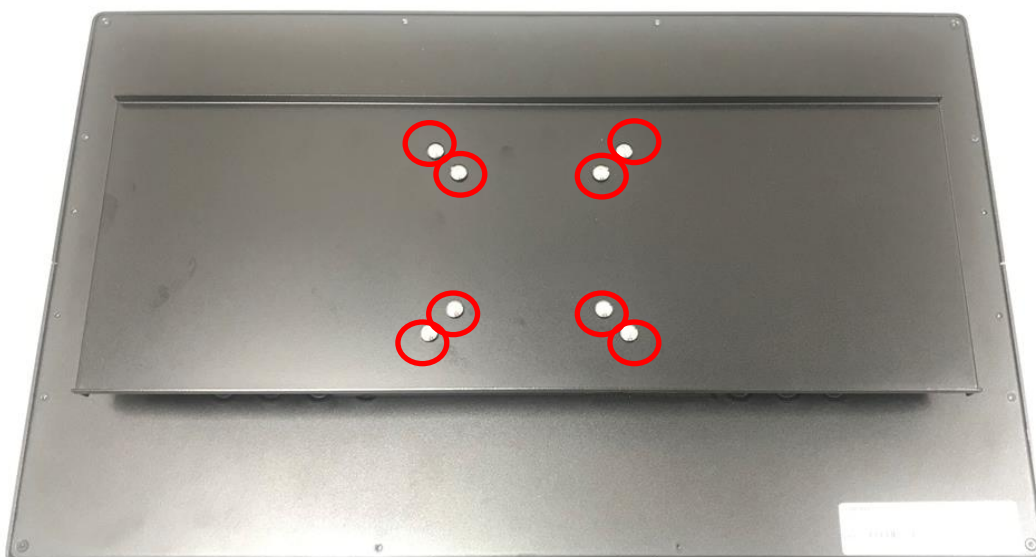

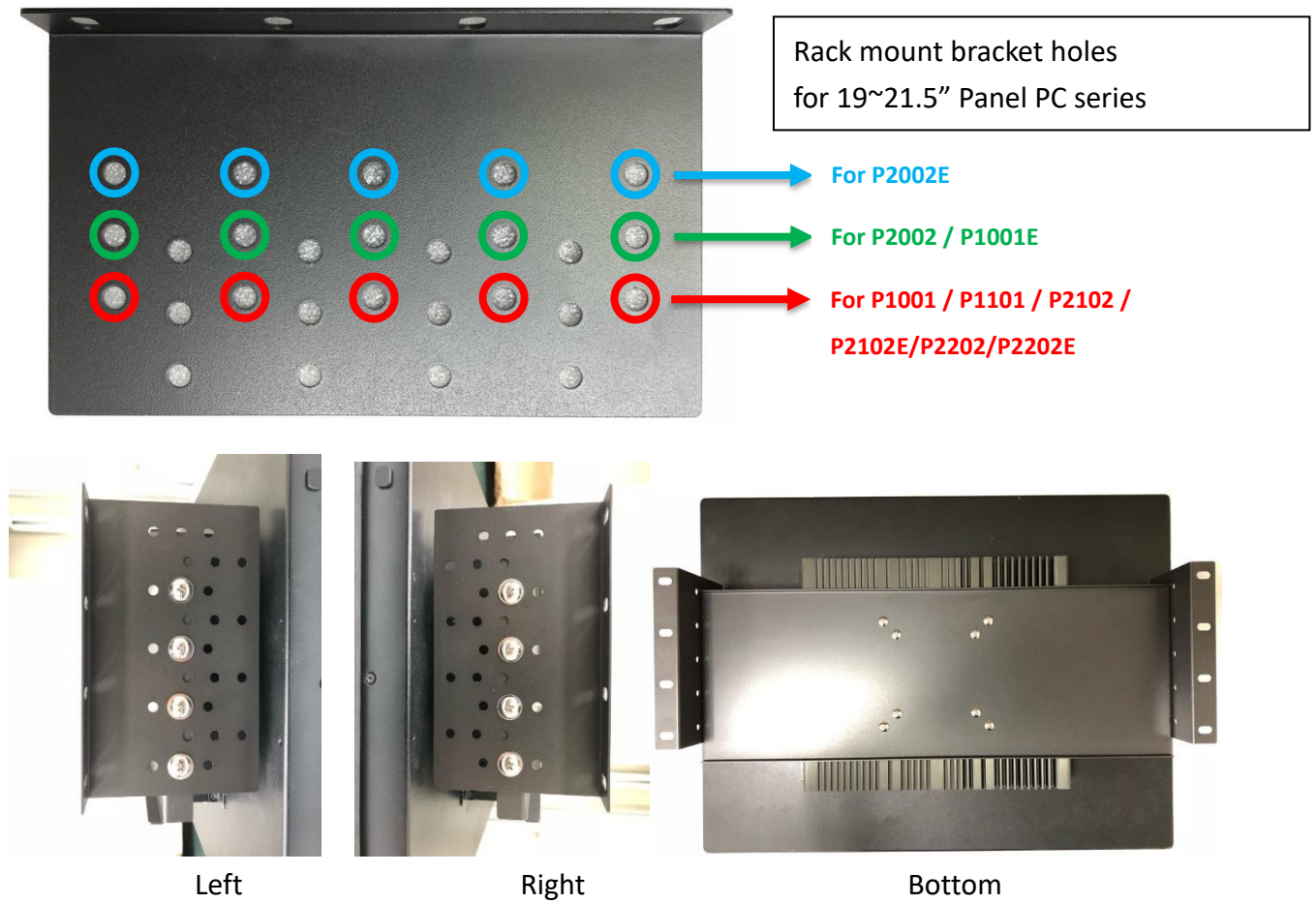

Step 3. Assemble two rack mount brackets by fastening 4 screws (M5x6) at each side.



Step 4. Assemble two rack mount brackets by fastening 4 screws (M5x12), flat washers and hex nuts at each side.







# **Chapter 4**

## **BIOS Setup**

## 4.1 BIOS Introduction

The BIOS (Basic Input/ Output System) is a program located on a Flash Memory on the motherboard. When you start the computer, the BIOS program will gain control. The BIOS first operates an auto-diagnostic test called POST (power on self-test) for all the necessary hardware, it detects the entire hardware device and configures the parameters of the hardware synchronization.

### BIOS Setup

Power on the computer and by pressing <Del> immediately allows you to enter Setup. If the message disappears before your respond and you still wish to enter Setup, restart the system to try again by turning it OFF then ON or pressing <Ctrl>, <Alt> and <Delete> keys.

Control Keys	
<<> <>>	Move to select screen
<↑> <↓>	Move to select item
<Esc>	Quit the BIOS Setup
<Enter>	Select item
<Page Up/+>	Increases the numeric value or makes changes
<Page Down/->	Decreases the numeric value or makes changes
<Tab>	Select setup fields
<F1>	General help
<F2>	Previous value
<F3>	Load Optimized defaults
<F10>	Save configuration and Exit

### Main Menu

The main menu lists the setup functions you can make changes to. You can use the arrow keys ( ↑ ↓ ) to select the item. The on-line description of the highlighted setup function is displayed at the bottom of the screen.

### Sub-Menu

If you find a right pointer symbol appears to the left of certain fields that means a sub-menu can be launched from this field. A sub-menu contains additional options for a field parameter. You can use arrow keys ( ↑ ↓ ) to highlight the field and press <Enter> to call up the sub-menu. Then you can use the control keys to enter values and move from field to field within a sub-menu. If you want to return to the main menu, just press the <Esc >.



## 4.3 Advanced Setup

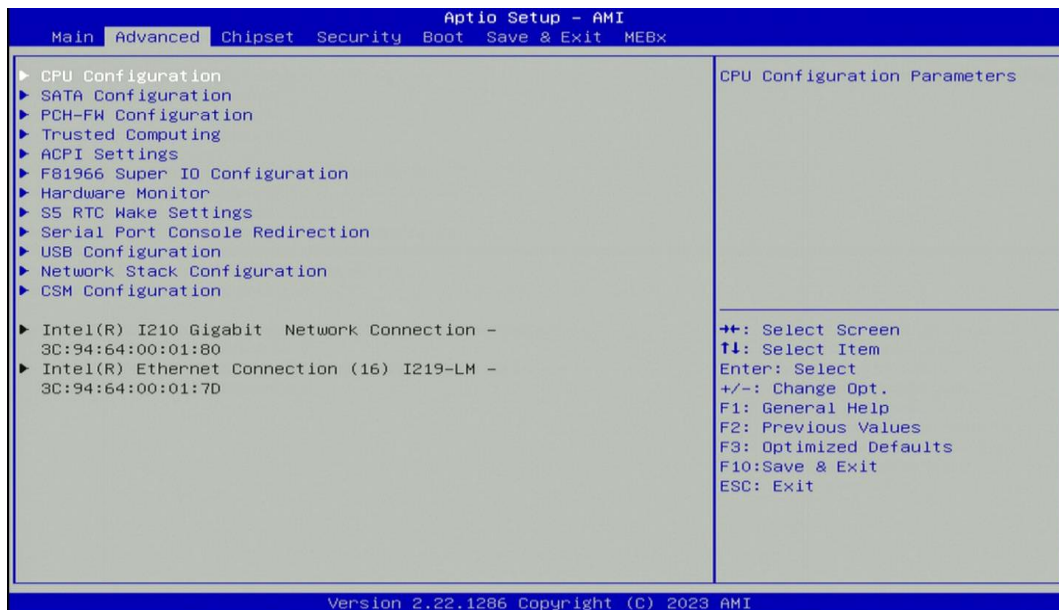

### 4.3.1 CPU Configuration

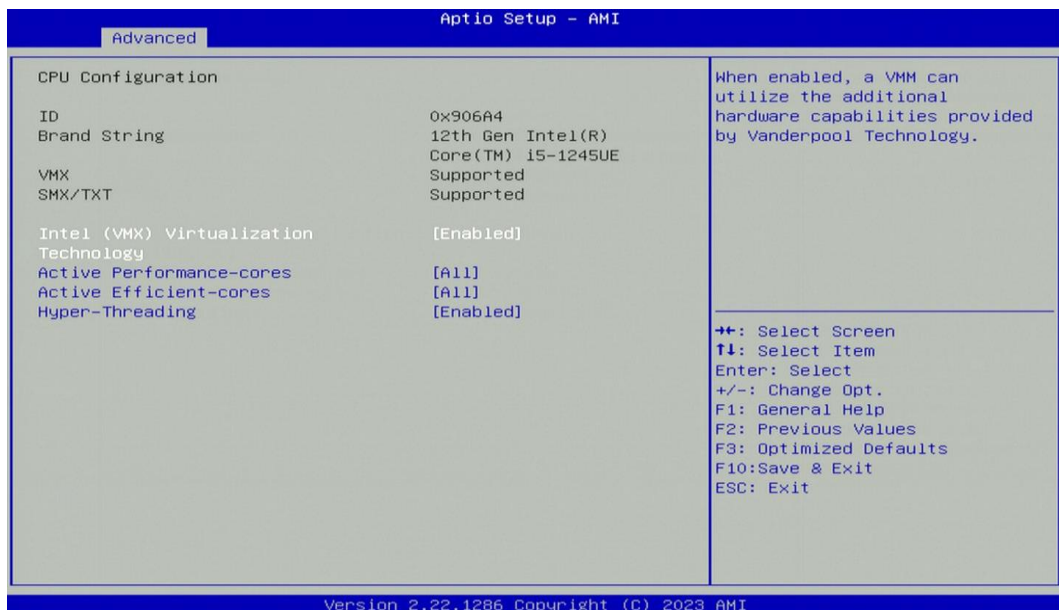

#### ■ Intel® (VMX) Virtualization Technology [Enabled]

Enables or disables Intel® Virtualization Technology. Virtualization enhanced by Intel® Virtualization Technology will allow a platform to run multiple operating systems and applications in independent partitions. With virtualization, one computer system can function as multiple virtual systems.

#### ■ Active Performance-cores [All]

Allows you to choose the number of active performance cores.

Configuration options: [All] [1]

#### ■ Active Efficient-cores [All]

Allows you to choose the number of active efficient cores.

Configuration options: [All] [1] [2] [3] [4] [5] [6] [7]

- **Hyper-Threading [Enabled]**

Allows you to enable or disable Intel® Hyper-Threading function of processor.

### 4.3.2 SATA Configuration

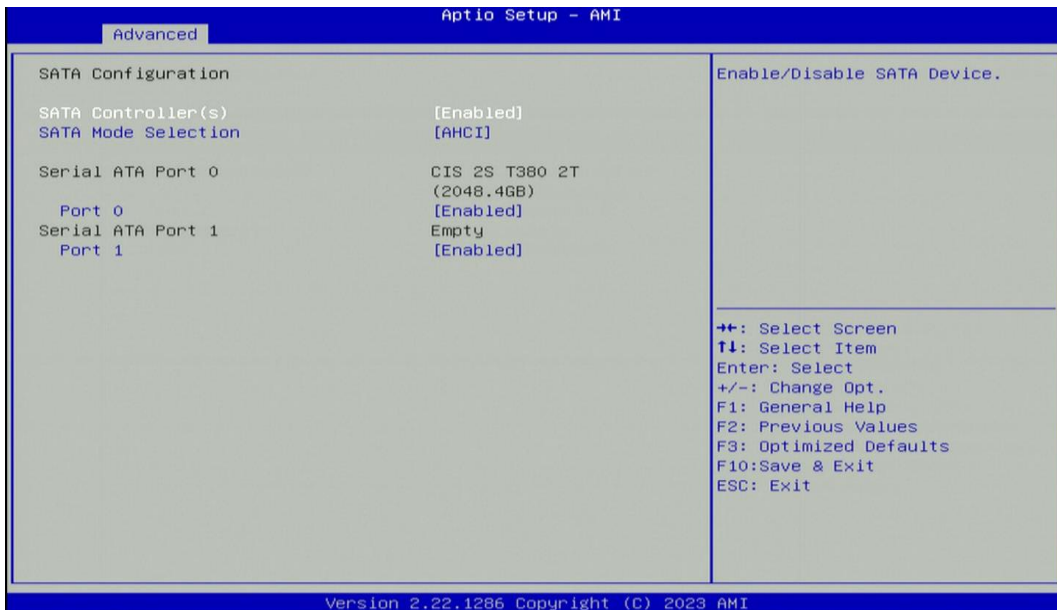

- **SATA Controller(s) [Enabled]**

Enables or disables Serial ATA controller.

- **SATA Mode [AHCI]**

This item allows users to choose [AHCI] mode.

- **Serial ATA Port 0**

- **Port 0 [Enabled]**

Enables or disables SATA Port 0.

- **Serial ATA Port 1**

- **Port 1 [Enabled]**

Enables or disables SATA Port 1.

### 4.3.3 PCH-FW Configuration

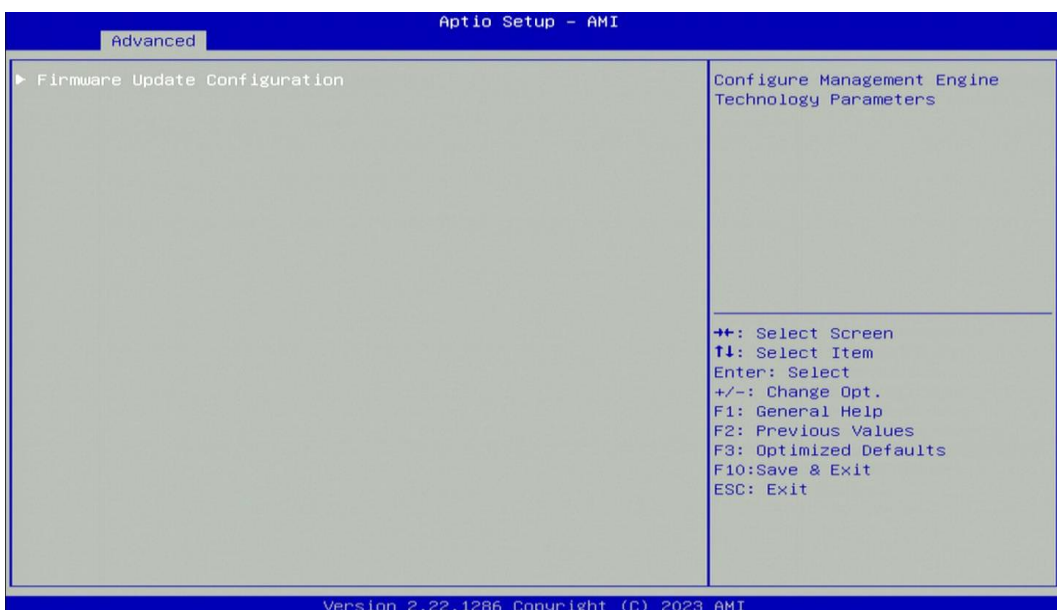

## ❑ Firmware Update Configuration

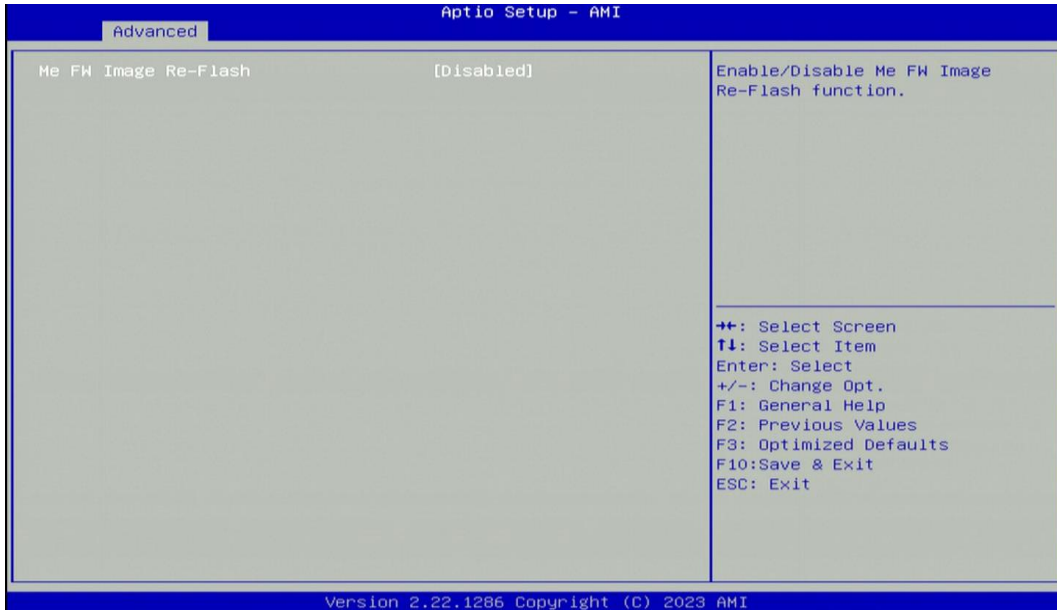

### ■ ME FW Image Re-Flash [Disabled]

Allows you to enable or disable ME firmware image re-flash function.

## 4.3.4 Trusted Computing



### ■ Security Device Support [Enable]

Allow you to enables or disables Security Device Support function.

### ■ SHA256 PCR Bank [Enabled]

Enables or disables SHA256 PCR Bank function.

### ■ SHA384 PCR Bank [Disabled]

Enables or disables SHA384 PCR Bank function.

### ■ SHA3\_256 PCR Bank [Disabled]

Enables or disables SHA3\_256 PCR Bank function.

### ■ Pending Operation [None]

Allows users to select which mode Pending Operation will operate.

Configuration options: [None], [TPM Clear]

- **Platform Hierarchy [Enabled]**

Enables or disables Platform Hierarchy function.

- **Storage Hierarchy [Enabled]**

Enables or disables Storage Hierarchy function.

- **Endorsement Hierarchy [Enabled]**

Enables or disables Endorsement Hierarchy function.

- **Physical Presence Spec Version [1.3]**

Allows users to select which mode Physical Presence Spec Version will operate.

Configuration options: [1.2], [1.3]

### 4.3.5 ACPI Settings

This item allows users to configure ACPI settings.



- **Enable ACPI Auto Configuration [Enabled]**

Enables or disables BIOS Advanced Configuration Power Interface® (ACPI) auto configuration.

- **ACPI Sleep State [S3 (Suspend to RAM)]**

Allows users to select the highest Advanced Configuration Power Interface® (ACPI) sleep state that system will enter when suspend button is pressed.

[Suspend Disabled]: Disables entering suspend state.

[S3 (suspend to RAM)]: Enables suspend to RAM state.

### 4.3.6 F81966 Super IO Configuration

The screen allows users to select options for the Super IO configuration, and change the value of the selected option.

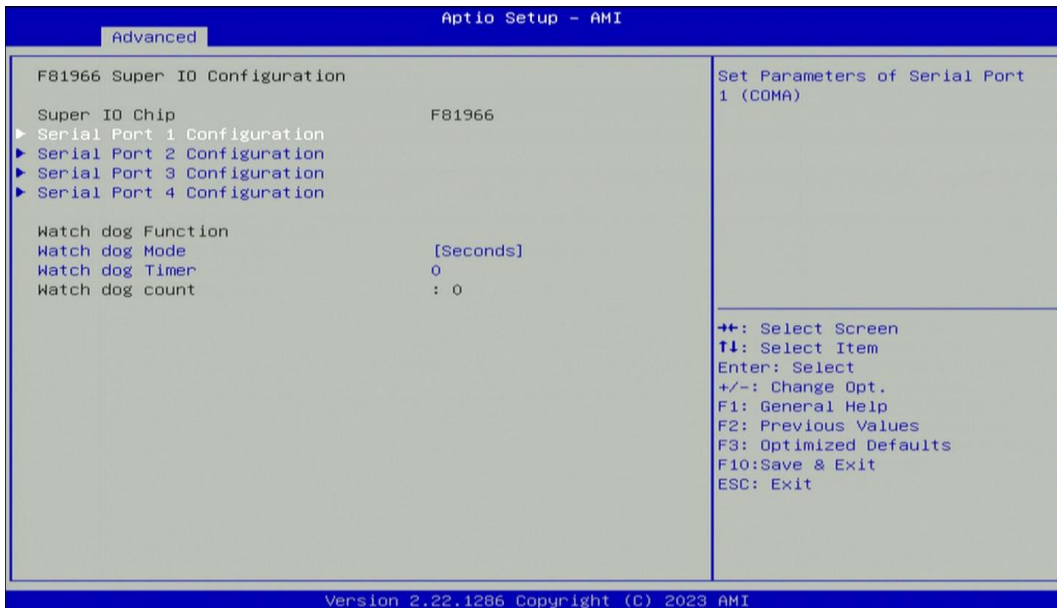

#### Serial Port 1~4 Configuration

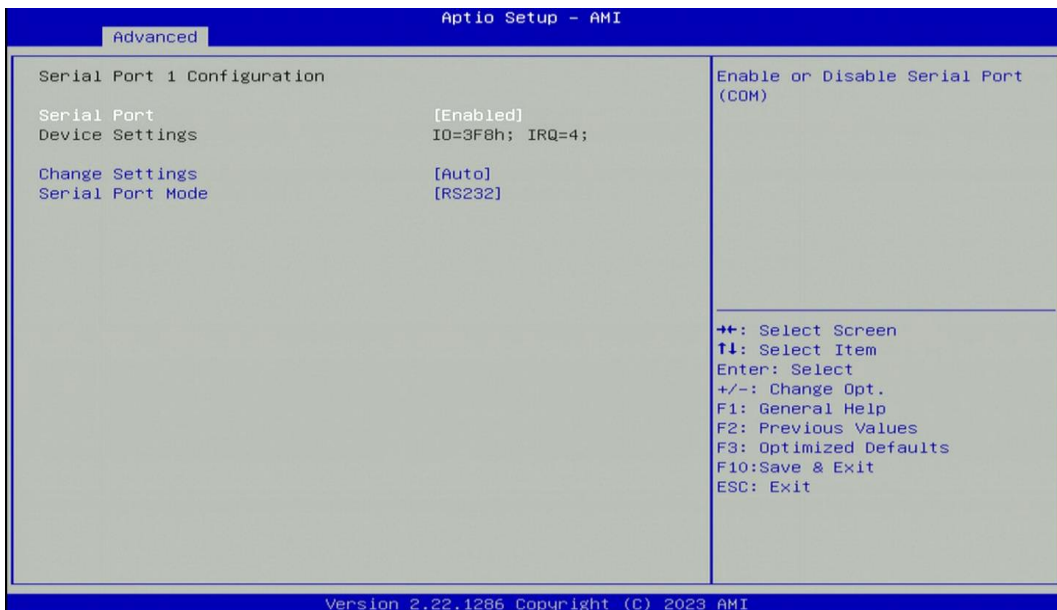

#### Serial Port [Enabled]

This item allows users to enable or disable serial port.

#### Change Settings [Auto]

This item allows users to change the address & IRQ settings of the specified serial port.

#### Onboard Serial Port 1 Mode [RS232]

This item allows users to select Serial Port Mode.

Configuration options: [RS232] [RS422/RS485 Full Duplex] [RS485 Half Duplex]

#### Watch Dog [Disabled]



Enables or disables watch dog function.

- **Watch Dog Mode [Sec]**

Changes the Watch dog mode. Select [Sec] or [Min] mode.

- **Watch Dog Timer [0]**

User can set a value in the range of 0 to 255.

### 4.3.7 Hardware Monitor

These items display the current status of all monitored hardware devices/ components such as voltages and temperatures.

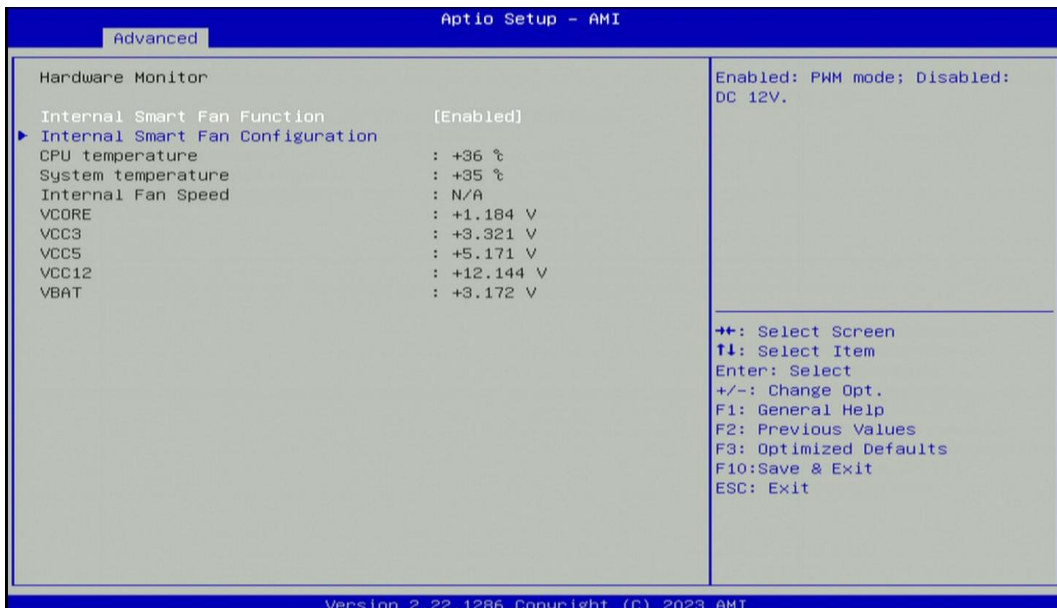

- **Internal Smart Fan Function [Enabled]**

Enables or disables internal smart fan function. Please install the Riser Card (Model: RC-E4-02) and plug the power cord of the internal smart fan into the power socket on the Riser Card to effectively enable this function.

- **Internal Smart Fan Configuration**

Allows users to setting internal smart fan parameters.

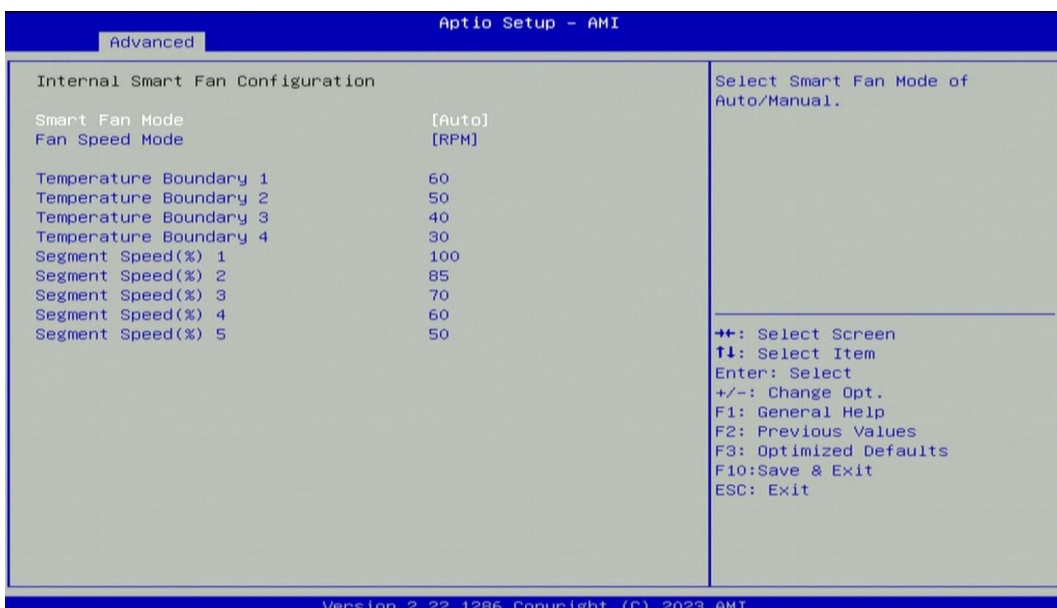

- **Smart Fan Mode [Auto]**

This item allows users to select Auto or Manual for smart fan mode.

- **Fan Speed Mode [RPM]**

This item allows users to select RPM or Duty for fan speed mode.

#### 4.3.8 S5 RTC Wake Settings



- **Wake System from S5 [Disabled]**

This item allows users to change the way to wake system from S5 state.

[Fixed Time]: Set the specified time (HH:MM:SS) to wake system.

[Dynamic Time]: Set the increase time from current time to wake system.

#### 4.3.9 Serial Port Console Redirection

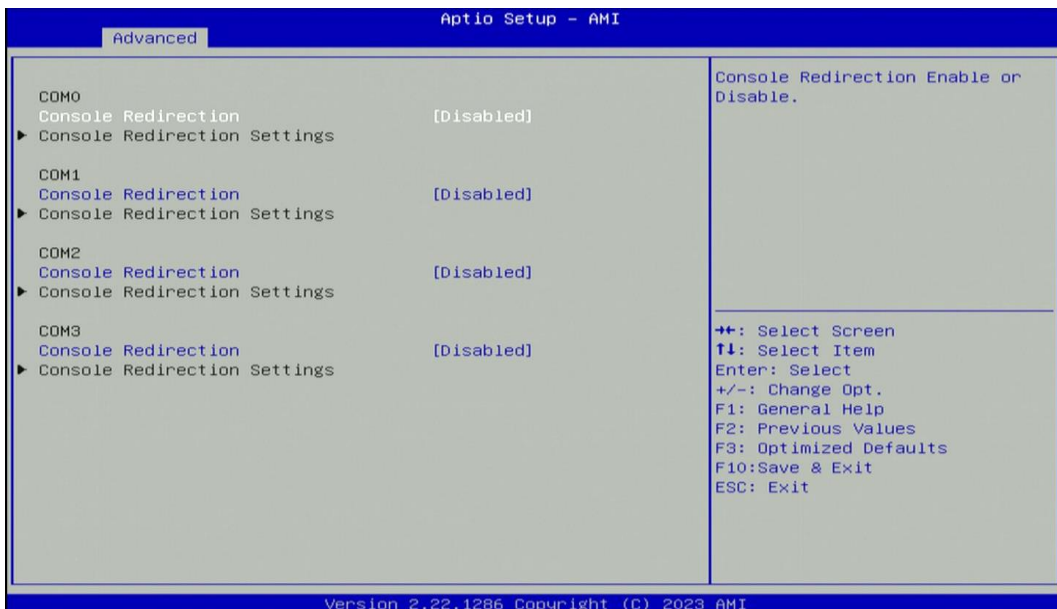

- **Console Redirection [Disabled]**

These items allow users to enable or disable COM0, COM1, COM2, Com3 console redirection function.

### 4.3.10 USB Configuration

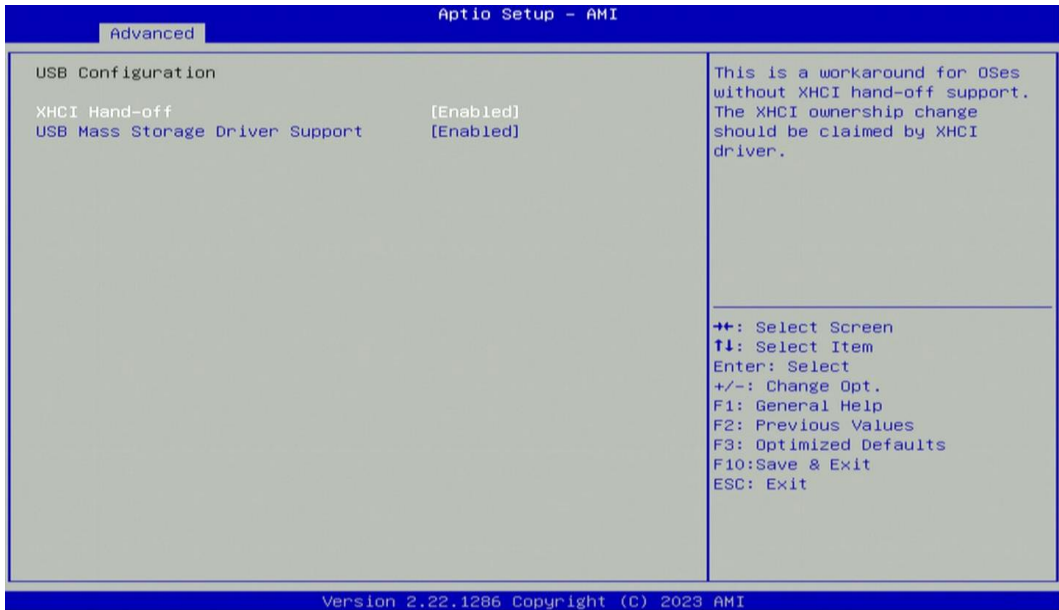

- **XHCI Hand-off [Enabled]**

This item allows users to enable or disable XHCI (USB3.2) hand-off function.

- **USB Mass Storage Driver Support [Enabled]**

Enables or disables support for USB mass storage devices.

### 4.3.11 Network Stack Configuration



- **Network Stack [Disabled]**

Enables or disables UEFI Network Stack.

### 4.3.12 CSM Configuration

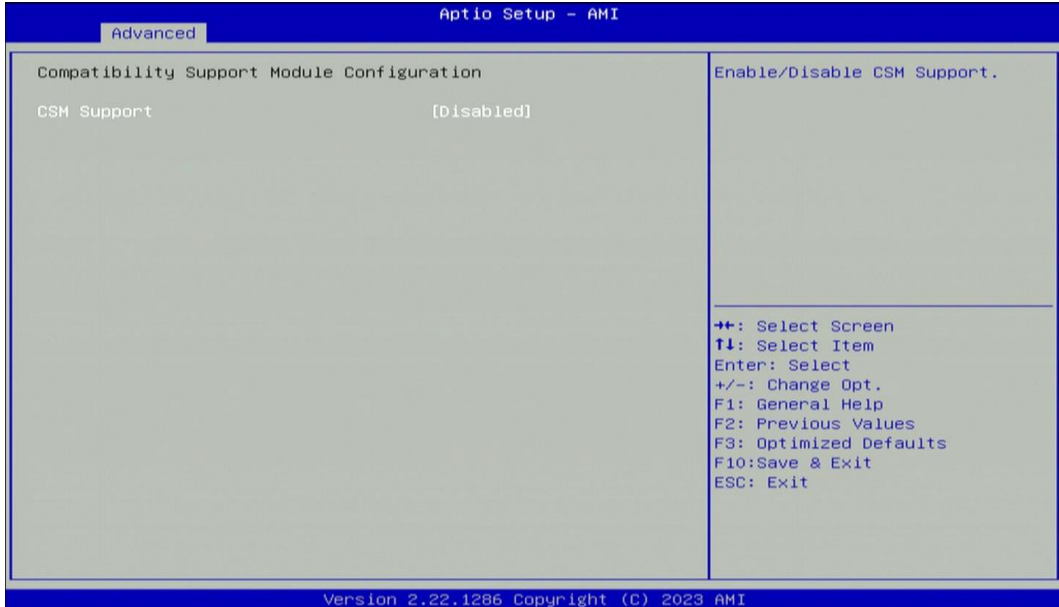

#### ■ CSM Support [Disabled]

This item allows users to enable or disable UEFI Compatibility Support Module (CSM) to support a legacy PC boot process.

## 4.4 Chipset Setup

This section allows you to configure chipset related settings according to user's preference.

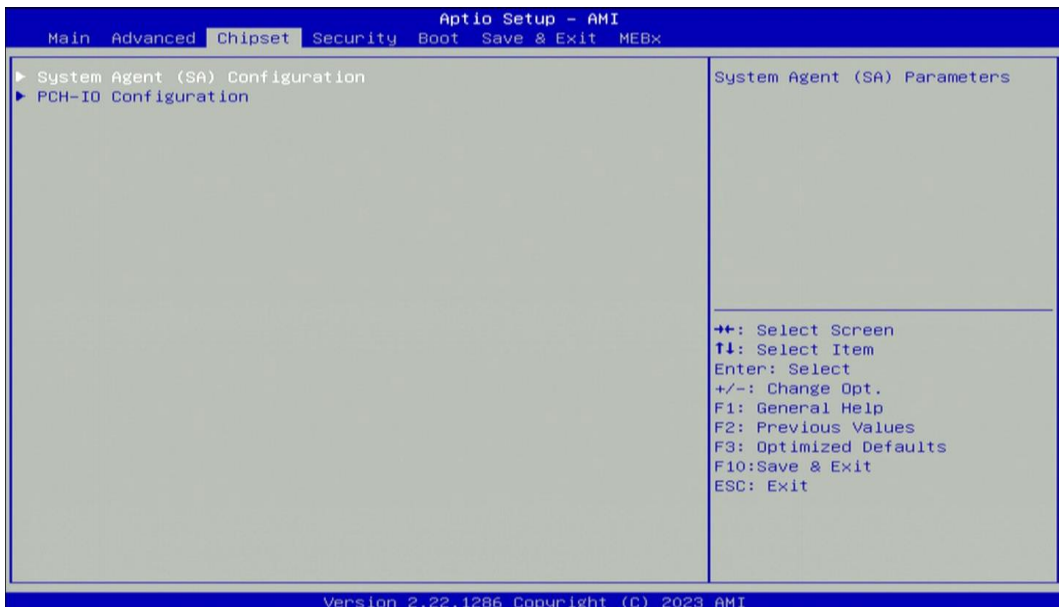

## 4.4.1 System Agent (SA) Configuration

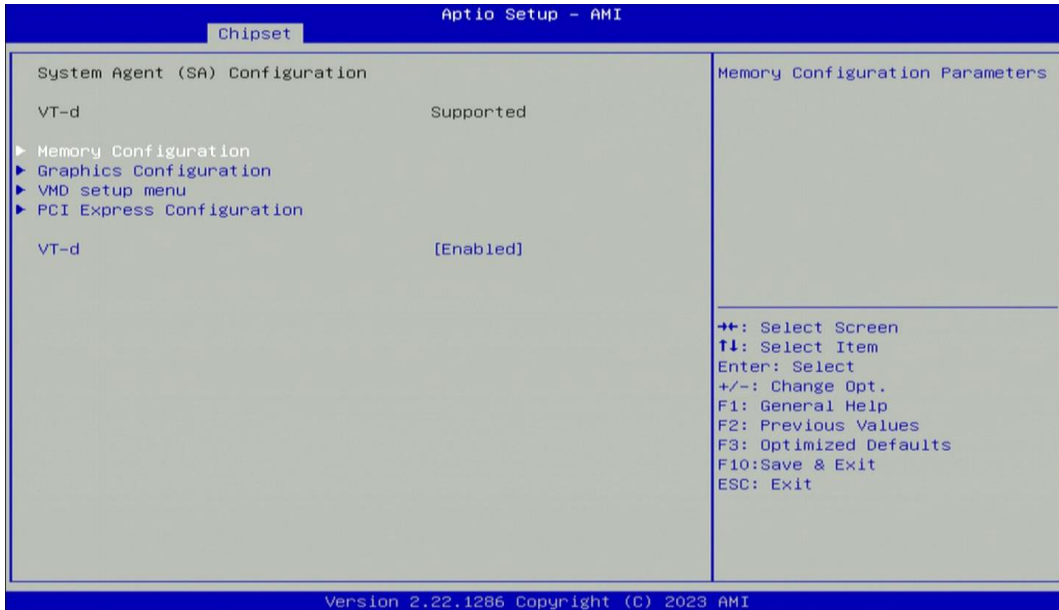

### ❑ Memory Configuration

This item displays detailed memory information in the system.

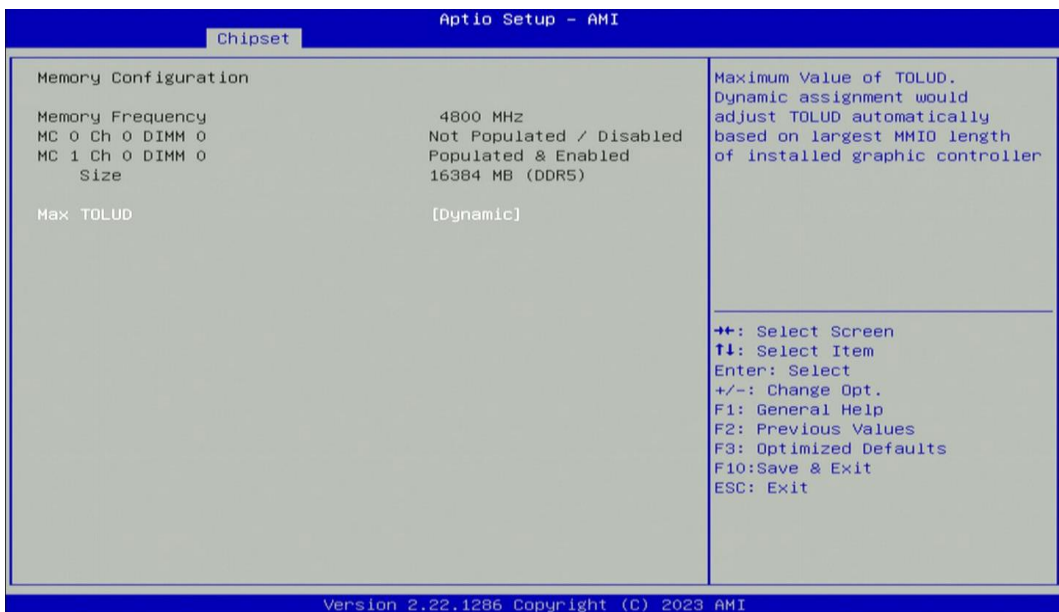

### ■ Max TOLUD [Dynamic]

This item allows users to select maximum value of TOLUD.

## ❑ Graphics Configuration

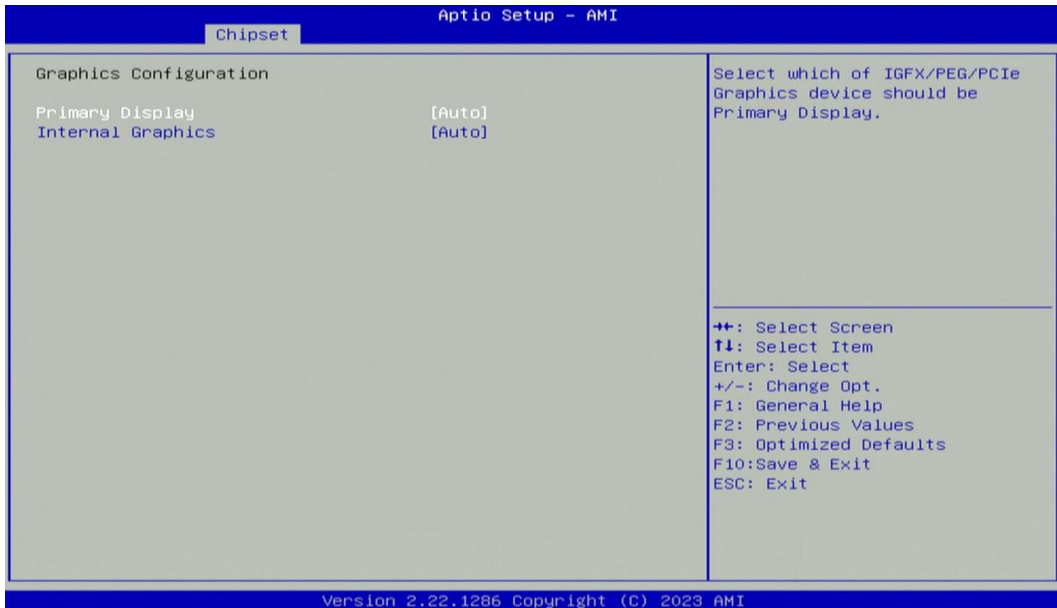

### ■ Primary Display [Auto]

Allows users to select which graphics device should be primary display or select SG for switchable graphics. Configuration options: [Auto] [IGFX] [PEG Slot] [PCIe]

### ■ Internal Graphics [Auto]

This item allows users to enable or disable Internal Graphics. When set to [Auto], it will detect by BIOS. Configuration options: [Auto] [Disabled] [Enabled]

## ❑ VMD Setup Menu



### ■ Enable VMD controller [Disabled]

This item allows users to enable or disable VMD controller. Enable this function can support creating RAID.

## ❑ PCI Express Configuration

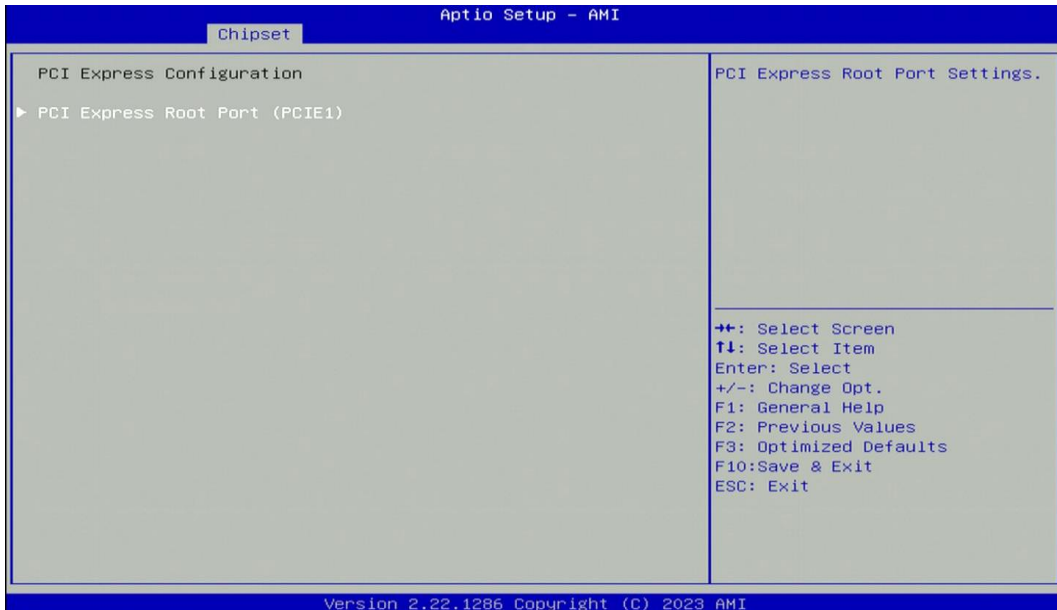

## ❑ PCI Express Configuration

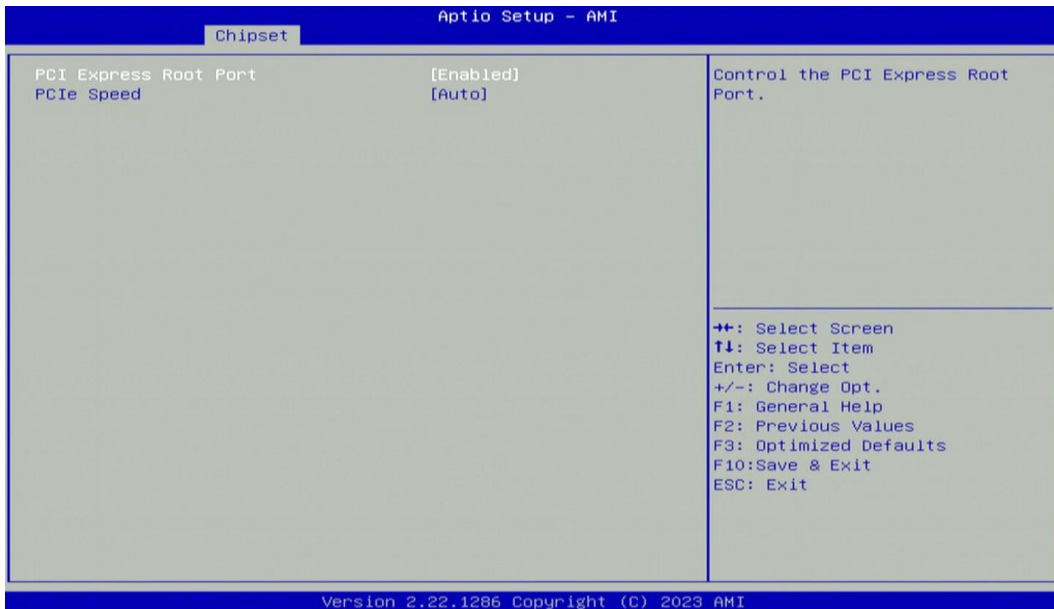

### ■ PCI Express Root Port [Enabled]

Allows you to enable or disable the PCI Express Port.

### ■ PCIe Speed [Auto]

Allows you to select PCI Express interface speed.

Configuration options: [Auto] [Gen1] [Gen2] [Gen3] [Gen4].

## ❑ VT-d [Enabled]

This item allows users to enable or disable Intel® Virtualization Technology for Directed I/O (VT-d) function.

## 4.4.2 PCH-IO Configuration

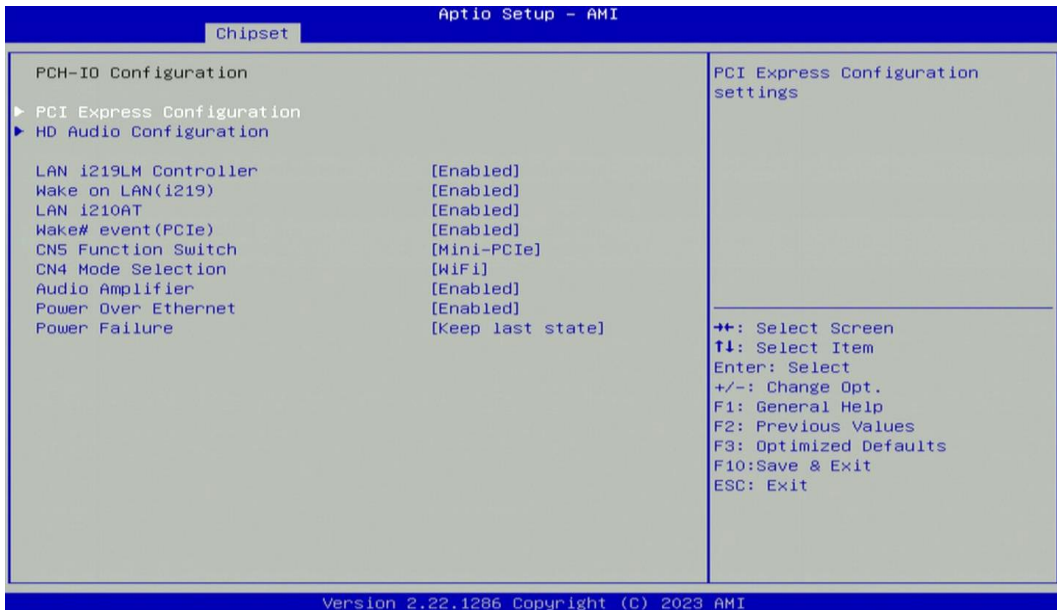

### ❑ PCI Express Configuration



### ❑ PCI Express Root Port(CN5)

#### ■ PCI Express Root Port [Enabled]

Allows you to enable or disable the PCI Express Port.

#### ■ PCIe Speed [Auto]

Allows you to select PCI Express interface speed.

Configuration options: [Auto] [Gen1] [Gen2] [Gen3].

### ❑ PCI Express Root Port(CN3)

#### ■ PCI Express Root Port [Enabled]

Allows you to enable or disable the PCI Express Port.

#### ■ PCIe Speed [Auto]

Allows you to select PCI Express interface speed.



Configuration options: [Auto] [Gen1] [Gen2] [Gen3].

**PCI Express Root Port(CN4)**

■ **PCI Express Root Port [Enabled]**

Allows you to enable or disable the PCI Express Port.

■ **PCIe Speed [Auto]**

Allows you to select PCI Express interface speed.

Configuration options: [Auto] [Gen1] [Gen2] [Gen3].

**HD Audio Configuration**

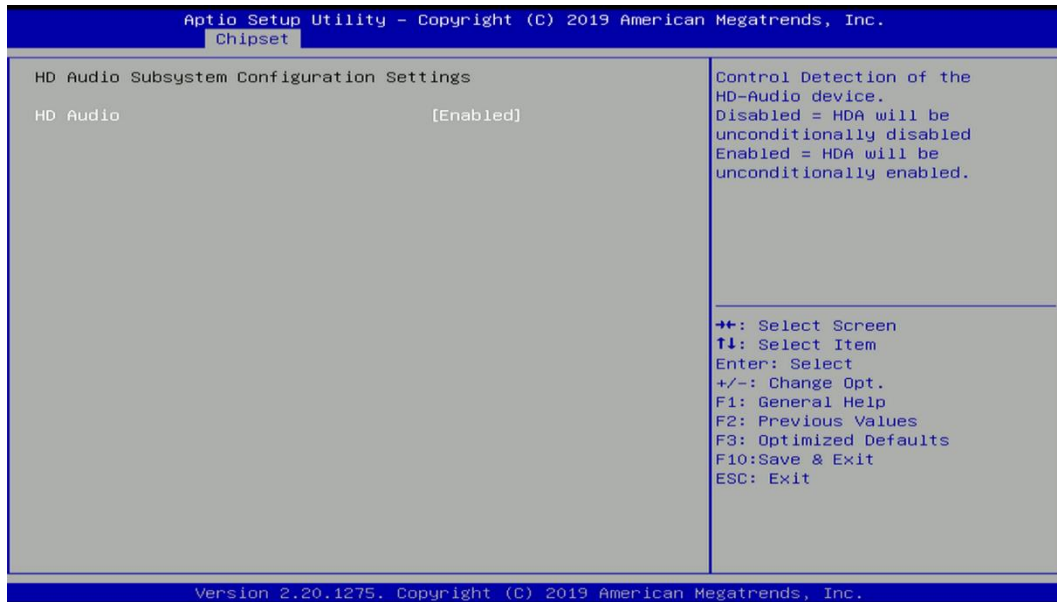

■ **HD Audio [Enabled]**

Allows you to select HD Audio options.

[Enabled]: HD Audio device is unconditionally enabled.

[Disabled]: HD Audio device is unconditionally disabled.

■ **LAN i219LM Controller [Enabled]**

Enables or disables i219LM LAN Controller.

■ **Wake On LAN (i219) [Enabled]**

Enables or disables integrated LAN i219LM Wake On LAN function.

■ **LAN i210AT Controller [Enabled]**

Enables or disables i210 LAN Controller.

■ **Wake# event (PCIe) [Enabled]**

Enables or disables integrated LAN i210 Wake On LAN function.

■ **CN5 Function Switch [Mini-PCIe]**

Select Mini-PCIe/USB3.0 for CN5 connector.

■ **CN4 Function Switch [Wifi]**

Select CNV/Wifi(PCIe) for CN4 connector.

■ **Audio Amplifier [Enabled]**

Enable or disable Audio Amplifier.

- **Power Over Ethernet Function [Enabled]**

Enable or disable Power Over Ethernet (POE) function.

- **Power Failure [Keep last state]**

Allows you to specify which power state system will enter when power is resumed after a power failure (G3 state).

[Always on]: Enters to power on state.

[Always off]: Enters to power off state.

[Keep last state]: Enters to the last power state before a power failure.

## 4.5 Security Setup

This section allows users to configure BIOS security settings.

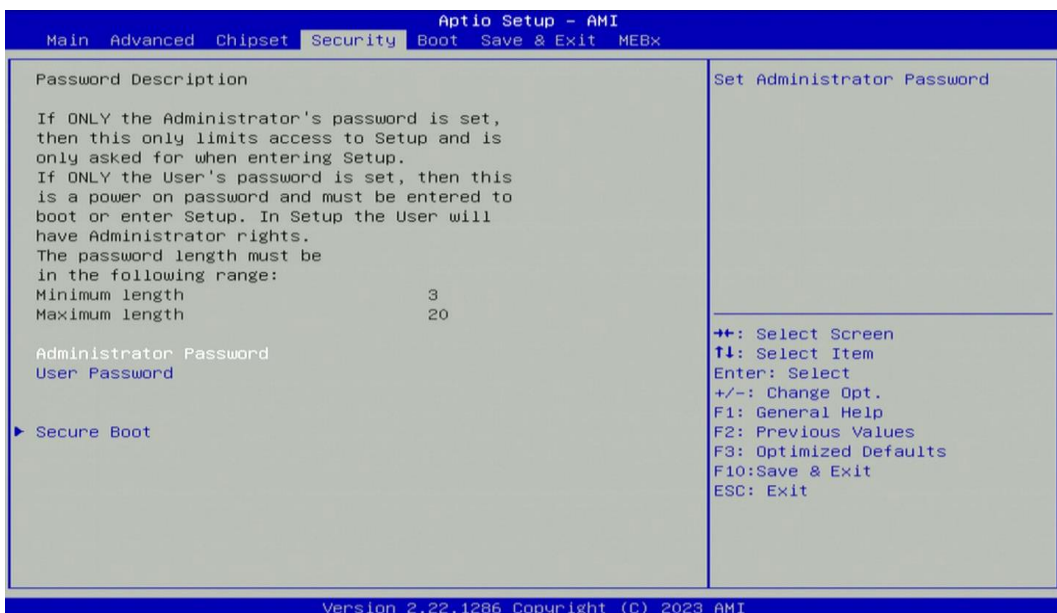

### 4.5.1 Administrator Password

Administrator Password controls access to the BIOS Setup utility.

### 4.5.2 User Password

User Password controls access to the system at boot and to the BIOS Setup utility.

### 4.5.3 Security Boot

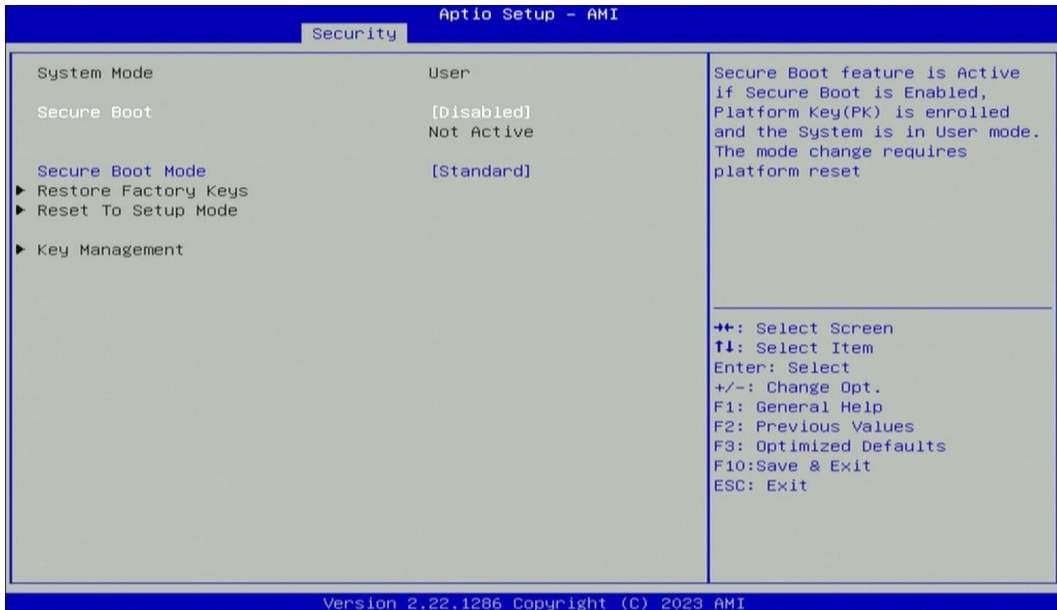

#### Secure Boot [Disabled]

Enable or disable Secure Boot function.

#### Secure Boot Mode [Standard]

Allows you to select Secure Boot Mode.

Configuration options: [Standard] [Custom].

## 4.6 Boot Setup

This section allows you to configure Boot settings.

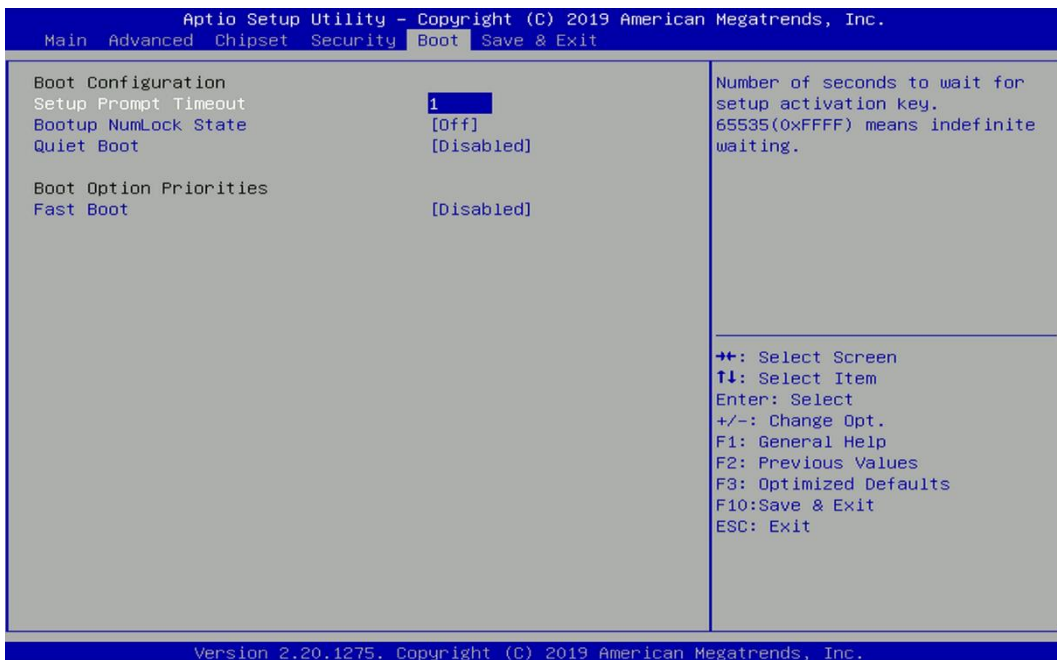

#### 4.6.1 Setup Prompt Timeout [1]

Use this item to set number of seconds (1..65535) to wait for setup activation key.

#### 4.6.2 Bootup NumLock State [Off]

Allows you to select the power-on state for keyboard NumLock.

#### 4.6.3 Quiet Boot [Disabled]

Allows you to enable or disable Quiet Boot function.

#### 4.6.4 Fast Boot [Disabled]

Allows you to enable or disable Fast Boot function.

## 4.7 Save & Exit

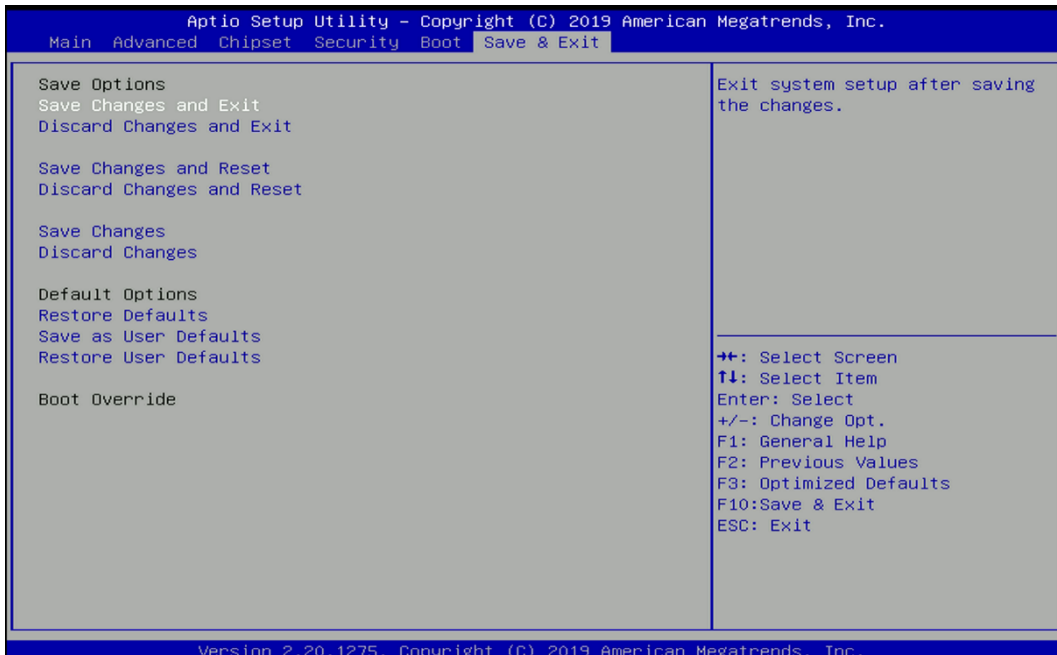

#### 4.7.1 Save Changes and Exit

This item allows you to exit system setup after saving changes.

#### 4.7.2 Discard Changes and Exit

This item allows you to exit system setup without saving changes.

#### 4.7.3 Save Changes and Reset

This item allows you to reset the system after saving changes.

#### 4.7.4 Discard Changes and Reset

This item allows you to reset system setup without saving any changes.

#### 4.7.5 Save Changes

This item allows you to save changes done so far to any of the setup options.

#### 4.7.6 Discard Changes

This item allows you to discard changes done so far to any of the setup options.

#### 4.7.7 Restore Defaults

This item allows you to restore/ load default values for all the options.

#### 4.7.8 Save as User Defaults

This item allows you to save the changes done so far as user defaults.

#### 4.7.9 Restore User Defaults

This item allows you to restore the user defaults to all the options.

## 4.8 MEBx

This page is for ME function setting. Press the delete key to enter the BIOS menu then user can see the following MEBx page.

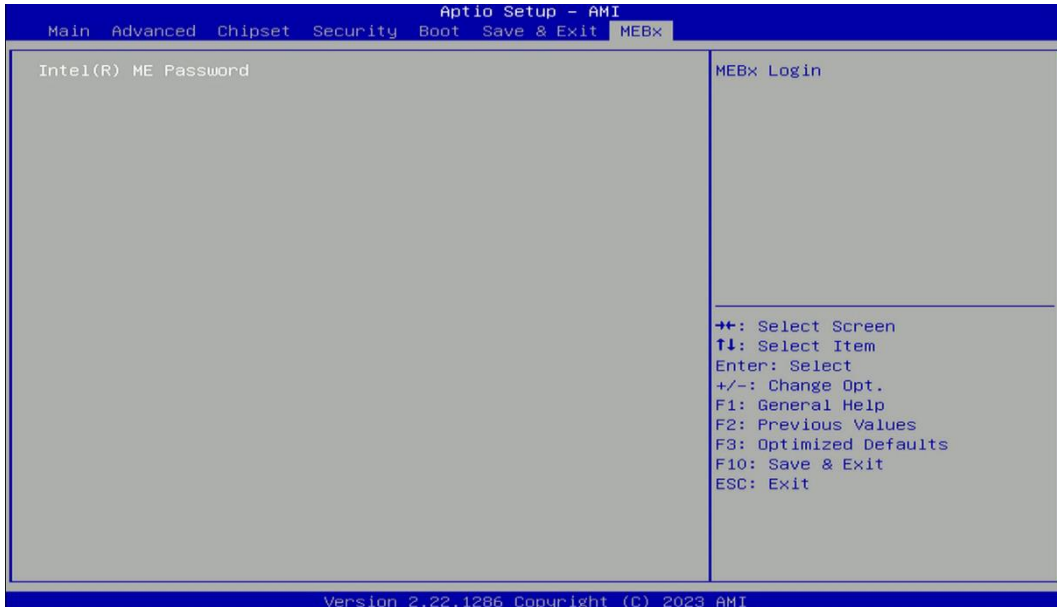

Press enter key to enter the default password "admin" to enter the next step for password creation.

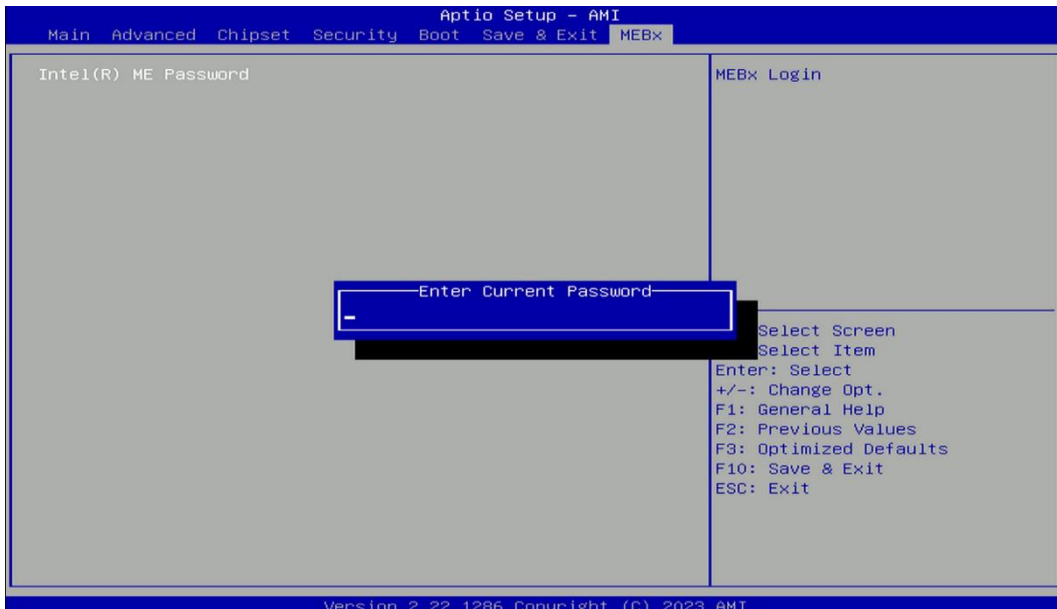

Create a new password using 8 characters including uppercase and lowercase letters, numbers and special symbols.

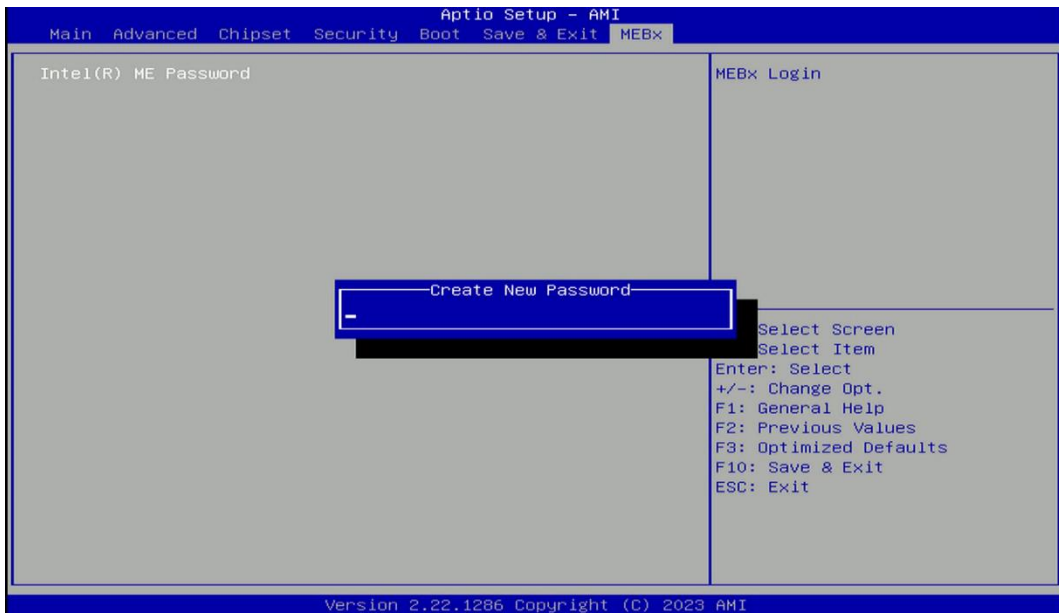

Enter the created password again for confirmation.

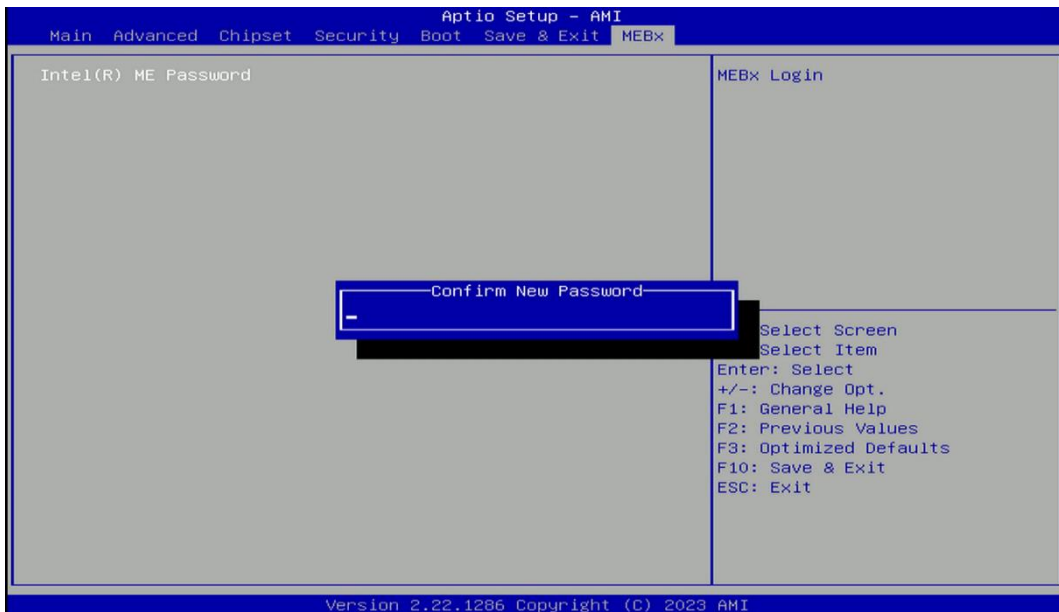

Then you can see the function setting page of MEBx.

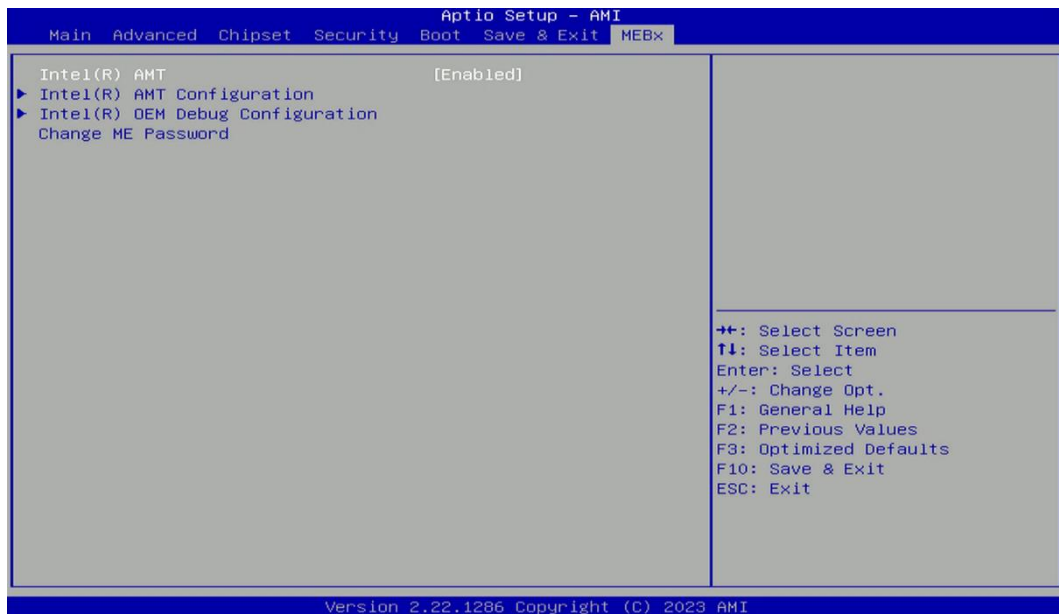



# **Chapter 5**

## **Product Application**



## 5.1 Where to download drivers?

Please go to the CINCOZE website to download the drivers for P2202 series.

## 5.2 Where to find the technical documents?

Please go to the [CINCOZE website](#) to find the technical documents for P2202 series.

Catalog	Document Title
Application Notes	DIO Application Guide
	DIO Technical Guide
	Instant Reboot Application Guide
	WDT Application Guide
	WDT Technical Guide
Configure & Installation	AT ATX Function Manual
	BIOS Administrator User Password Function Manual
	Clear CMOS Function Manual
	COM Function Manual
	CSM Function Manual
	Digital I/O Function Manual
	How to import Secure Boot Key?
	How to restore Windows image with Clonezilla?
	How to set TPM function under Windows?
	How to stop automatic driver update in Windows SOP
	How to Update BIOS and ME under UEFI shell?
	How to Update BIOS under UEFI shell?
	How to Update BIOS under Windows?
	IGN Module User Manual
	Intel AMT with KVM Remote Control
	POE Module User Manual
	PXE Function Manual
	RAID Function Manual
	Remote Switch Function Manual
	Wake On LAN Function Manual
WDT Function Manual	

***cincoze***

© 2023 Cincoze Co., Ltd. All rights reserved.

The Cincoze logo is a registered trademark of Cincoze Co., Ltd.

All other logos appearing in this catalog are the intellectual property of the respective company, product, or organization associated with the logo.

All product specifications and information are subject to change without notice.