

***cincoze***

# CO-100/P1101 Series

## User Manual



### Open Frame Panel PC

TFT LCD Open Frame Panel PC with Intel® Atom® / Pentium® Processor

# Contents

Preface .....	5
Revision .....	5
Copyright Notice .....	5
Acknowledgement .....	5
Disclaimer.....	5
Declaration of Conformity.....	6
Product Warranty Statement .....	6
Technical Support and Assistance .....	8
Conventions Used in this Manual .....	8
Safety Precautions.....	9
Package Contents .....	10
Ordering Information .....	10
Chapter 1 Product Introductions .....	11
1.1 Overview .....	12
1.2 Highlights.....	12
1.3 Key Features .....	13
1.4 Hardware Specification .....	14
1.4.1 CO-119C-R10/P1101 Series .....	14
1.4.2 CO-W121C-R10/P1101 Series.....	18
1.5 System I/O.....	22
1.5.1 Front .....	22
1.5.2 Rear.....	22
1.5.3 Left.....	23
1.5.4 Right.....	23
Chapter 2 Switches & Connectors.....	24
2.1 Location of Switches and Connectors .....	25
2.1.1 Top View .....	25
2.1.2 Bottom View .....	26
2.2 Switches and Connectors Definition .....	27
2.3 Definition of Switches .....	27
2.4 Definition of Connectors .....	30
Chapter 3 System Setup .....	34
3.1 Removing Top Cover.....	35
3.2 Installing SO-DIMM Memory .....	36
3.3 Installing Mini-PCIe Card .....	37
3.4 Installing Antenna(s) .....	38
3.5 Installing CPU Thermal Pad .....	40

3.6 Installing Top Cover .....	41
3.7 Installing SATA Hard Drive .....	42
3.8 Installing SIM Card .....	44
3.9 Disassemble the CO Display Module .....	45
3.10 Installing Standard Mount.....	46
3.10.1 Fixing from front side.....	47
3.10.2 Fixing from rear side .....	48
3.11 Flat Mount.....	49
3.11.1 Fixing from front side.....	54
3.11.2 Fixing from rear side .....	55
3.12 Disassemble the mounting brackets .....	56
Chapter 4 BIOS Setup .....	58
4.1 BIOS Introduction.....	59
4.2 Main Setup .....	60
4.2.1 System Date .....	60
4.2.2 System Time.....	60
4.3 Advanced Setup .....	61
4.3.1 Trusted Computing Settings .....	61
4.3.2 ACPI Settings.....	62
4.3.3 F81866 Super IO Configuration .....	63
4.3.4 Hardware Monitor .....	64
4.3.5 S5 RTC Wake Settings .....	65
4.3.6 Serial Port Console Redirection .....	65
4.3.7 CPU Configuration .....	66
4.3.8 Network Stack Configuration.....	66
4.3.9 CSM Configuration.....	67
4.3.10 USB Configuration.....	68
4.4 Chipset Setup .....	69
4.4.1 North Bridge .....	69
4.4.2 South Bridge .....	70
4.4.3 South Cluster Configuration .....	71
4.5 Security Setup .....	74
4.5.1 Administrator Password .....	74
4.5.2 User Password .....	74
4.6 Boot Setup.....	75
4.7 Save & Exit.....	76
Chapter 5 Product Application .....	77
5.1 Digital I/O (DIO) application .....	78
5.1.1 Digital I/O Programming Guide .....	78

5.2 Digital I/O (DIO) Hardware Specification .....	84
5.2.1 DIO Connector Definition .....	85
Chapter 6 Optional Modules and Accessories .....	86
6.1 Location of the Connectors and Switches .....	87
6.2 Installing CFM-IGN Module .....	88
6.3 Installing CFM-PoE Module .....	90
6.4 Installing VESA Mount .....	92
6.5 Installing Rack Mount .....	94

# Preface

## Revision

Revision	Description	Date
1.00	First Released	2022/09/05
1.01	Correction Made	2023/04/14
1.02	Correction Made	2023/11/30

## Copyright Notice

© 2022 by Cincoze Co., Ltd. All rights are reserved. No parts of this manual may be copied, modified, or reproduced in any form or by any means for commercial use without the prior written permission of Cincoze Co., Ltd. All information and specification provided in this manual are for reference only and remain subject to change without prior notice.

## Acknowledgement

Cincoze is a registered trademark of Cincoze Co., Ltd. All registered trademarks and product names mentioned herein are used for identification purposes only and may be trademarks and/or registered trademarks of their respective owners.

## Disclaimer

This manual is intended to be used as a practical and informative guide only and is subject to change without notice. It does not represent a commitment on the part of Cincoze. This product might include unintentional technical or typographical errors. Changes are periodically made to the information herein to correct such errors, and these changes are incorporated into new editions of the publication.

## Declaration of Conformity



### FCC

This equipment has been tested and found to comply with the limits for a Class A digital device, pursuant to Part 15 of the FCC Rules. These limits are designed to provide reasonable protection against harmful interference when the equipment is operated in a commercial environment. This equipment generates, uses, and can radiate radio frequency energy and, if not installed and used in accordance with the instruction manual, may cause harmful interference to radio communications. Operation of this equipment in a residential area is likely to cause harmful interference in which case the user will be required to correct the interference at his own expense.



### CE

The product(s) described in this manual complies with all application European Union (CE) directives if it has a CE marking. For computer systems to remain CE compliant, only CE-compliant parts may be used. Maintaining CE compliance also requires proper cable and cabling techniques.

## Product Warranty Statement

### Warranty

Cincoze products are warranted by Cincoze Co., Ltd. to be free from defect in materials and workmanship for 2 years (2 Years for PC Module, 1 Year for Display Module) from the date of purchase by the original purchaser. During the warranty period, we shall, at our option, either repair or replace any product that proves to be defective under normal operation. Defects, malfunctions, or failures of the warranted product caused by damage resulting from natural disasters (such as by lightning, flood, earthquake, etc.), environmental and atmospheric disturbances, other external forces such as power line disturbances, plugging the board in under power, or incorrect cabling, and damage caused by misuse, abuse, and unauthorized alteration or repair, and the product in question is either software, or an expendable item (such as a fuse, battery, etc.), are not warranted.

### RMA

Before sending your product in, you will need to fill in Cincoze RMA Request Form and obtain an RMA number from us. Our staff is available at any time to provide you with the most friendly and immediate service.

## ■ RMA Instruction

- Customers must fill in Cincoze Return Merchandise Authorization (RMA) Request Form and obtain an RMA number prior to returning a defective product to Cincoze for service.
- Customers must collect all the information about the problems encountered and note anything abnormal and describe the problems on the “Cincoze Service Form” for the RMA number apply process.
- Charges may be incurred for certain repairs. Cincoze will charge for repairs to products whose warranty period has expired. Cincoze will also charge for repairs to products if the damage resulted from acts of God, environmental or atmospheric disturbances, or other external forces through misuse, abuse, or unauthorized alteration or repair. If charges will be incurred for a repair, Cincoze lists all charges, and will wait for customer’s approval before performing the repair.
- Customers agree to ensure the product or assume the risk of loss or damage during transit, to prepay shipping charges, and to use the original shipping container or equivalent.
- Customers can be sent back the faulty products with or without accessories (manuals, cable, etc.) and any components from the system. If the components were suspected as part of the problems, please note clearly which components are included. Otherwise, Cincoze is not responsible for the devices/parts.
- Repaired items will be shipped along with a "Repair Report" detailing the findings and actions taken.

## **Limitation of Liability**

Cincoze’ liability arising out of the manufacture, sale, or supplying of the product and its use, whether based on warranty, contract, negligence, product liability, or otherwise, shall not exceed the original selling price of the product. The remedies provided herein are the customer’s sole and exclusive remedies. In no event shall Cincoze be liable for direct, indirect, special or consequential damages whether based on contract of any other legal theory.

## Technical Support and Assistance

1. Visit the Cincoze website at [www.cincoze.com](http://www.cincoze.com) where you can find the latest information about the product.
2. Contact your distributor or our technical support team or sales representative for technical support if you need additional assistance. Please have following information ready before you call:
  - Product name and serial number
  - Description of your peripheral attachments
  - Description of your software (operating system, version, application software, etc.)
  - A complete description of the problem
  - The exact wording of any error messages

## Conventions Used in this Manual



### WARNING

This indication alerts operators to an operation that, if not strictly observed, may result in severe injury.



### CAUTION

This indication alerts operators to an operation that, if not strictly observed, may result in safety hazards to personnel or damage to equipment.



### NOTE

This indication provides additional information to complete a task easily.



## Safety Precautions

Before installing and using this device, please note the following precautions.

1. Read these safety instructions carefully.
2. Keep this User's Manual for future reference.
3. Disconnect this equipment from any AC outlet before cleaning.
4. For plug-in equipment, the power outlet socket must be located near the equipment and must be easily accessible.
5. Keep this equipment away from humidity.
6. Put this equipment on a reliable surface during installation. Dropping it or letting it fall may cause damage.
7. Make sure the voltage of the power source is correct before connecting the equipment to the power outlet.
8. Use a power cord that has been approved for using with the product and that it matches the voltage and current marked on the product's electrical range label. The voltage and current rating of the cord must be greater than the voltage and current rating marked on the product.
9. Position the power cord so that people cannot step on it. Do not place anything over the power cord.
10. All cautions and warnings on the equipment should be noted.
11. If the equipment is not used for a long time, disconnect it from the power source to avoid damage by transient overvoltage.
12. Never pour any liquid into an opening. This may cause fire or electrical shock.
13. Never open the equipment. For safety reasons, the equipment should be opened only by qualified service personnel.

If one of the following situations arises, get the equipment checked by service personnel:

- The power cord or plug is damaged.
  - Liquid has penetrated into the equipment.
  - The equipment has been exposed to moisture.
  - The equipment does not work well, or you cannot get it work according to the user's manual.
  - The equipment has been dropped and damaged.
  - The equipment has obvious signs of breakage.
14. CAUTION: Danger of explosion if battery is incorrectly replaced. Replace only with the same or equivalent type recommended by the manufacturer.
  15. Equipment intended only for use in a RESTRICTED ACCESS AREA.
  16. Ensure to connect the power cord of power adapter to a socket-outlet with earthing connection.
  17. Dispose of used battery promptly. Keep away from children. Do not disassemble and do not dispose of in fire.

## Package Contents

Before installation, please ensure all the items listed in the following table are included in the package.

Item	Description	Q'ty
1	CO-100/P1101 Series Panel PC	1
2	DIO Terminal Block Connector (Female)	1
3	Thermal Pad (for CPU Thermal Block)	1
4	Power Terminal Block Connector (Female)	1
5	Screw Pack	1
6	Remote Power On/Off Terminal Block Connector	1

*Note: Notify your sales representative if any of the above items are missing or damaged.*

## Ordering Information

### Available Models

Model No.	Product Description
CO-119C-R10/P1101-E50-R10	19" TFT-LCD SXGA 5:4 Open Frame Display Modular Panel PC with Intel Atom E3950 Quad Core Processor and P-Cap. Touch
CO-119C-R10/P1101-N42-R10	19" TFT-LCD SXGA 5:4 Open Frame Display Modular Panel PC with Intel Pentium N4200 Quad Core Processor and P-Cap. Touch
CO-W121C-R10/P1101-E50-R10	21.5" TFT-LCD Full HD 16:9 Open Frame Display Modular Panel PC with Intel Atom E3950 Quad Core Processor and P-Cap. Touch
CO-W121C-R10/P1101-N42-R10	21.5" TFT-LCD Full HD 16:9 Open Frame Display Modular Panel PC with Intel Pentium N4200 Quad Core Processor and P-Cap. Touch



# **Chapter 1**

## **Product Introductions**

# 1.1 Overview

Cincoze power efficient open frame modular panel PCs (CO-100/P1101 Series) support Intel® Atom® and Pentium® processors, and multiple displays. Native I/O ports include LAN, USB, COM, and DIO, and the series supports CFM technology, offering expansion functions such as Power Ignition Sensing (IGN) to meet different application needs. The integrated structure, exclusive adjustable mounting bracket, and support for various mounting methods enable a perfect fit in cabinets of different materials and thicknesses. The robust design also meets the application needs of harsh industrial environments.

# 1.2 Highlights

## Power Efficient & Multi-Display

Powered by Intel® Atom® or Pentium® processor with support for multiple displays.



## Rich I/O for Flexible Expansion



Native I/O ports include LAN, USB, COM, DIO, Mini-PCIe, and SIM slot, while the whole series supports CFM technology for additional expansion functions like Power Ignition Sensing (IGN) or Power over Ethernet (PoE) to meet different application needs.

## Patented CDS Technology

The patented CDS (Convertible Display System) technology makes maintenance easy and offers flexibility for future upgrades. To upgrade the panel size, replace the display module, or to upgrade the system performance, replace the computer module.

Patent No. M482908

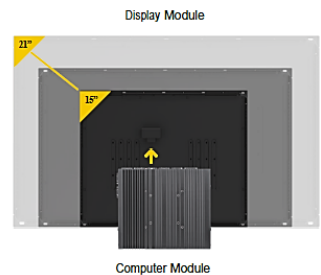



## Flexible Design and Easy Installation

Exclusive adjustable mounting bracket with thickness adjustment setting and two panel-locking methods (panel or boss type) make modular panel PC easier and more convenient to integrate into industrial machinery.

Patent No. I802427, D224544, D224545

## Integrated Structure

As standard, the open frame modular panel pc can be deployed in equipment machines, but remove the mounting bracket and it becomes a standalone panel pc for use with a VESA mount or in a 19" rack.



## Strong, Reliable and Durable

Meets the requirements for HMI applications in harsh industrial environments: IP65 waterproof and dustproof front panel, fanless, wide temperature (0–70°C), and wide voltage (9–48 VDC).

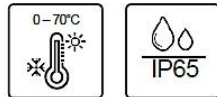

## 1.3 Key Features

- TFT-LCD with Projected Capacitive Touch
- Onboard Intel® Atom® / Pentium® Processor
- 1x DDR3L SO-DIMM max. up to 8GB
- Designed with Adjustable Mounting Bracket
- Support Flat / Standard / VESA / Rack Mount
- Front Panel IP65 Compliant
- Wide Operating Temperature
- Cincoze Patent CDS Technology Support

# 1.4 Hardware Specification

## 1.4.1 CO-119C-R10/P1101 Series

Model Name	CO-119C
<b>Display</b>	
LCD Size	• 19" (5:4)
Resolution	• 1280 x 1024
Brightness	• 350 cd/m <sup>2</sup>
Contract Ratio	• 1000:1
LCD Color	• 16.7M
Pixel Pitch	• 0.294(H) x 0.294(V)
Viewing Angle	• 170 (H) / 160 (V)
Backlight MTBF	• 50,000 hrs (LED Backlight)
<b>Touchscreen</b>	
Touchscreen Type	• Projected Capacitive Touch
<b>Physical</b>	
Dimension (WxDxH)	• 472.8 x 397.5 x 63 mm
Weight	• 6.91KG
Construction	• One-piece and Slim Bezel Design
Mounting Type	• Flat / Standard / VESA / Rack Mount
Mounting Bracket	• Pre-installed Mounting Bracket with Adjustable Design ( Support 11 different stages of adjustment)
<b>Protection</b>	
Ingress Protection	• Front Panel IP65 Compliant * According to IEC60529
<b>Environment</b>	
Operating Temperature	• 0°C to 50°C (with Industrial Grade peripherals; Ambient with air flow)
Storage Temperature	• -20°C to 60°C
Humidity	• 80% RH @ 50°C (non-condensing)
EMC	• CE, UKCA, FCC, ICES-003 Class A
EMI	• CISPR 32 Conducted & Radiated: Class A • EN/BS EN 55032 Conducted & Radiated: Class A • EN/BS EN IEC 61000-3-2 Harmonic current emissions: Class A • EN/BS EN61000-3-3 Voltage fluctuations & flicker • FCC 47 CFR Part 15B, ICES-003 Conducted & Radiated: Class A
EMS	• EN/IEC 61000-4-2 ESD: Contact: 4 kV; Air: 8 kV • EN/IEC 61000-4-3 RS: 80 MHz to 1000 MHz: 3 V/m

	<ul style="list-style-type: none"> <li>• EN/IEC 61000-4-4 EFT: AC Power: 1 kV; DC Power: 0.5 kV; Signal: 0.5 kV</li> <li>• EN/IEC 61000-4-5 Surges: AC Power: 2 kV; Signal: 1 kV</li> <li>• EN/IEC 61000-4-6 CS: 3V</li> <li>• EN/IEC 61000-4-8 PFMF: 50 Hz, 1A/m</li> <li>• EN/IEC 61000-4-11 Voltage Dips &amp; Voltage Interruptions: 0.5 cycles at 50 Hz</li> </ul>
--	---

Model Name	P1101
<b>System</b>	
Processor	<ul style="list-style-type: none"> <li>• Onboard Intel® Atom® x7-E3950 Quad Core Processor, up to 2.00 GHz</li> <li>• Onboard Intel® Pentium® N4200 Quad Core Processor, up to 2.50 GHz</li> </ul>
Memory	<ul style="list-style-type: none"> <li>• 1x DDR3L 1333/1600/1866 MHz 204-Pin SO-DIMM Socket</li> <li>• Support up to 8 GB (un-buffered and non-ECC)</li> </ul>
<b>Graphics</b>	
Graphics Engine	<ul style="list-style-type: none"> <li>• Integrated Intel® HD Graphics 505</li> </ul>
Maximum Display Output	<ul style="list-style-type: none"> <li>• Supports Triple Independent Display (1x CDS, 1x VGA, 1x DisplayPort)</li> </ul>
VGA	<ul style="list-style-type: none"> <li>• 1x VGA Connector(1920x1200@60Hz)</li> </ul>
DP	<ul style="list-style-type: none"> <li>• 1x DisplayPort Connector (4K x 2K @60Hz)</li> </ul>
<b>Audio</b>	
Audio Codec	<ul style="list-style-type: none"> <li>• Realtek® ALC888, High Definition Audio</li> </ul>
Line-out	<ul style="list-style-type: none"> <li>• 1x Line-out, Phone Jack 3.5mm</li> </ul>
Mic-in	<ul style="list-style-type: none"> <li>• 1x Mic-in, Phone Jack 3.5mm</li> </ul>
<b>I/O</b>	
LAN	<ul style="list-style-type: none"> <li>• 2x GbE LAN (Supports WoL, Teaming, Jumbo Frame &amp; PXE), RJ45</li> <li>- GbE1: Intel® I210</li> <li>- GbE2: Intel® I210</li> </ul>
USB	<ul style="list-style-type: none"> <li>• 4x USB 3.2 Gen1 (Type A)</li> </ul>
Serial Port	<ul style="list-style-type: none"> <li>• 4x RS-232/422/485 with Auto Flow Control Support 5V/12V, DB9</li> </ul>
DIO	<ul style="list-style-type: none"> <li>• 8x Digital I/O (4in/4out) , 10-Pin Terminal Block</li> </ul>
Power Mode Switch	<ul style="list-style-type: none"> <li>• 1x AT/ATX Mode Switch</li> </ul>
Power Switch	<ul style="list-style-type: none"> <li>• 1x Power Switch</li> </ul>
Reset Button	<ul style="list-style-type: none"> <li>• 1x Reset Button</li> </ul>
Clear CMOS Switch	<ul style="list-style-type: none"> <li>• 1x Clear CMOS Switch</li> </ul>
Remote Power On/Off	<ul style="list-style-type: none"> <li>• 1x Remote Power On/Off Connector, 2-pin Terminal Block</li> </ul>
<b>Storage</b>	
SSD/HDD	<ul style="list-style-type: none"> <li>• 1x 2.5" SATA HDD Bay (SATA3.0)</li> </ul>
mSATA	<ul style="list-style-type: none"> <li>• 1x mSATA Socket (SATA 3.0, Shared by Mini-PCIe Socket)</li> </ul>
<b>Expansion</b>	
Mini PCI Express	<ul style="list-style-type: none"> <li>• 2x Full-size Mini PCIe Sockets</li> </ul>

SIM Socket	<ul style="list-style-type: none"> <li>• 1 x SIM Socket</li> </ul>
CFM (Control Function Module) Interface	<ul style="list-style-type: none"> <li>• Optional CFM IGN Module for Power Ignition Function</li> <li>• Optional CFM PoE Module for Power over Ethernet Function</li> </ul>
CDS (Convertible Display System) Technology	<ul style="list-style-type: none"> <li>• 1x CDS Interface for Convertible Display Module</li> </ul>
Antenna Holes	<ul style="list-style-type: none"> <li>• 4x Antenna Holes</li> </ul>
<b>Other Function</b>	
Instant Reboot	<ul style="list-style-type: none"> <li>• Support 0.2sec</li> </ul>
Watchdog Timer	<ul style="list-style-type: none"> <li>• Software Programmable Supports 256 Levels System Reset</li> </ul>
Internal Speaker	<ul style="list-style-type: none"> <li>• AMP 2W + 2W</li> </ul>
OSD Function	<ul style="list-style-type: none"> <li>• LCD On/Off, Brightness Up, Brightness Down</li> </ul>
<b>Power</b>	
AT/ATX Power	<ul style="list-style-type: none"> <li>• Support AT, ATX Mode</li> </ul>
Power Input	<ul style="list-style-type: none"> <li>• 1x 3-pin Terminal Block Connector with Power Input 9-48VDC</li> </ul>
Power Adapter (Optional)	<ul style="list-style-type: none"> <li>• 1x Optional AC/DC 12V/5A, 60W or 24V/5A 120W</li> </ul>
<b>Physical</b>	
Dimension( W x D x H )	<ul style="list-style-type: none"> <li>• 204.5 X 149 X 41.5 mm</li> </ul>
Weight Information	<ul style="list-style-type: none"> <li>• 1.49kg</li> </ul>
Mechanical Construction	<ul style="list-style-type: none"> <li>• Extruded Aluminum with Heavy Duty Metal</li> </ul>
Mounting	<ul style="list-style-type: none"> <li>• Wall / VESA / CDS / DIN Rail</li> </ul>
<b>Reliability &amp; Protection</b>	
Reverse Power Input	<ul style="list-style-type: none"> <li>• Yes</li> </ul>
Over Voltage Protection	<ul style="list-style-type: none"> <li>• Protection Range: 51-58V</li> <li>• Protection Type: shut down operating voltage,</li> <li>• re-power on at the present level to recover</li> </ul>
Over Current Protection	<ul style="list-style-type: none"> <li>• 15A</li> </ul>
CMOS Battery Backup	<ul style="list-style-type: none"> <li>• SuperCap Integrated for CMOS Battery Maintenance-free Operation</li> </ul>
MTBF	<ul style="list-style-type: none"> <li>• Time: 294,617 hours</li> </ul>
<b>Operating System</b>	
Microsoft® Windows®	<ul style="list-style-type: none"> <li>• Windows®10</li> </ul>
Linux	<ul style="list-style-type: none"> <li>• Supports by project</li> </ul>
<b>Environment</b>	
Operating Temperature	<ul style="list-style-type: none"> <li>• Ambient with Air Flow: -40°C to 70°C (with Industrial Grade Peripherals)</li> </ul>
Storage Temperature	<ul style="list-style-type: none"> <li>• -40°C to 85°C</li> </ul>
Relative humidity	<ul style="list-style-type: none"> <li>• 90% RH @ 75°C (non-condensing)</li> </ul>
Shock	<ul style="list-style-type: none"> <li>• Operating, 50 Grms, Half-sine 11 ms Duration (w/ SSD, according to IEC60068-2-27)</li> </ul>
Vibration	<ul style="list-style-type: none"> <li>• Operating, 5 Grms, 5-500 Hz, 3 Axes (w/ SSD, according to IEC60068-2-64)</li> </ul>



EMC	<ul style="list-style-type: none"> <li>• CE, UKCA, FCC, ICES-003 Class A</li> </ul>
EMI	<ul style="list-style-type: none"> <li>• CISPR 32 Conducted &amp; Radiated: Class A</li> <li>• EN/BS EN 55032 Conducted &amp; Radiated: Class A</li> <li>• EN/BS EN IEC 61000-3-2 Harmonic current emissions: Class A</li> <li>• EN/BS EN61000-3-3 Voltage fluctuations &amp; flicker</li> <li>• FCC 47 CFR Part 15B, ICES-003 Conducted &amp; Radiated: Class A</li> </ul>
EMS	<ul style="list-style-type: none"> <li>• EN/IEC 61000-4-2 ESD: Contact: 4 kV; Air: 8 kV</li> <li>• EN/IEC 61000-4-3 RS: 80 MHz to 1000 MHz: 3 V/m</li> <li>• EN/IEC 61000-4-4 EFT: AC Power: 1 kV; DC Power: 0.5 kV; Signal: 0.5 kV</li> <li>• EN/IEC 61000-4-5 Surges: AC Power: 2 kV; Signal: 1 kV</li> <li>• EN/IEC 61000-4-6 CS: 3V</li> <li>• EN/IEC 61000-4-8 PFMF: 50 Hz, 1A/m</li> <li>• EN/IEC 61000-4-11 Voltage Dips &amp; Voltage Interruptions: 0.5 cycles at 50 Hz</li> </ul>
Safety	<ul style="list-style-type: none"> <li>• LVD IEC/EN 62368-1</li> </ul>

*\* Product Specifications and features are for reference only and are subject to change without prior notice. For more information, please refer to the latest product datasheet from Cincoze's website.*

## Dimension

CO-119C/P1101

Unit: mm

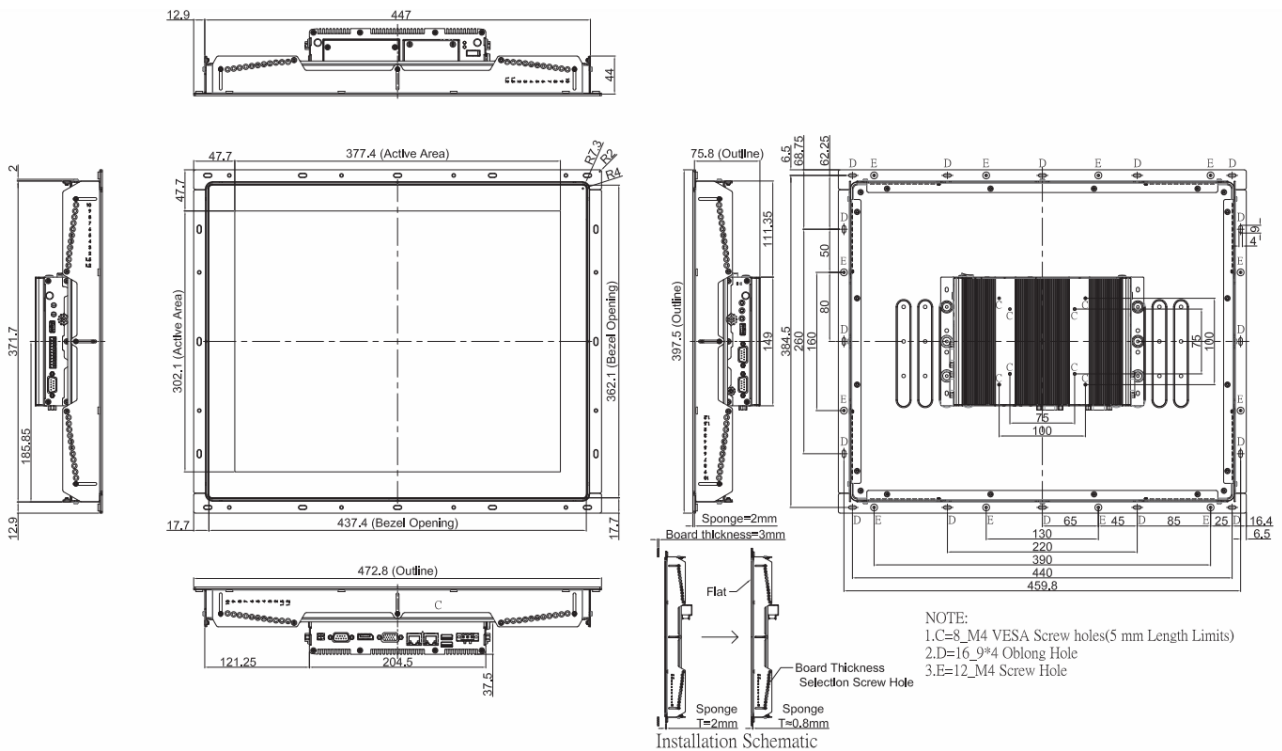

## 1.4.2 CO-W121C-R10/P1101 Series

Model Name	CO-W121C
<b>Display</b>	
LCD Size	• 21.5" (16:9)
Resolution	• 1920 x 1080
Brightness	• 300 cd/m <sup>2</sup>
Contract Ratio	• 5000:1
LCD Color	• 16.7M
Pixel Pitch	• 0.24825(H) x 0.24825(V) mm
Viewing Angle	• 178 (H) / 178 (V)
Backlight MTBF	• 50,000 hrs
<b>Touchscreen</b>	
Touchscreen Type	• Projected Capacitive Touch
<b>Physical</b>	
Dimension (WxDxH)	• 550 x 343.7 x 63.3
Weight	• 7.16KG
Construction	• One-piece and Slim Bezel Design
Mounting Type	• Flat / Standard / VESA / Rack Mount
Mounting Bracket	• Pre-installed Mounting Bracket with Adjustable Design ( Support 11 different stages of adjustment)
<b>Protection</b>	
Ingress Protection	• Front Panel IP65 Compliant * According to IEC60529
<b>Environment</b>	
Operating Temperature	• 0°C to 60°C (with Industrial Grade peripherals; Ambient with air flow)
Storage Temperature	• -20°C to 60°C
Humidity	• 80% RH @ 50°C (non-condensing)
EMC	• CE, UKCA, FCC, ICES-003 Class A
EMI	• CISPR 32 Conducted & Radiated: Class A • EN/BS EN 55032 Conducted & Radiated: Class A • EN/BS EN IEC 61000-3-2 Harmonic current emissions: Class A • EN/BS EN61000-3-3 Voltage fluctuations & flicker • FCC 47 CFR Part 15B, ICES-003 Conducted & Radiated: Class A
EMS	• EN/IEC 61000-4-2 ESD: Contact: 4 kV; Air: 8 kV • EN/IEC 61000-4-3 RS: 80 MHz to 1000 MHz: 3 V/m • EN/IEC 61000-4-4 EFT: AC Power: 1 kV; DC Power: 0.5 kV; Signal: 0.5 kV • EN/IEC 61000-4-5 Surges: AC Power: 2 kV; Signal: 1 kV

	<ul style="list-style-type: none"> <li>• EN/IEC 61000-4-6 CS: 3V</li> <li>• EN/IEC 61000-4-8 PFMF: 50 Hz, 1A/mEN/IEC 61000-4-11 Voltage Dips &amp; Voltage Interruptions: 0.5 cycles at 50 Hz</li> </ul>
Safety	<ul style="list-style-type: none"> <li>• UL, cUL, CB, IEC, EN 62368-1</li> </ul>

Model Name	P1101
<b>System</b>	
Processor	<ul style="list-style-type: none"> <li>• Onboard Intel® Atom® x7-E3950 Quad Core Processor, up to 2.00 GHz</li> <li>• Onboard Intel® Pentium® N4200 Quad Core Processor, up to 2.50 GHz</li> </ul>
Memory	<ul style="list-style-type: none"> <li>• 1x DDR3L 1333/1600/1866 MHz 204-Pin SO-DIMM Socket</li> <li>• Support up to 8 GB (un-buffered and non-ECC)</li> </ul>
<b>Graphics</b>	
Graphics Engine	<ul style="list-style-type: none"> <li>• Integrated Intel® HD Graphics 505</li> </ul>
Maximum Display Output	<ul style="list-style-type: none"> <li>• Supports Triple Independent Display (1x CDS, 1x VGA, 1x DisplayPort)</li> </ul>
VGA	<ul style="list-style-type: none"> <li>• 1x VGA Connector(1920x1200@60Hz)</li> </ul>
DP	<ul style="list-style-type: none"> <li>• 1x DisplayPort Connector (4K x 2K @60Hz)</li> </ul>
<b>Audio</b>	
Audio Codec	<ul style="list-style-type: none"> <li>• Realtek® ALC888, High Definition Audio</li> </ul>
Line-out	<ul style="list-style-type: none"> <li>• 1x Line-out, Phone Jack 3.5mm</li> </ul>
Mic-in	<ul style="list-style-type: none"> <li>• 1x Mic-in, Phone Jack 3.5mm</li> </ul>
<b>I/O</b>	
LAN	<ul style="list-style-type: none"> <li>• 2x GbE LAN (Supports WoL, Teaming, Jumbo Frame &amp; PXE), RJ45</li> <li>- GbE1: Intel® I210</li> <li>- GbE2: Intel® I210</li> </ul>
USB	<ul style="list-style-type: none"> <li>• 4x USB 3.2 Gen1 (Type A)</li> </ul>
Serial Port	<ul style="list-style-type: none"> <li>• 4x RS-232/422/485 with Auto Flow Control Support 5V/12V, DB9</li> </ul>
DIO	<ul style="list-style-type: none"> <li>• 8x Digital I/O (4in/4out) , 10-Pin Terminal Block</li> </ul>
Power Mode Switch	<ul style="list-style-type: none"> <li>• 1x AT/ATX Mode Switch</li> </ul>
Power Switch	<ul style="list-style-type: none"> <li>• 1x Power Switch</li> </ul>
Reset Button	<ul style="list-style-type: none"> <li>• 1x Reset Button</li> </ul>
Clear CMOS Switch	<ul style="list-style-type: none"> <li>• 1x Clear CMOS Switch</li> </ul>
Remote Power On/Off	<ul style="list-style-type: none"> <li>• 1x Remote Power On/Off Connector, 2-pin Terminal Block</li> </ul>
<b>Storage</b>	
SSD/HDD	<ul style="list-style-type: none"> <li>• 1x 2.5" SATA HDD Bay (SATA3.0)</li> </ul>
mSATA	<ul style="list-style-type: none"> <li>• 1x mSATA Socket (SATA 3.0, Shared by Mini-PCIe Socket)</li> </ul>
<b>Expansion</b>	
Mini PCI Express	<ul style="list-style-type: none"> <li>• 2x Full-size Mini PCIe Sockets</li> </ul>
SIM Socket	<ul style="list-style-type: none"> <li>• 1 x SIM Socket</li> </ul>

CFM (Control Function Module) Interface	<ul style="list-style-type: none"> <li>• Optional CFM IGN Module for Power Ignition Function</li> <li>• Optional CFM PoE Module for Power over Ethernet Function</li> </ul>
CDS (Convertible Display System) Technology	<ul style="list-style-type: none"> <li>• 1x CDS Interface for Convertible Display Module</li> </ul>
Antenna Holes	<ul style="list-style-type: none"> <li>• 4x Antenna Holes</li> </ul>
<b>Other Function</b>	
Instant Reboot	<ul style="list-style-type: none"> <li>• Support 0.2sec</li> </ul>
Watchdog Timer	<ul style="list-style-type: none"> <li>• Software Programmable Supports 256 Levels System Reset</li> </ul>
Internal Speaker	<ul style="list-style-type: none"> <li>• AMP 2W + 2W</li> </ul>
OSD Function	<ul style="list-style-type: none"> <li>• LCD On/Off, Brightness Up, Brightness Down</li> </ul>
<b>Power</b>	
AT/ATX Power	<ul style="list-style-type: none"> <li>• Support AT, ATX Mode</li> </ul>
Power Input	<ul style="list-style-type: none"> <li>• 1x 3-pin Terminal Block Connector with Power Input 9-48VDC</li> </ul>
Power Adapter (Optional)	<ul style="list-style-type: none"> <li>• 1x Optional AC/DC 12V/5A, 60W or 24V/5A 120W</li> </ul>
<b>Physical</b>	
Dimension( W x D x H )	<ul style="list-style-type: none"> <li>• 204.5 X 149 X 41.5 mm</li> </ul>
Weight Information	<ul style="list-style-type: none"> <li>• 1.49kg</li> </ul>
Mechanical Construction	<ul style="list-style-type: none"> <li>• Extruded Aluminum with Heavy Duty Metal</li> </ul>
Mounting	<ul style="list-style-type: none"> <li>• Wall / VESA / CDS / DIN Rail</li> </ul>
<b>Reliability &amp; Protection</b>	
Reverse Power Input	<ul style="list-style-type: none"> <li>• Yes</li> </ul>
Over Voltage Protection	<ul style="list-style-type: none"> <li>• Protection Range: 51-58V</li> <li>• Protection Type: shut down operating voltage, re-power on at the present level to recover</li> </ul>
Over Current Protection	<ul style="list-style-type: none"> <li>• 15A</li> </ul>
CMOS Battery Backup	<ul style="list-style-type: none"> <li>• SuperCap Integrated for CMOS Battery Maintenance-free Operation</li> </ul>
MTBF	<ul style="list-style-type: none"> <li>• Time: 294,617 hours</li> </ul>
<b>Operating System</b>	
Microsoft® Windows®	<ul style="list-style-type: none"> <li>• Windows®10</li> </ul>
Linux	<ul style="list-style-type: none"> <li>• Supports by project</li> </ul>
<b>Environment</b>	
Operating Temperature	<ul style="list-style-type: none"> <li>• Ambient with Air Flow: -40°C to 70°C (with Industrial Grade Peripherals)</li> </ul>
Storage Temperature	<ul style="list-style-type: none"> <li>• -40°C to 85°C</li> </ul>
Relative humidity	<ul style="list-style-type: none"> <li>• 90% RH @ 75°C (non-condensing)</li> </ul>
Shock	<ul style="list-style-type: none"> <li>• Operating, 50 Grms, Half-sine 11 ms Duration (w/ SSD, according to IEC60068-2-27)</li> </ul>
Vibration	<ul style="list-style-type: none"> <li>• Operating, 5 Grms, 5-500 Hz, 3 Axes (w/ SSD, according to IEC60068-2-64)</li> </ul>
EMC	<ul style="list-style-type: none"> <li>• CE, UKCA, FCC, ICES-003 Class A</li> </ul>

EMI	<ul style="list-style-type: none"> <li>• CISPR 32 Conducted &amp; Radiated: Class A</li> <li>• EN/BS EN 55032 Conducted &amp; Radiated: Class A</li> <li>• EN/BS EN IEC 61000-3-2 Harmonic current emissions: Class A</li> <li>• EN/BS EN61000-3-3 Voltage fluctuations &amp; flicker</li> <li>• FCC 47 CFR Part 15B, ICES-003 Conducted &amp; Radiated: Class A</li> </ul>
EMS	<ul style="list-style-type: none"> <li>• EN/IEC 61000-4-2 ESD: Contact: 4 kV; Air: 8 kV</li> <li>• EN/IEC 61000-4-3 RS: 80 MHz to 1000 MHz: 3 V/m</li> <li>• EN/IEC 61000-4-4 EFT: AC Power: 1 kV; DC Power: 0.5 kV; Signal: 0.5 kV</li> <li>• EN/IEC 61000-4-5 Surges: AC Power: 2 kV; Signal: 1 kV</li> <li>• EN/IEC 61000-4-6 CS: 3V</li> <li>• EN/IEC 61000-4-8 PFMF: 50 Hz, 1A/m</li> <li>• EN/IEC 61000-4-11 Voltage Dips &amp; Voltage Interruptions: 0.5 cycles at 50 Hz</li> </ul>
Safety	<ul style="list-style-type: none"> <li>• LVD IEC/EN 62368-1</li> </ul>

*\* Product Specifications and features are for reference only and are subject to change without prior notice. For more information, please refer to the latest product datasheet from Cincoze's website.*

## Dimension

CO-W121C/P1101

Unit: mm

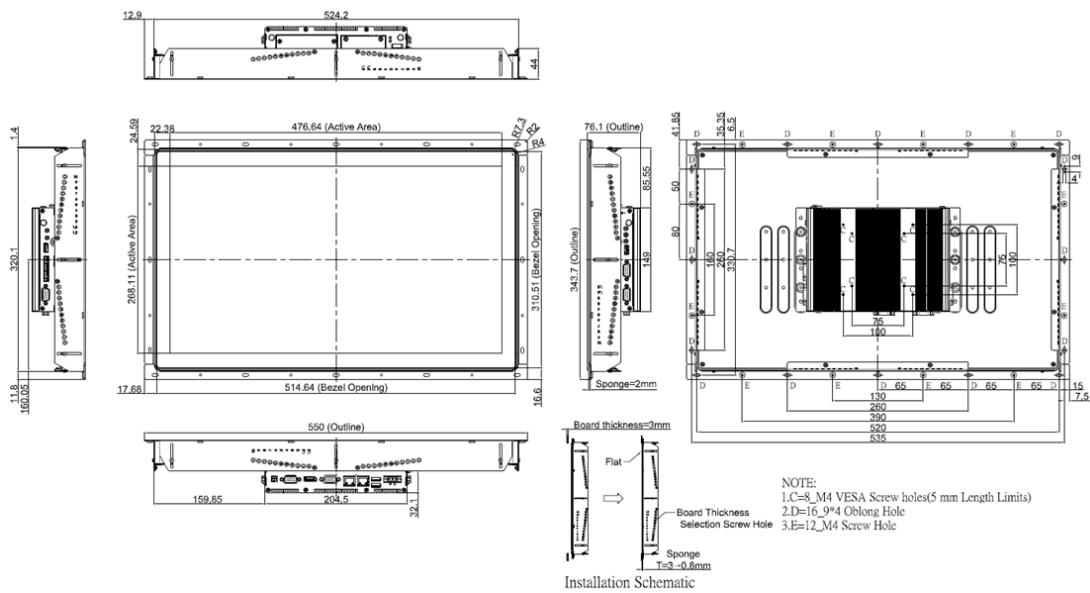

# 1.5 System I/O

## 1.5.1 Front

### Antenna

Used to install an antenna jack

### SIM Card

Used to inserts a SIM card

### AT/ATX Switch

Used to select AT or ATX power mode

### Power LED

Indicates the power status of the system

### HDD LED

Indicates the status of the hard drive

### Removable HDD

Used to inserts a 2.5" HDD/SSD

### Power On/Off Switch

Press to power-on or power-off the system

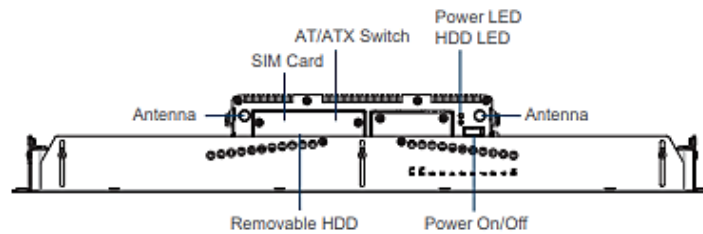

## 1.5.2 Rear

### DC IN

Used to plug a DC power input with terminal block

### USB 3.0

Used to connect USB 3.0/2.0 device

### LAN1, LAN2

Used to connect the system to a local area network

### VGA

Used to connect an analog VGA monitor

### Display Port

Used to connect the system with DisplayPort monitor

### COM1

COM1 supports RS232/422/485 serial device

### Remote Power On/Off

Used to plug a remote power on/off terminal block

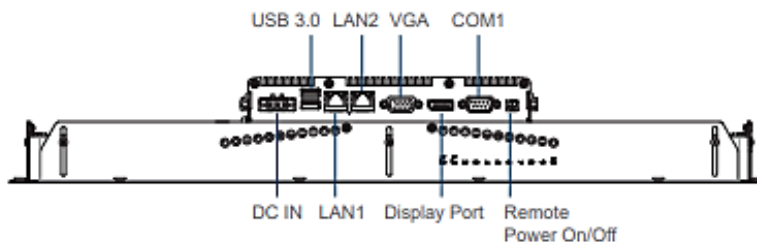

### 1.5.3 Left

#### Temperature LED

Indicates the temperature of the system

#### Reset

Used to reset the system

#### Antenna

Used to install an antenna jack

#### Increase Brightness

Press to increase brightness of the screen

#### Decrease Brightness

Press to decrease brightness of the screen

#### LCD On/Off

Press to turn-on or turn-off the display

#### USB 3.0

Used to connect USB 3.0/2.00 device

#### COM3, COM4

COM3, COM4 support RS232/422/485 serial device

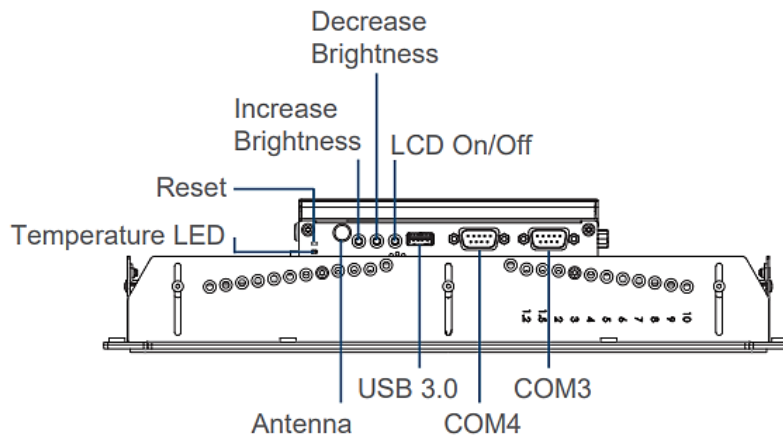

### 1.5.4 Right

#### COM2

COM2 supports RS232/422/485 serial device

#### Digital I/O

The Digital I/O terminal block supports 4 digital input and 4 digital output

#### USB 3.0

Used to connect USB 3.0/2.0 device

#### Mic-In

Used to connect a microphone

#### Line-Out

Used to connect a speaker

#### Antenna

Used to install an antenna jack

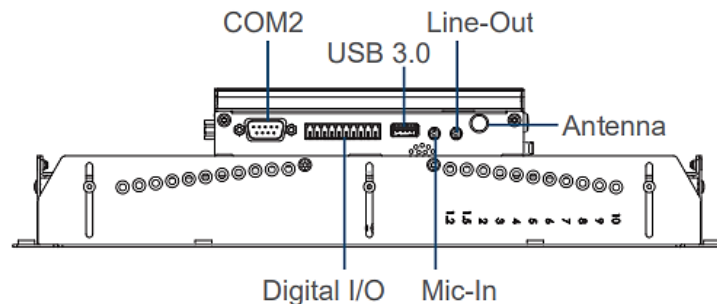



# **Chapter 2**

## **Switches & Connectors**



## 2.1 Location of Switches and Connectors

### 2.1.1 Top View

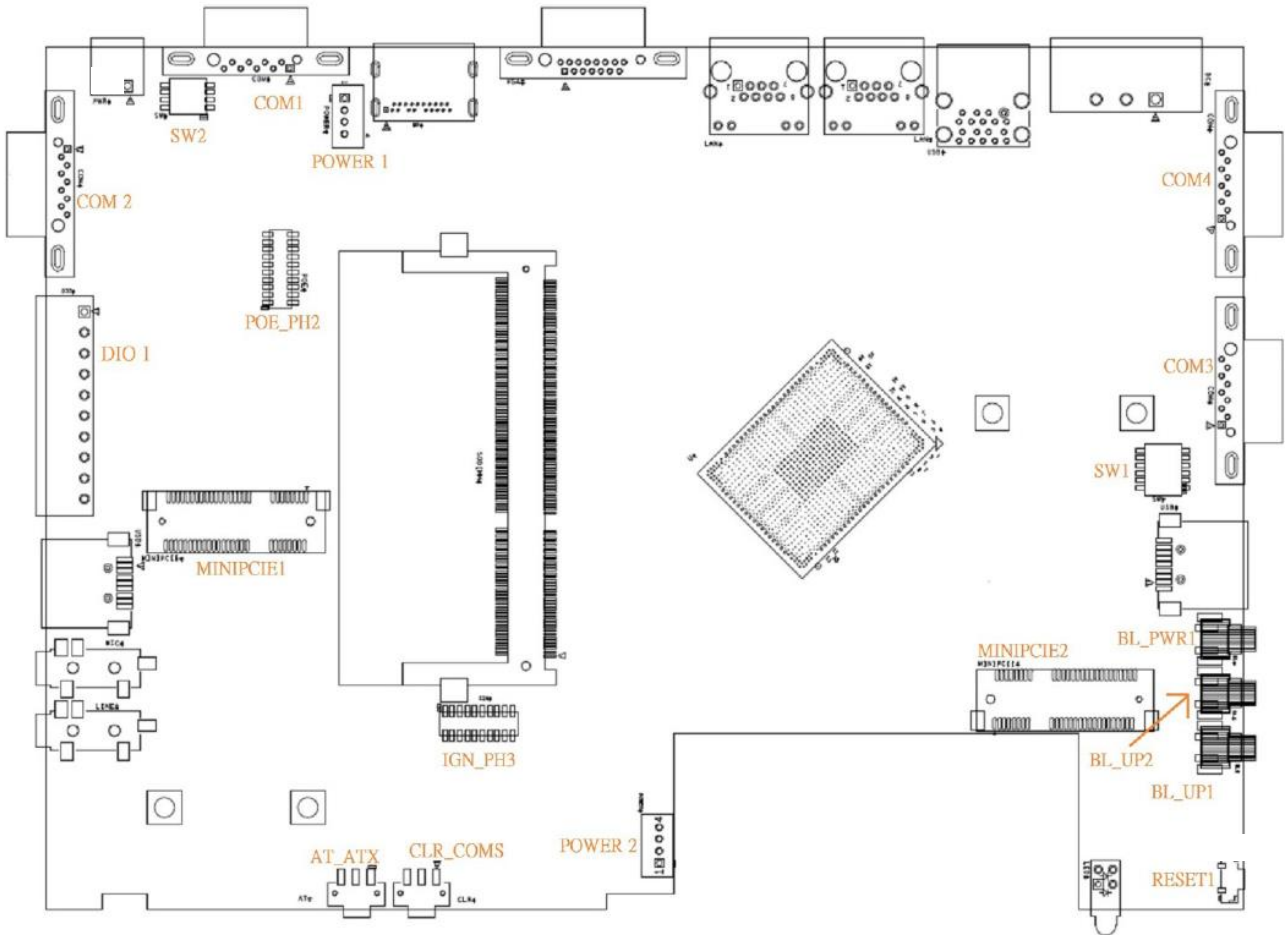

## 2.1.2 Bottom View

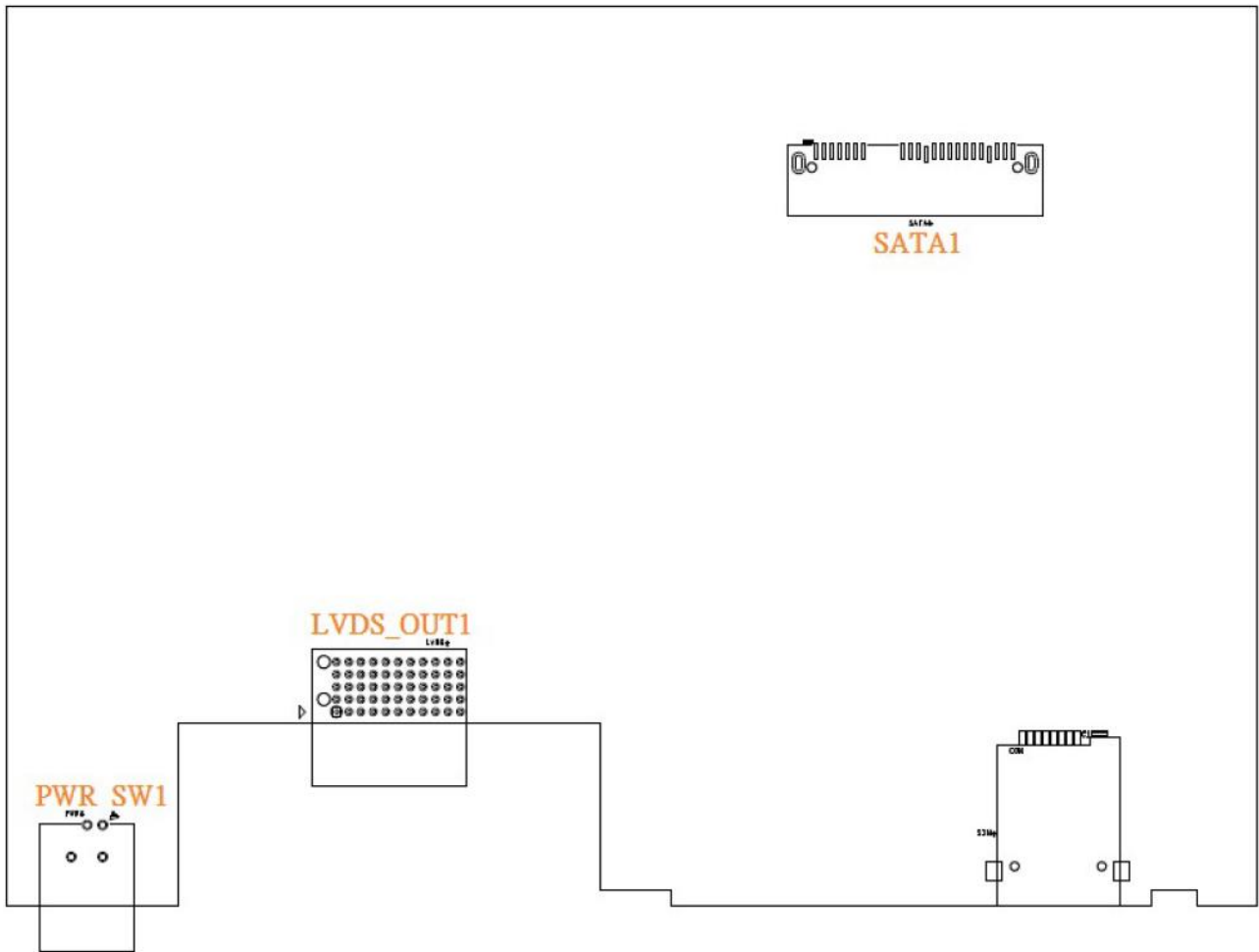

## 2.2 Switches and Connectors Definition

### List of Switches & Connectors

Location	Definition
AT_ATX	AT / ATX Power Mode Switch
CLR_CMOS	Clear CMOS Switch
RESET1	Reset Button
BL_UP1	Backlight Increase Button
BL_UP2	Backlight Decrease Button
BL_PWR1	Backlight Power On / Off Button
USB3_1 / USB3_2 / USB3_3	USB 3.0 Ports
COM1_1 / COM2_1 / COM3_1 / COM4_1	RS232 / RS422 / RS485 Connector
DC_IN1	3-pin DC 9~48V Power Input with Power Ignition Connector
LAN1	LAN Connector
LAN2	LAN Connector
VGA1	VGA Connector
DP1	DisplayPort Connector
PWR_SW2	Power Switch Connector
DIO1	4DI / 4DO Connector
MIC_IN1	Mic-in Jack
LINE_OUT1	Line-Out Jack
SW1	Super CAP SW / COM3~4 with Power Select
SW2	COM1~2 with Power Select
MINIPCIE1	Mini PCI-Express / SIM (USB3) Socket
MINIPCIE2	Mini PCI-Express / mSATA Socket
Power1 / Power2	+5V / +12V Power Output
POE_PH2	POE Board to Board Connector
IGN_PH3	IGN Board to Board Connector
PWR_SW1	Power Switch
LVDS_OUT1	LVDS Connector
SATA1	SATA with Power Connector

## 2.3 Definition of Switches

### AT\_ATX: AT / ATX Power Mode Switch

Switch	Definition
1-2 (Left)	AT Power Mode
2-3 (Right)	ATX Power Mode (Default)

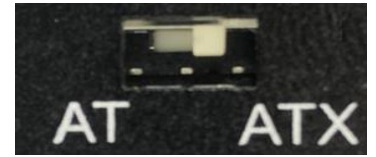

### CLR\_CMOS: Clear CMOS Switch

Switch	Definition
1-2 (Left)	Normal Status (Default)
2-3 (Right)	Clear CMOS

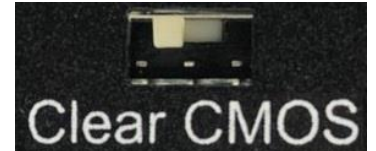

### BL\_PWR1: Backlight Power on / off

Switch	Definition
Push	Backlight Power on / off switching



### BL\_UP1: Backlight Increase

Switch	Definition
Push	Backlight Increase



### BL\_UP2: Backlight Decrease

Switch	Definition
Push	Backlight Decrease



### RESET1: Reset Button

Switch	Definition
Push	Reset System



**SW1: Super CAP SW / COM3~4 with Power Select**

Location	Function		DIP1	DIP2
SW1	Super Cap	Enabled	ON (Default)	N/A
		Disabled	OFF	N/A
Location	Function		DIP3	DIP4
SW1	COM3	0V (RI)	ON (Default)	ON (Default)
		5V	ON	OFF
		12V	OFF	OFF
Location	Function		DIP5	DIP6
SW1	COM4	0V (RI)	ON (Default)	ON (Default)
		5V	ON	OFF
		12V	OFF	OFF

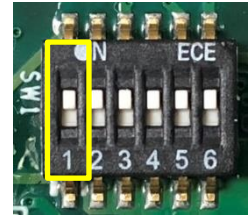

ON  
OFF

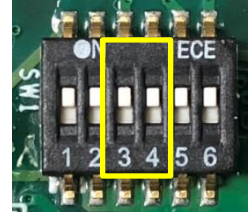

ON  
OFF

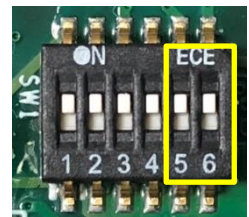

ON  
OFF

**SW2: COM1~2 with Power Select**

Location	Function		DIP1	DIP2
SW2	COM1	0V (RI)	ON (Default)	ON (Default)
		5V	ON	OFF
		12V	OFF	OFF

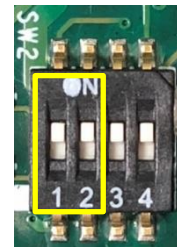

ON  
OFF

Location	Function		DIP3	DIP4
SW2	COM2	0V (RI)	ON (Default)	ON (Default)
		5V	ON	OFF
		12V	OFF	OFF

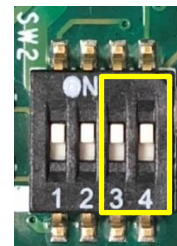

ON  
OFF

**LED1: Power / HDD Access LED Status**

LED	LED Color	Status
POWER	Green	POWER ON
HDD	Blinking Yellow	HDD Read/Write

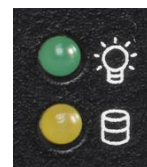

## 2.4 Definition of Connectors

### MINIPCIE1 : Mini PCI-Express Socket (Support SIM Card to Link feature)

Pin	Definition	Pin	Definition	Pin	Definition
1	WAKE#	19	NA	37	RESERVED
2	3.3V	20	3.3V	38	USB_D+
3	NA	21	GND	39	RESERVED
4	GND	22	PERST#	40	GND
5	NA	23	PERNO (USB3RNO) / SATARPO	41	3.3V
6	1.5V	24	3.3V	42	NA
7	CLKREQ#	25	PERPO (USB3RPO) / SATARNO	43	GND
8	SIM_VCC	26	GND	44	NA
9	GND	27	GND	45	NA
10	SIM_DATA	28	+1.5V	46	NA
11	REFCLK-	29	GND	47	NA
12	SIM_CLK	30	SMB_CLK	48	+1.5V
13	REFCLK+	31	PETNO (USB3TNO) / SATATNO	49	NA
14	SIM_Reset	32	SMB_DATA	50	GND
15	GND	33	PETPO (USB3TPO) / SATATPO	51	NA
16	SIM_VPP	34	GND	52	+3.3V
17	NA	35	GND		
18	GND	36	USB_D-		

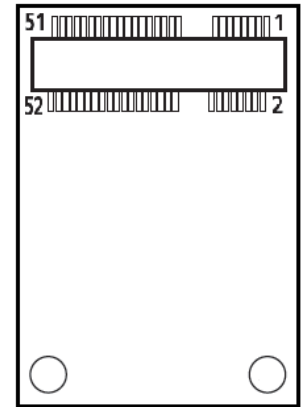

### MINIPCIE2 : Mini PCI-Express Socket (Support mSATA feature)

Pin	Definition	Pin	Definition	Pin	Definition
1	WAKE#	19	NA	37	GND
2	3.3V	20	3.3V	38	USB_D+
3	NA	21	GND	39	3.3V
4	GND	22	PERST#	40	GND
5	NA	23	PERNO / SATARPO	41	3.3V
6	1.5V	24	+3.3VAUX	42	NA
7	CLKREQ#	25	PERPO / SATARNO	43	GND
8	NA	26	GND	44	NA
9	GND	27	GND	45	NA
10	NA	28	+1.5V	46	NA
11	REFCLK-	29	GND	47	NA
12	NA	30	SMB_CLK	48	+1.5V
13	REFCLK+	31	PETNO / ATATNO	49	NA
14	NA	32	SMB_DATA	50	GND
15	GND	33	PETPO / SATATPO	51	NA
16	NA	34	GND	52	+3.3V
17	NA	35	GND		
18	GND	36	USB_D-		

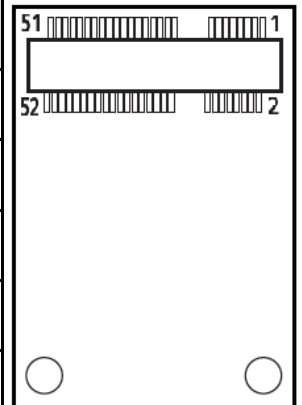

### PWR\_SW2: Remote Power On/Off Connector

Pin	Definition
1	GND
2	PWR_SW

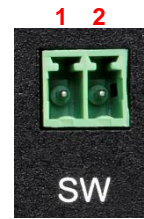

**WARNING**

**Do not apply power to this connector!  
This port is used to connect a SWITCH!**

### DC\_IN1: DC Power Input Connector (+9~48V)

Connector Type: Terminal Block 1x3 3-pin, 5.0mm pitch

Pin	Definition
1	+9~48V IN
2	Ignition (IGN)
3	GND

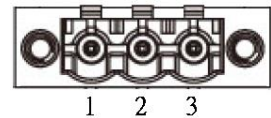

**CAUTION**

**Please disconnect the power source before mounting the DC power cables or connecting the DC power connector to system.**

### LAN1 / LAN2: LAN LED Status Definition

Act LED Status	Definition
Blinking Yellow	Data Activity
Off	No Activity

Link LED Status	Definition
Steady Green	1Gbps Network Link
Steady Orange	100Mbps Network Link
Off	10Mbps Network Link

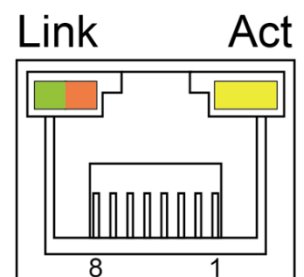



### COM1\_1 / COM2\_1 / COM3\_1 / COM4\_1: RS232 / RS422 / RS485 Connector

Connector Type: 9-pin D-Sub

Pin	RS232 Definition	RS422 / 485 Full Duplex Definition	RS485 Half Duplex Definition
1	DCD	TX-	DATA -
2	RXD	TX+	DATA +
3	TXD	RX+	
4	DTR	RX-	
5	GND		
6	DSR		
7	RTS		
8	CTS		
9	RI		

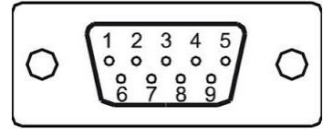



Power over Serial PIN Definitions			
Pin	RS232	RS422/485	RS485
5	GND	GND	GND
9	0/5/12V	0/5/12V	0/5/12V

### POWER1/ POWER2: Power Connector

Connector Type: 1x4 4-pin Wafer, 2.0mm pitch

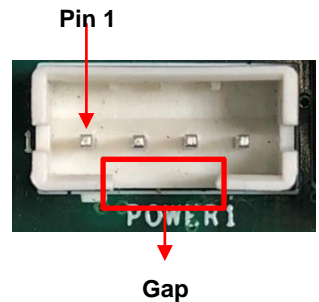
Pin	Definition
1	+5V
2	GND
3	GND
4	+12V





# **Chapter 3**

## **System Setup**

## 3.1 Removing Top Cover



### WARNING

In order to prevent electric shock or system damage, before removing the chassis cover, must turn off power and disconnect the unit from power source.

1. Loosen the 8 screws of front and rear panel, then place them aside.

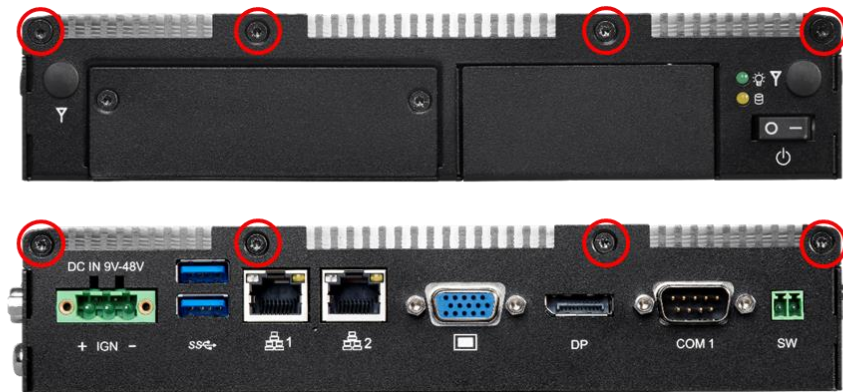

2. Remove the cover from the chassis.



3. Place the top cover gently.

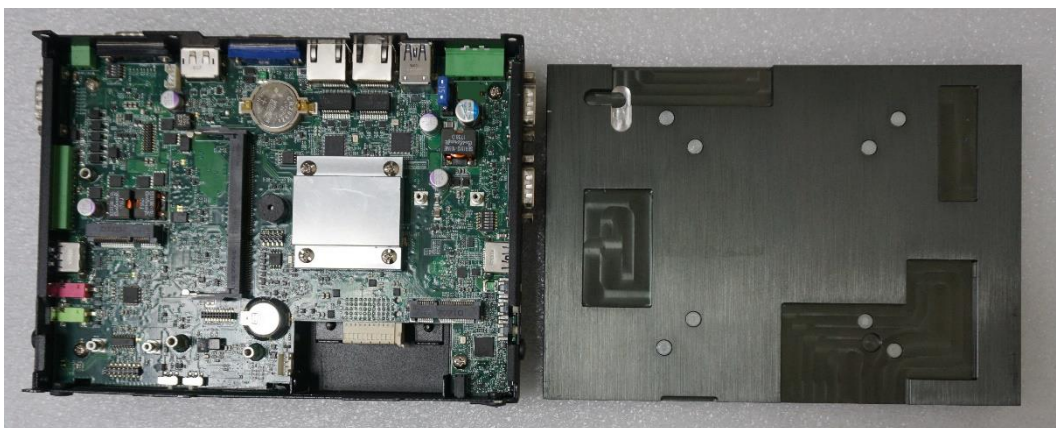

## 3.2 Installing SO-DIMM Memory

1. Locate the SO-DIMM sockets.

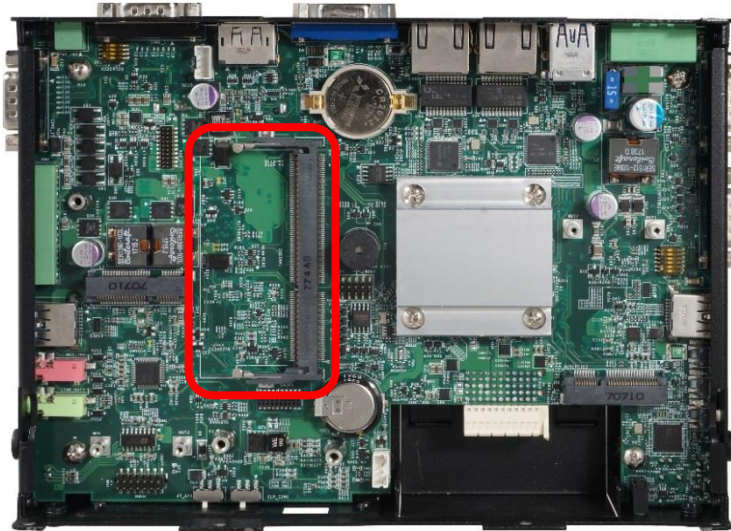

2. Tilt the SO-DIMM module at a 45-degree angle and insert it to SO-DIMM socket until the gold-pated connector of module contacted firmly with the socket.

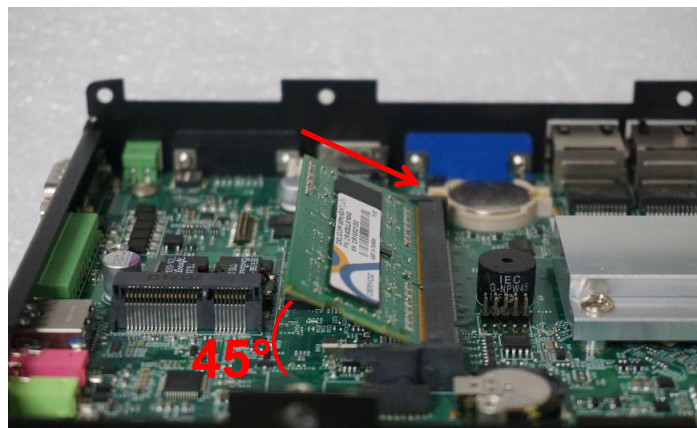

3. Press the modules down until it's fixed firmly by the two locking latches on each side.

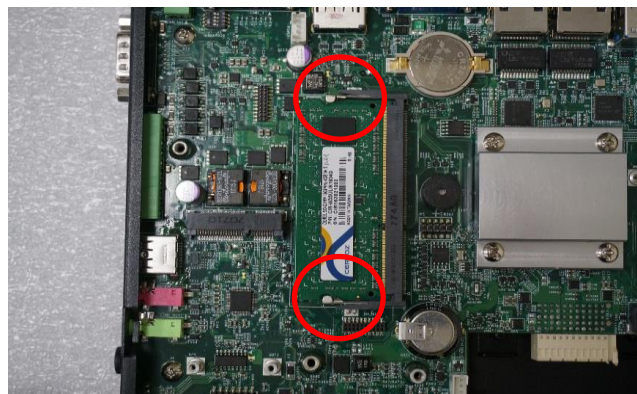

### 3.3 Installing Mini-PCle Card

(Applicable for full or half size card)

1. Locate the Mini PCIe slot.

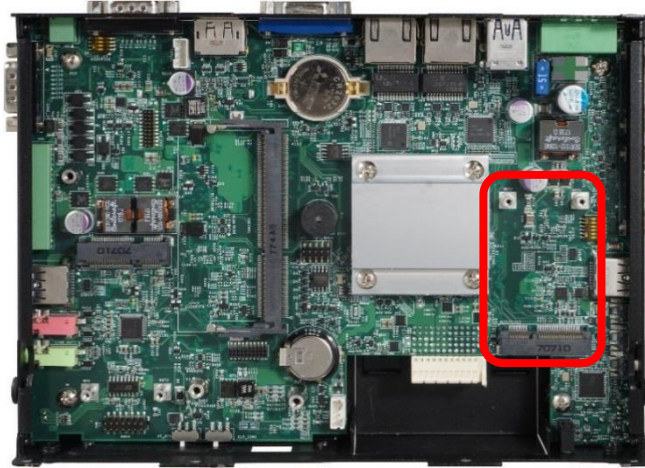

2. Insert the Mini-PCle card at a 45-degree angle and insert it to the slot until the gold-pated connector of module contacted firmly with the slot.

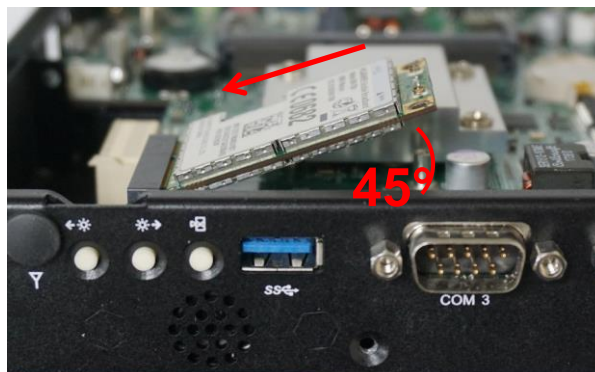

3. Press down the module and fasten two screws to secure the module.

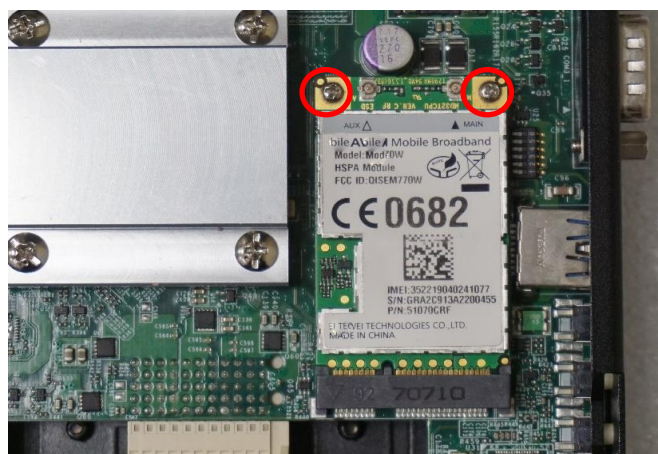

4. If you have a Half-size Mini-PCIe card, make sure use extender to make it Full-size as shown below.

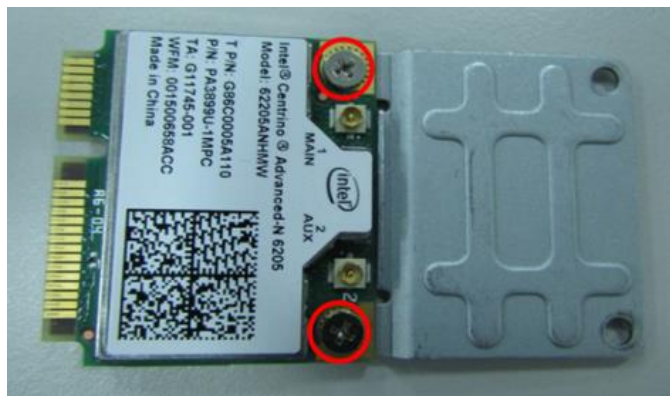

### 3.4 Installing Antenna(s)



**CAUTION**

Please installing a Mini PCIe Wireless Lan Card on top side before you put on washer and fasten the nut with antenna jack.

1. Remove the antenna hole covers at front panel.



2. Have antenna jack penetrate through the hole.

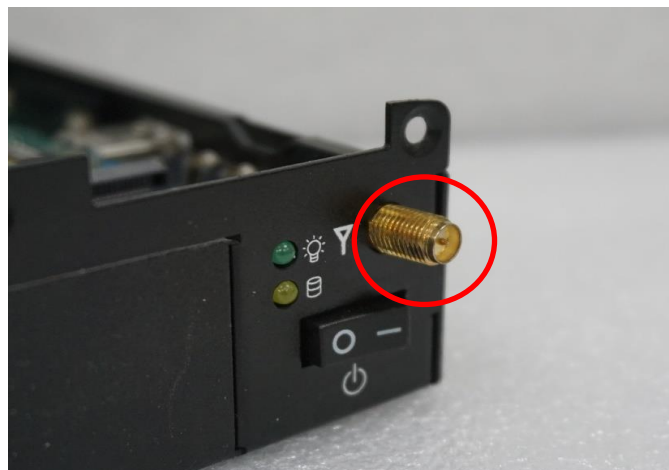

3. Put on washer and fasten the nut with antenna jack.



4. Assemble the antenna and antenna jack together.



5. Attach the RF connector at another end of cable onto the module.

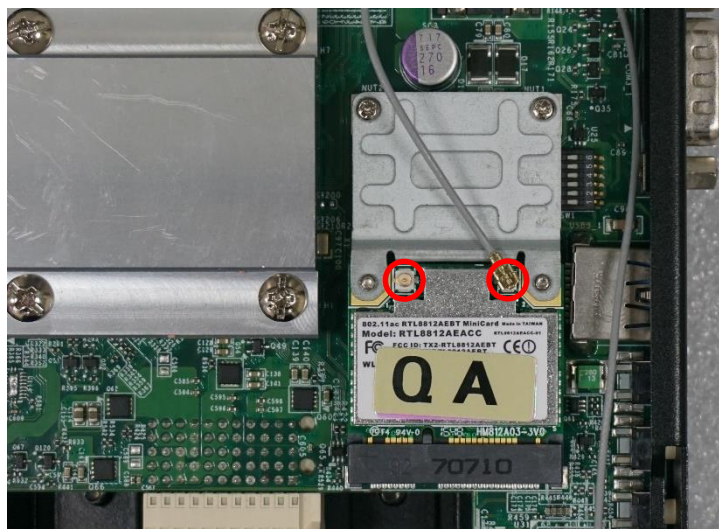

## 3.5 Installing CPU Thermal Pad

1. Place the thermal pad on the CPU heatsink.

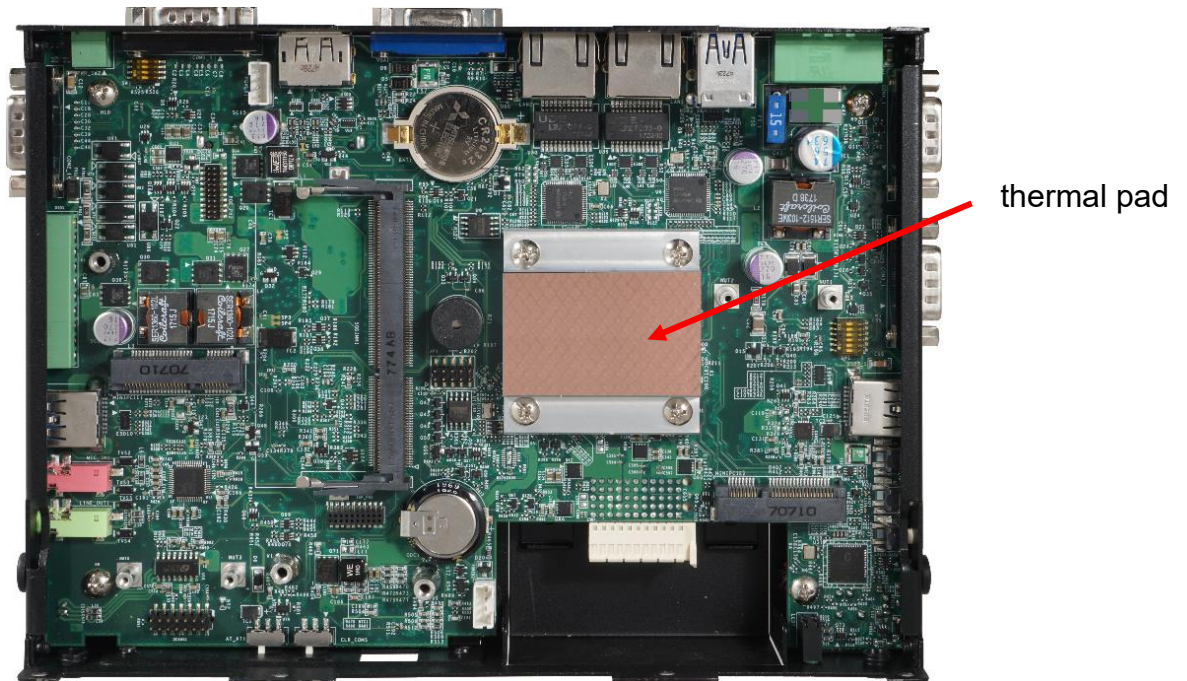

CAUTION

**Before assembling the system's chassis cover, please make sure the protective film on the Thermal Pad has been removed!**



## 3.6 Installing Top Cover

1. Put on the cover.



2. Fasten the 8 screws to fix the cover.

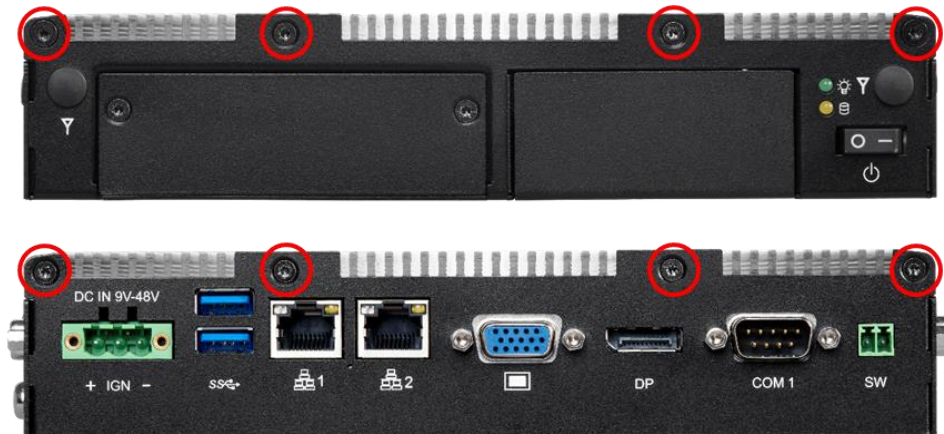

## 3.7 Installing SATA Hard Drive

1. Loosen 2 screws on front panel to remove cover plate.

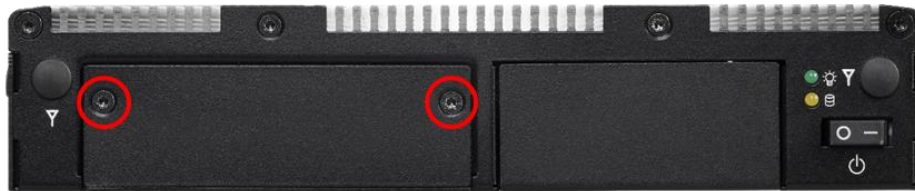

2. Turn over the unit to have the bottom side face up and loosen 1 screw.



3. Pull out the HDD bracket.

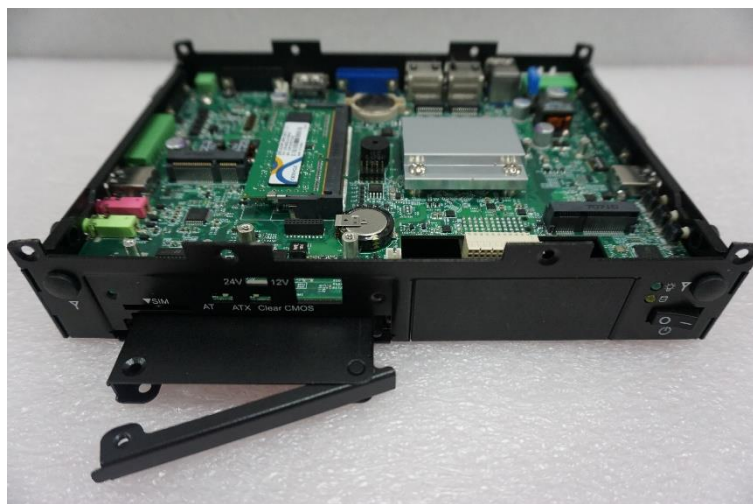

4. Make the bottom side of the HDD face up, place the HDD bracket on it. Ensure the direction of bracket is correct and use 4 provided screws to assemble HDD and HDD bracket together.

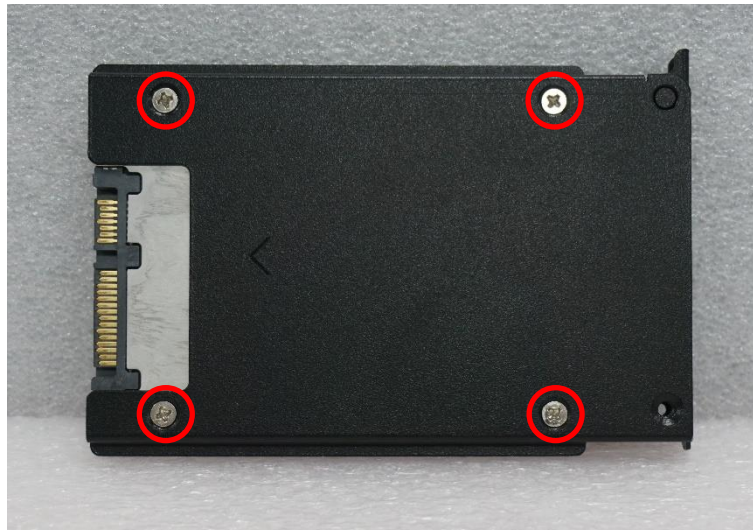

5. Align the HDD bracket with the entrance of HDD bay. And insert the HDD bracket until the connector of HDD contact the SATA connector firmly.



## 3.8 Installing SIM Card

1. Loosen 2 screws on front panel to remove cover plate.



2. SIM card slot is at the front panel of the system.



3. Insert the SIM card.



### 3.9 Disassemble the CO Display Module

The complete shipping product is the CO display module already installed on the P1100. This chapter will introduce how to disassemble CO display module and P1100.

1. Remove the 6 screws on the display module.

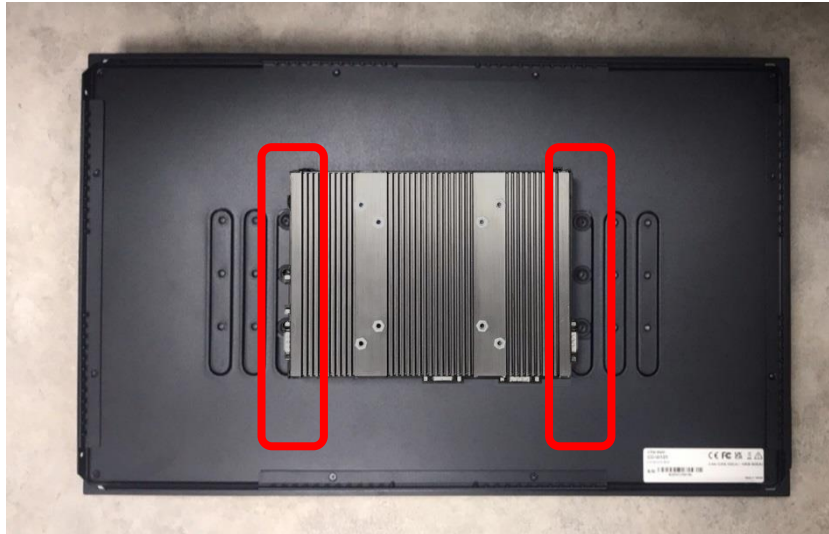

2. Disconnect the modules.

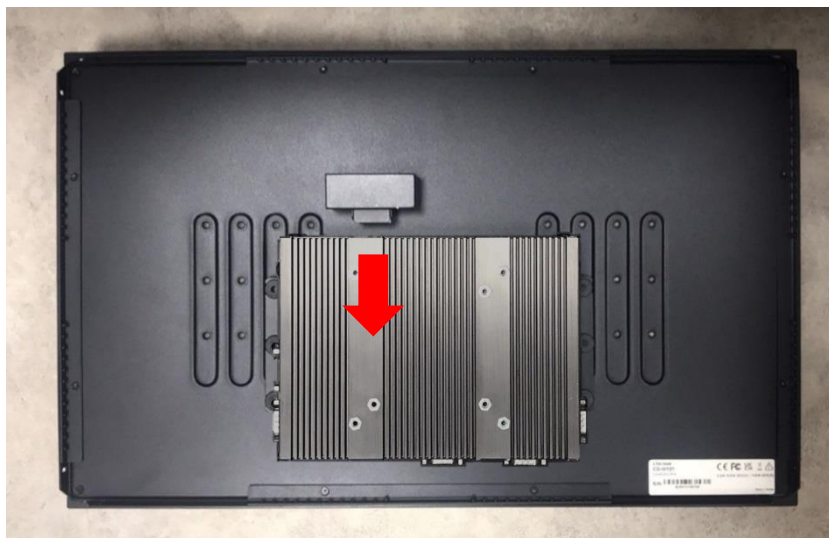

### 3.10 Installing Standard Mount

The CO-100 series currently features two types of Mounting Bracket designs. For example, the Mounting Bracket designs of CO-W121C and CO-119C as illustrated below.



CO-W121C



CO-119C

CO-119C is essentially identical to CO-W121C in terms of installation, with the only difference being the design of the Mounting Bracket. The following steps will demonstrate the installation using CO-W121C as an example.

Before doing the following steps, please make sure the screw positions are fastened at the default positions as indicated in the following picture. The default positions are the correct positions for Standard Mount, so it does not need to change the screw positions additionally for Standard Mount.



1. Put the CO-100/P1101 module onto the rack's back side.



There are two methods for fastening the CO-100/P1101 module onto the cabinet to complete the flat mount. One is to fix the CO-100/P1101 module from the front side of the cabinet, which is illustrated in chapter 3.10.1. The other one is to fix the CO-100/P1101 module from the rear side of the cabinet, which is illustrated in chapter 3.10.2.

### 3.10.1 Fixing from front side

1. Fasten the screws from the cabinet's front side. Please prepare 12 pcs of M4 screws for fixing the module through the **circle holes** (with screw thread).

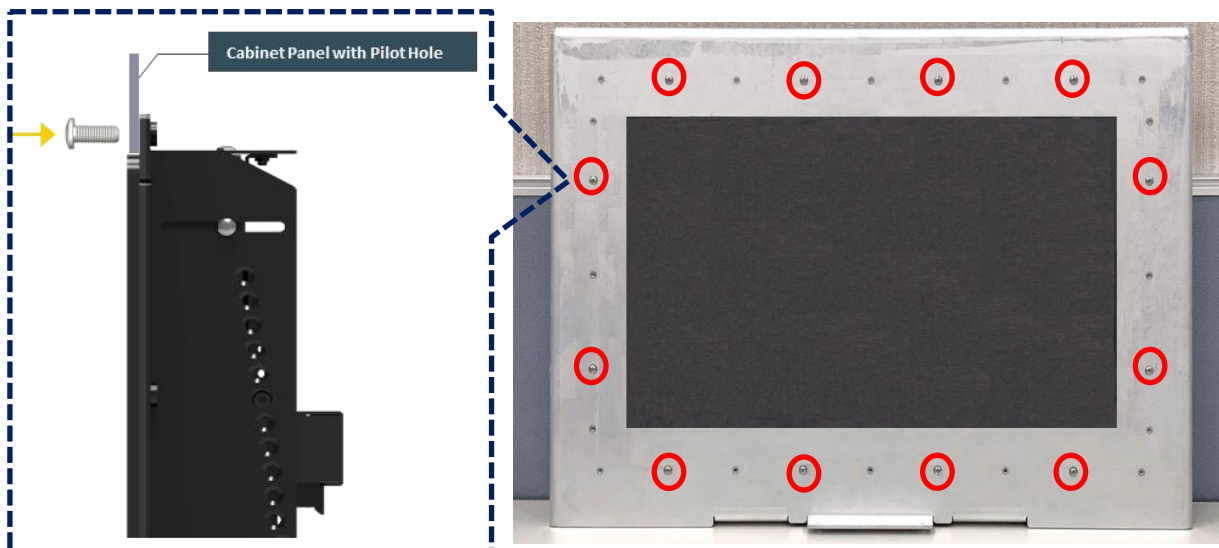

### 3.10.2 Fixing from rear side

1. If the cabinet panel is with stud bolts as the following figure, user can prepare 16 pcs of nuts for fixing the module through the **oblong holes** (oblong hole size: 9mmx4mm, without screw thread).

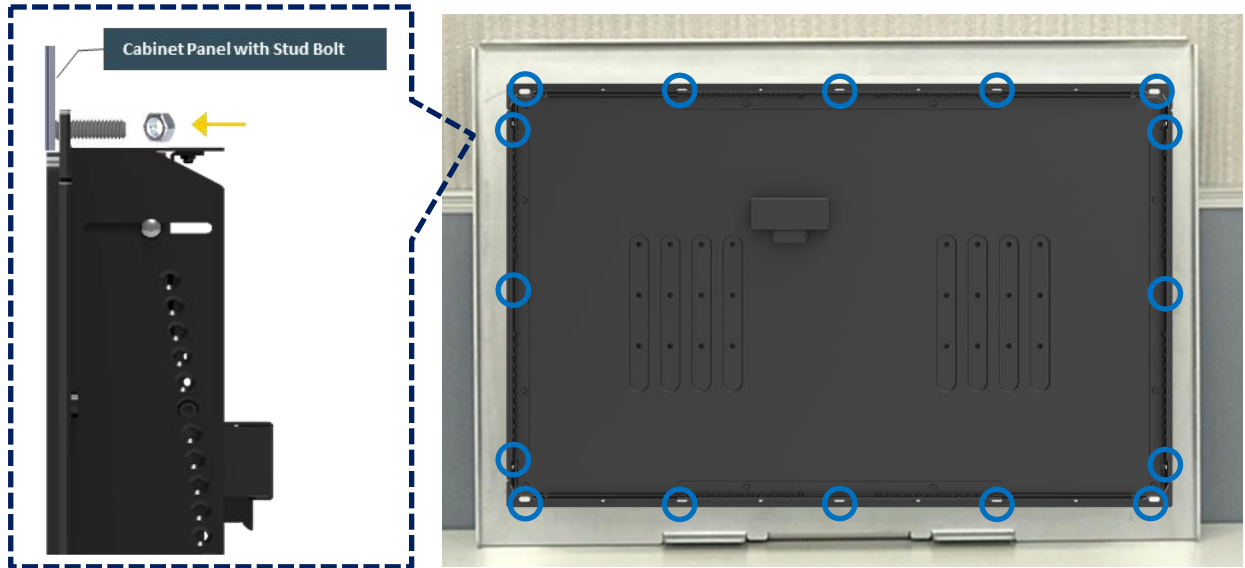

If the cabinet panel is with bosses as the following figures, user can prepare 16 pcs of M4 screws for fixing the module through the **oblong holes** (oblong hole size: 9mmx 4mm, without screw thread).

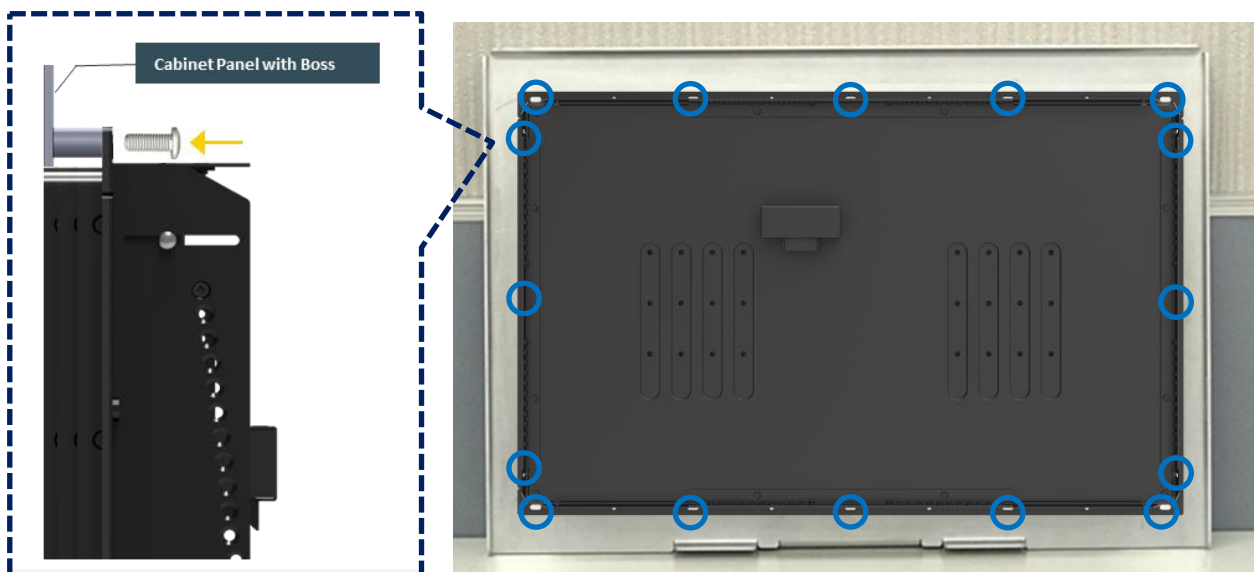



### 3.11 Flat Mount

The CO-100 series currently features two types of Mounting Bracket designs. For example, the Mounting Bracket designs of CO-W121C and CO-119C as illustrated below.



CO-W121C



CO-119C

CO-119C is essentially identical to CO-W121C in terms of installation, with the only difference being the design of the Mounting Bracket. The following steps will demonstrate the installation using CO-W121C as an example.

1. Locate the left and right-side mounting brackets.

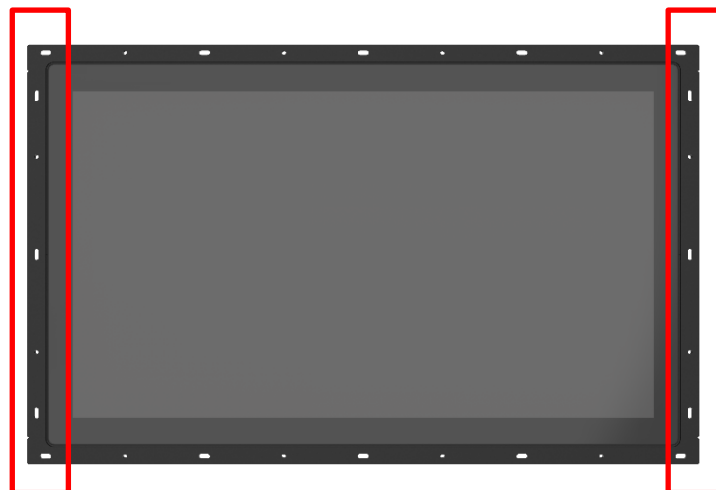

2. Remove the two screws on the left and right-side mounting brackets.



3. Loosen the three screws on the left and right-side mounting brackets.



4. Measure the rack thickness. The thickness is measured 3mm in this example.

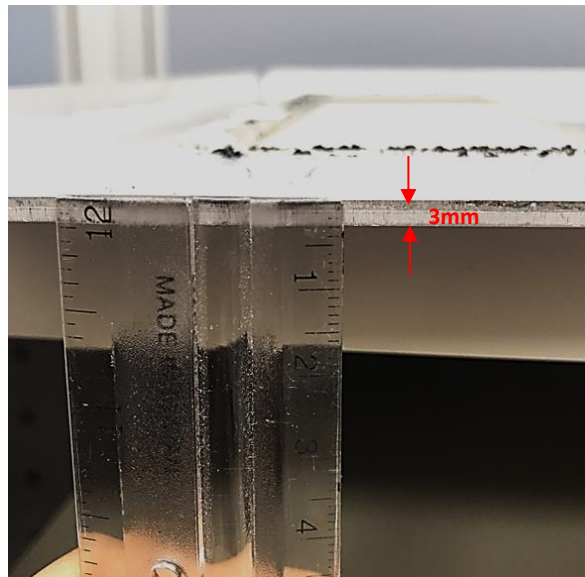

5. According to the thickness = 3mm for the example, push down the left and right-side mounting brackets to the place at screw hole = 3mm.



6. Fasten the two screws on the left and right-side mounting brackets.



7. Fasten the three screws on the left and right-side mounting brackets.



8. Locate the top and bottom-side mounting brackets.

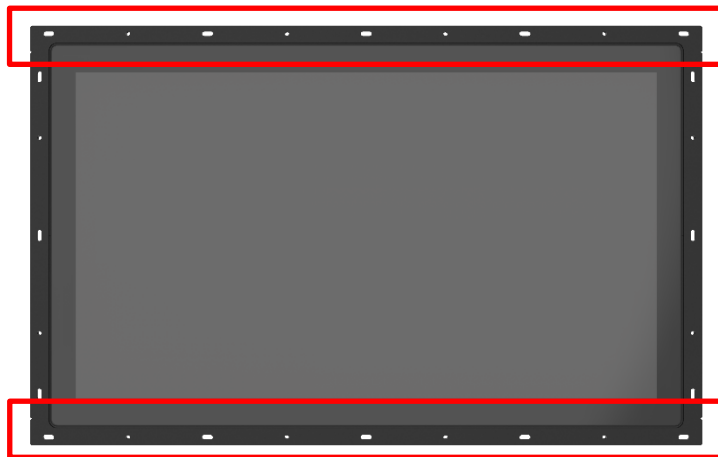

9. Remove the two screws on the top and bottom-side mounting brackets.

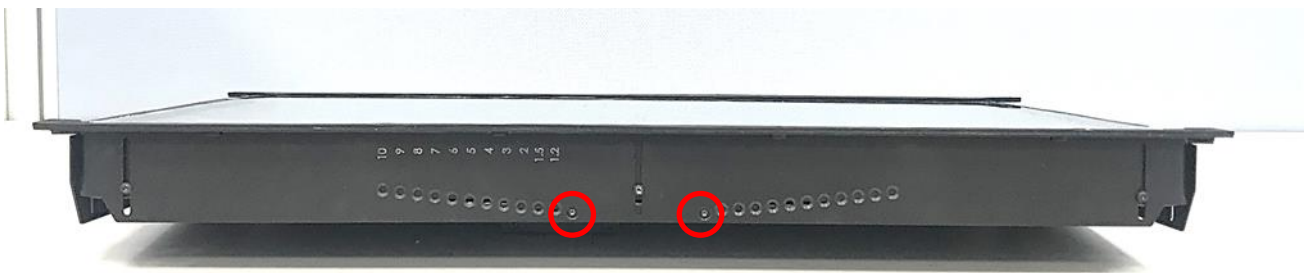

10. Loosen the three screws on the top and bottom-side mounting brackets.



11. According to the thickness = 3mm for the example, push down the top and bottom-side mounting brackets to the place at screw hole = 3mm.

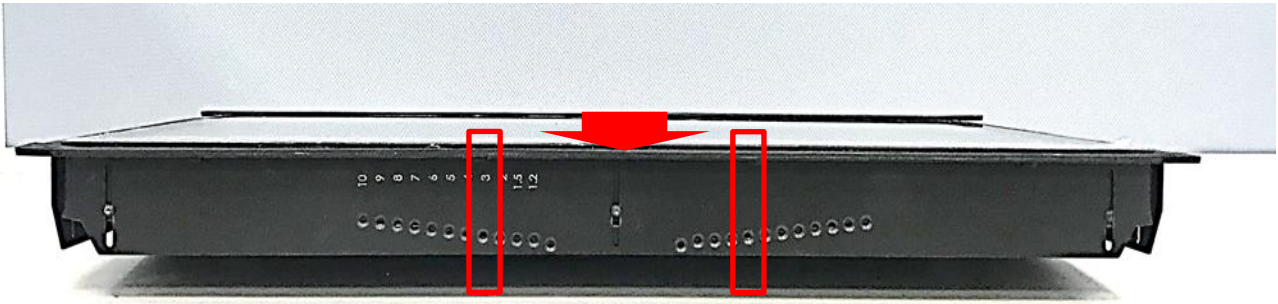

12. Fasten the two screws on the top and bottom-side mounting brackets.



13. Fasten the three screws on the top and bottom-side mounting brackets.



14. Put the CO-100/P1101 module onto the rack back side.



There are two methods for fastening the CO-100/P1101 module onto the cabinet to complete the flat mount. One is to fix the CO-100/P1101 module from the front side of the cabinet, which is illustrated in chapter 3.11.1. The other one is to fix the CO-100/P1101 module from the rear side of the cabinet, which is illustrated in chapter 3.11.2.

### 3.11.1 Fixing from front side

15. Fasten the screws from the cabinet's front side. Please prepare 12 pcs of M4 screws for fixing the module through the **circle holes** (with screw thread).

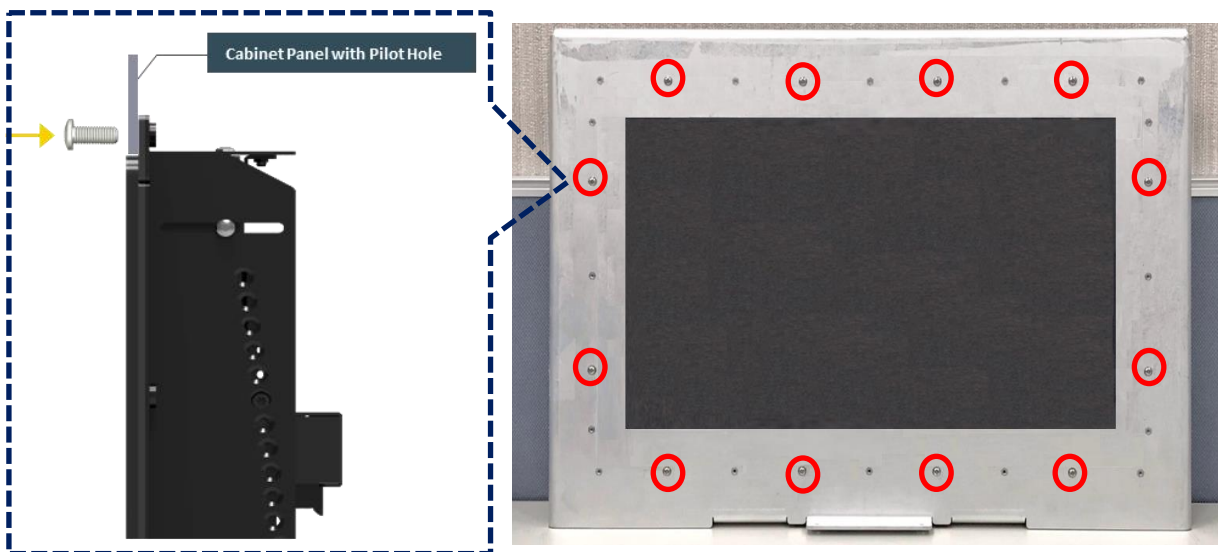

### 3.11.2 Fixing from rear side

15. If the cabinet panel is with stud bolts as the following figure, user can prepare 16 pcs of nuts for fixing the module through the **oblong holes** (oblong hole size: 9mmx4mm, without screw thread).

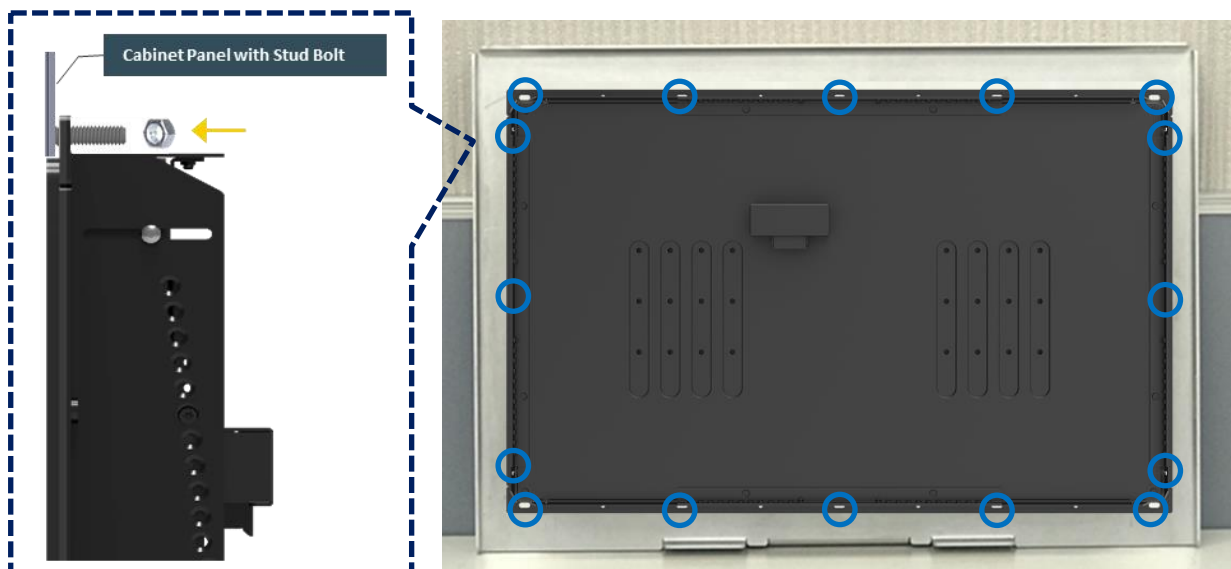

If the cabinet panel is with bosses as the following figures, user can prepare 16 pcs of M4 screws for fixing the module through the **oblong holes** (oblong hole size: 9mmx 4mm, without screw thread).

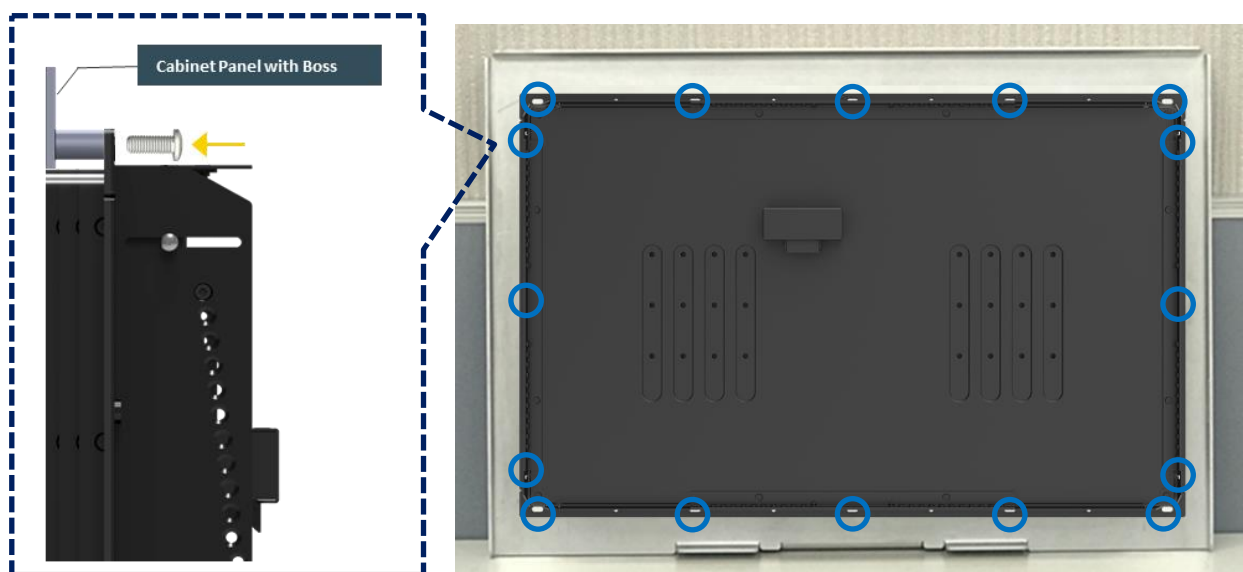

### 3.12 Disassemble the mounting brackets

The CO-100 series currently features two types of Mounting Bracket designs. For example, the Mounting Bracket designs of CO-W121C and CO-119C as illustrated below.



CO-W121C



CO-119C

CO-119C is essentially identical to CO-W121C in terms of installation, with the only difference being the design of the Mounting Bracket. The following steps will demonstrate the installation using CO-W121C as an example.

Before the installation of VESA mount and rack mount, user need to disassemble the mounting brackets on the CO display module first.

1. Remove the 8 screws.

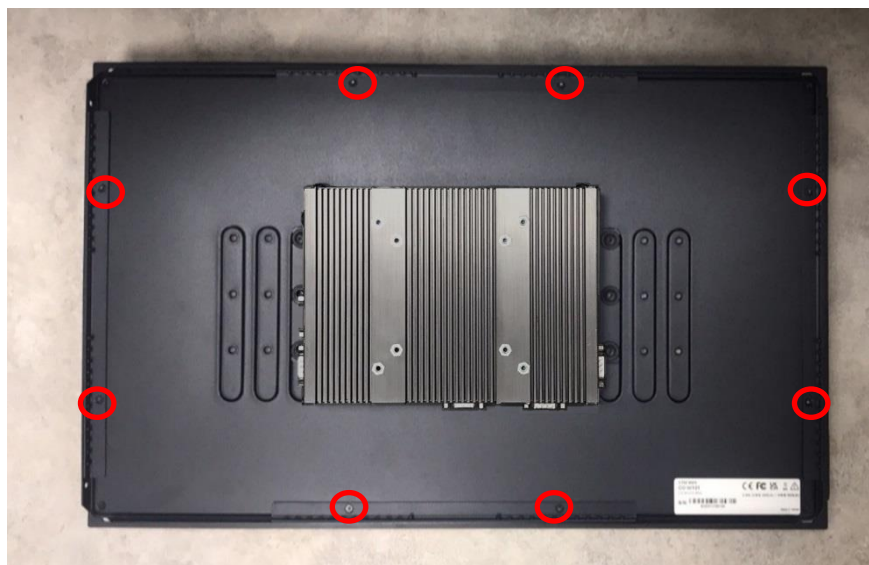



2. Remove the 3 screws on the left and right side of mounting brackets.





3. Remove the 3 screws on the top and bottom side of mounting brackets.



4. Remove the four mounting brackets.





# **Chapter 4**

## **BIOS Setup**

## 4.1 BIOS Introduction

The BIOS (Basic Input/ Output System) is a program located on a Flash Memory on the motherboard. When you start the computer, the BIOS program will gain control. The BIOS first operates an auto-diagnostic test called POST (power on self-test) for all the necessary hardware, it detects the entire hardware device and configures the parameters of the hardware synchronization.

### BIOS Setup

Power on the computer and by pressing <Del> immediately allows you to enter Setup. If the message disappears before your respond and you still wish to enter Setup, restart the system to try again by turning it OFF then ON or pressing <Ctrl>, <Alt> and <Delete> keys.

Control Keys	
<←> <→>	Move to select screen
<↑> <↓>	Move to select item
<Esc>	Quit the BIOS Setup
<Enter>	Select item
<Page Up/+>	Increases the numeric value or makes changes
<Page Down/->	Decreases the numeric value or makes changes
<Tab>	Select setup fields
<F1>	General help
<F2>	Previous value
<F3>	Load Optimized defaults
<F10>	Save configuration and Exit

### Main Menu

The main menu lists the setup functions you can make changes to. You can use the arrow keys ( ↑↓ ) to select the item. The on-line description of the highlighted setup function is displayed at the bottom of the screen.

### Sub-Menu

If you find a right pointer symbol appears to the left of certain fields that means a sub-menu can be launched from this field. A sub-menu contains additional options for a field parameter. You can use arrow keys ( ↑↓ ) to highlight the field and press <Enter> to call up the sub-menu. Then you can use the control keys to enter values and move from field to field within a sub-menu. If you want to return to the main menu, just press the <Esc >.

## 4.2 Main Setup

Press <Del> to enter BIOS CMOS Setup Utility, the Main Menu (as shown below) will appear on the screen. Use arrow keys to move among the items and press <Enter> to accept or enter a sub-menu.

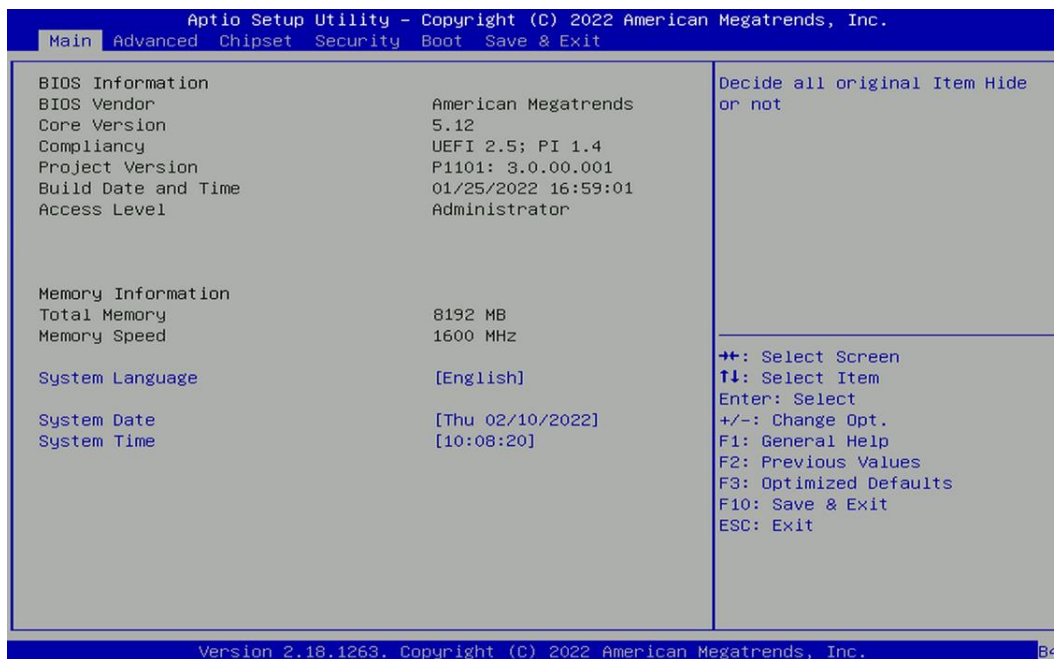

### 4.2.1 System Date

Set the date. Please use <Tab> to switch between date elements.

### 4.2.2 System Time

Set the time. Please use <Tab> to switch between time elements.

## 4.3 Advanced Setup

This section allows you to configure and improve your system and allows you to set up some system features according to your preference.

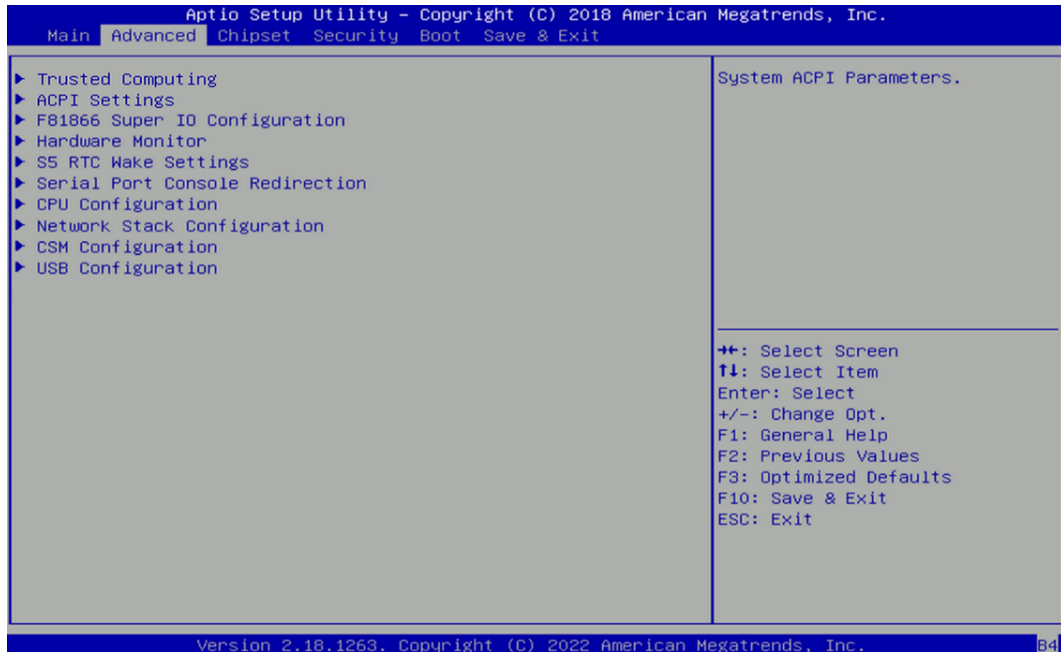

### 4.3.1 Trusted Computing Settings

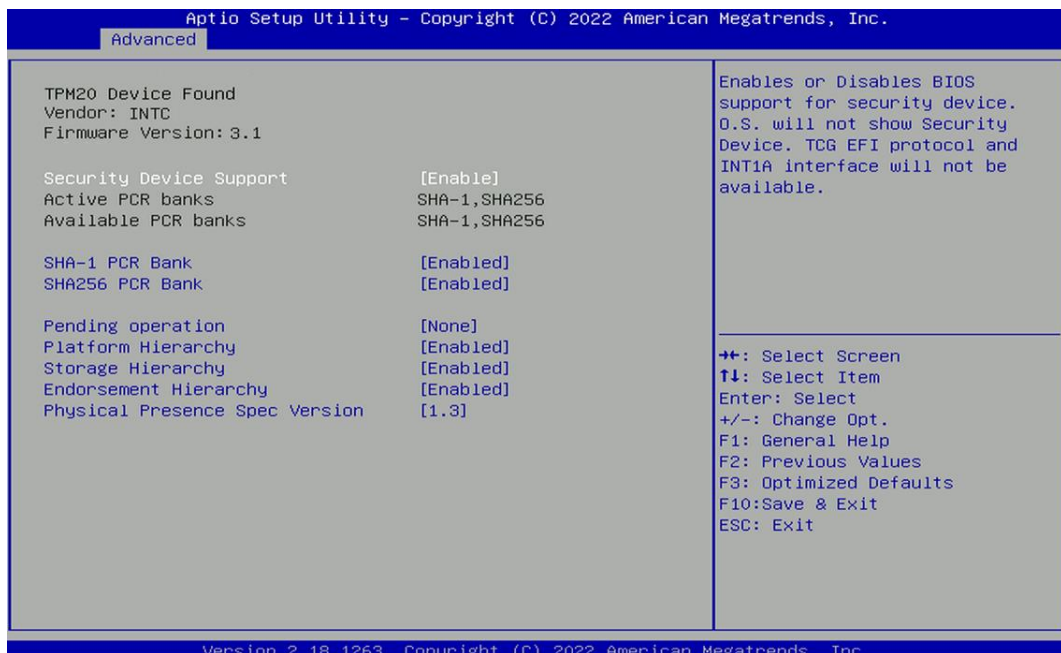

#### ■ Security Device Support [Enabled]

Enables or disables Security Device Support function.

#### ■ SHA-1 PCR Bank [Enabled]

Enables or disables SHA-1 PCR Bank function.

■ **SHA256 PCR Bank [Enabled]**

Enables or disables SHA256 PCR Bank function.

■ **Pending Operation [None]**

Allows you to select which mode Pending Operation will operate.

Configuration options: [None], [TPM Clear]

■ **Platform Hierarchy [Enabled]**

Enables or disables Platform Hierarchy function.

■ **Storage Hierarchy [Enabled]**

Enables or disables Storage Hierarchy function.

■ **Endorsement Hierarchy [Enabled]**

Enables or disables Endorsement Hierarchy function.

■ **Physical Presence Spec Version [1.3]**

Allows you to select which mode Physical Presence Spec Version will operate.

Configuration options: [1.2], [1.3]

### 4.3.2 ACPI Settings

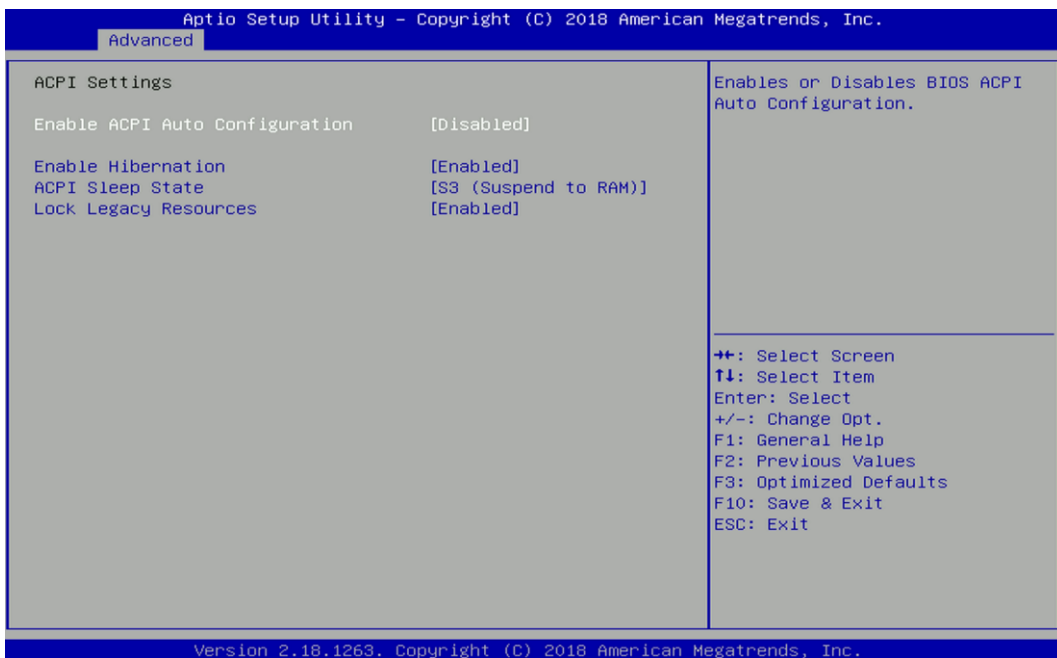

■ **Enable ACPI Auto Configuration [Disabled]**

Enables or disables BIOS Advanced Configuration Power Interface® (ACPI) auto configuration.

■ **Enable Hibernation [Enabled]**

Enables or disables system ability to hibernate state (OS/S4 state). This option may not be effective with some OS.

■ **ACPI Sleep State [S3 (Suspend to RAM)]**

Allows users to select the highest Advanced Configuration Power Interface® (ACPI) sleep state that system will enter when suspend button is pressed.

[Suspend Disabled]: Disables entering suspend state.

[S3 (suspend to RAM)]: Enables suspend to RAM state.

### ■ Lock Legacy Resources [Enabled]

Enables or disables Lock Legacy Resources.

### 4.3.3 F81866 Super IO Configuration

Set Parameters of Serial Ports. User can Enable/Disable the serial port and Select an optimal setting for the Super IO Device.

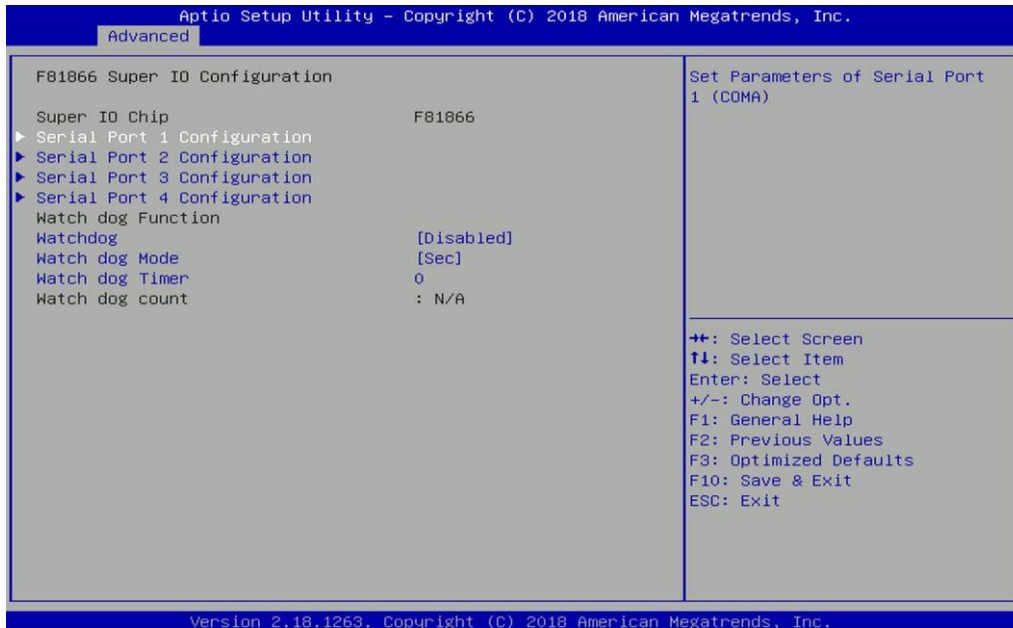

### ■ Serial Port 1~4 Configuration.

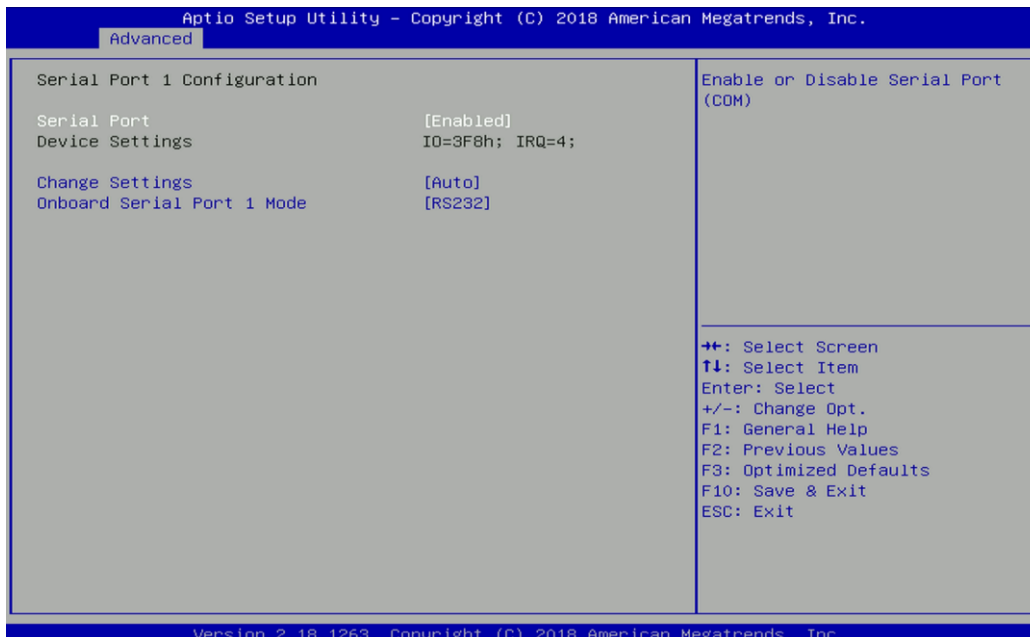

**Serial Port [Enabled]**

Enables or disables serial port.

**Change Settings [Auto]**

Allows you to change the IO Address & IRQ settings of the specified serial port.

**Onboard Serial Port 1~6 Mode [RS232]**

Allows you to select Serial Port Mode.

Configuration options: [RS232] [RS422/RS485 Full Duplex] [RS485 Half Duplex]

**Watch Dog [Disabled]**

Enables or disables watch dog function.

**Watch Dog Mode [Sec]**

Allows to set watchdog timer unit <Sec> or <Min>.

**Watch Dog Timer [0]**

Allows you to set watchdog timer's value in the range of 0 to 255.

### 4.3.4 Hardware Monitor

This screen displays the current status of all monitored hardware devices/components such as voltages, temperatures.

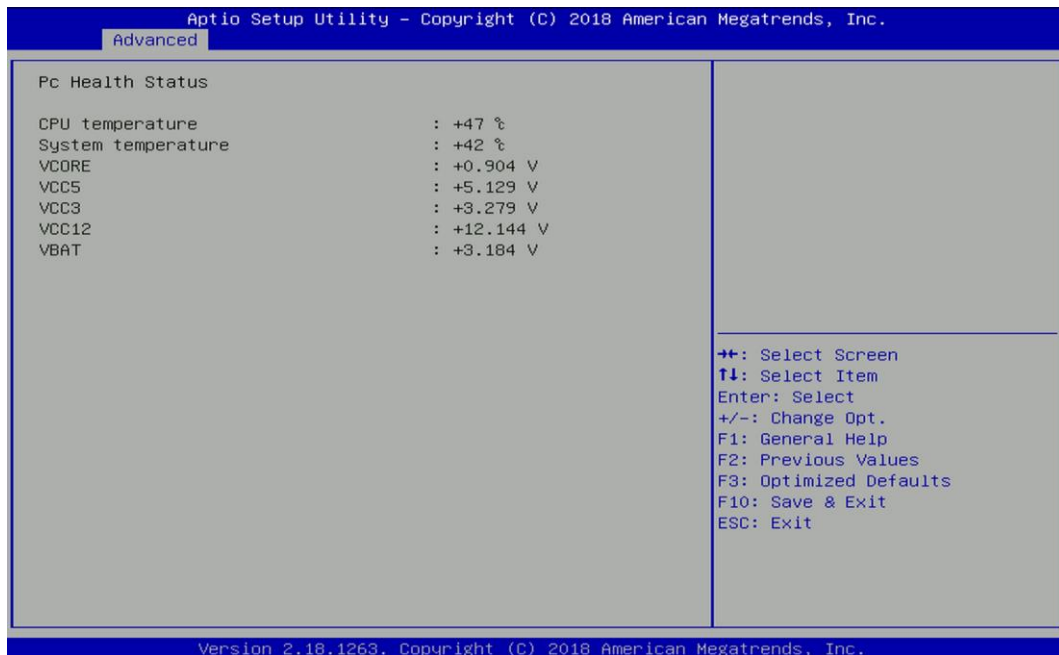



### 4.3.5 S5 RTC Wake Settings

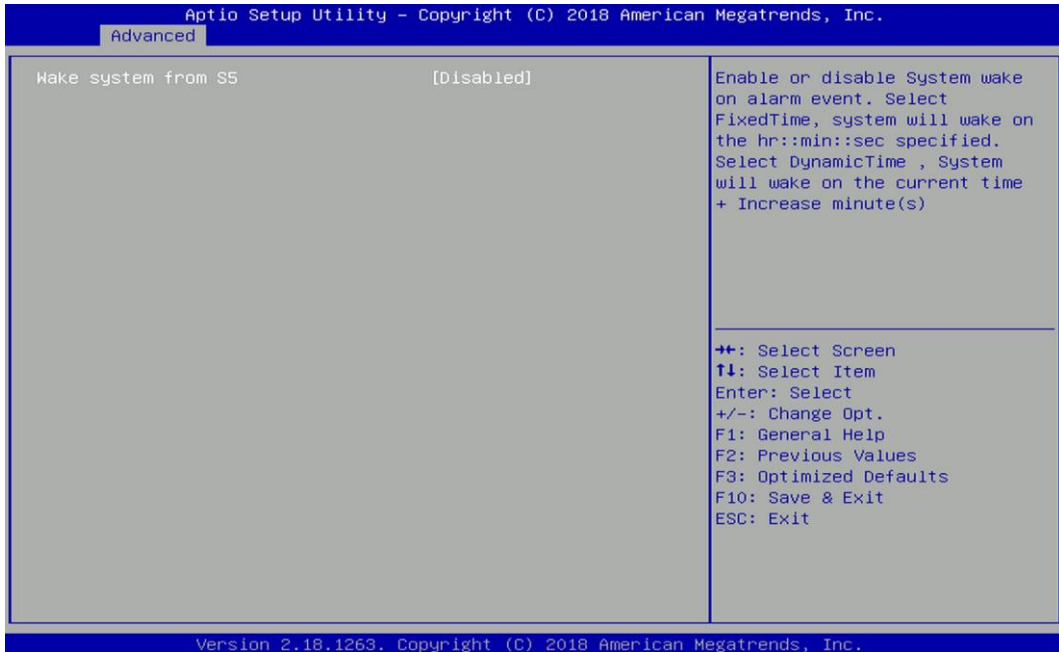

#### Wake system from S5 [Disabled]

Enables or disables wake system from S5 (soft-off state).

[Disabled]: Disables wake system from S5.

[Fixed Time]: Sets a fixed time (HH:MM:SS) to wake system from S5.

[Dynamic Time]: Sets an increase minute(s) from current time to wake system from S5.

### 4.3.6 Serial Port Console Redirection

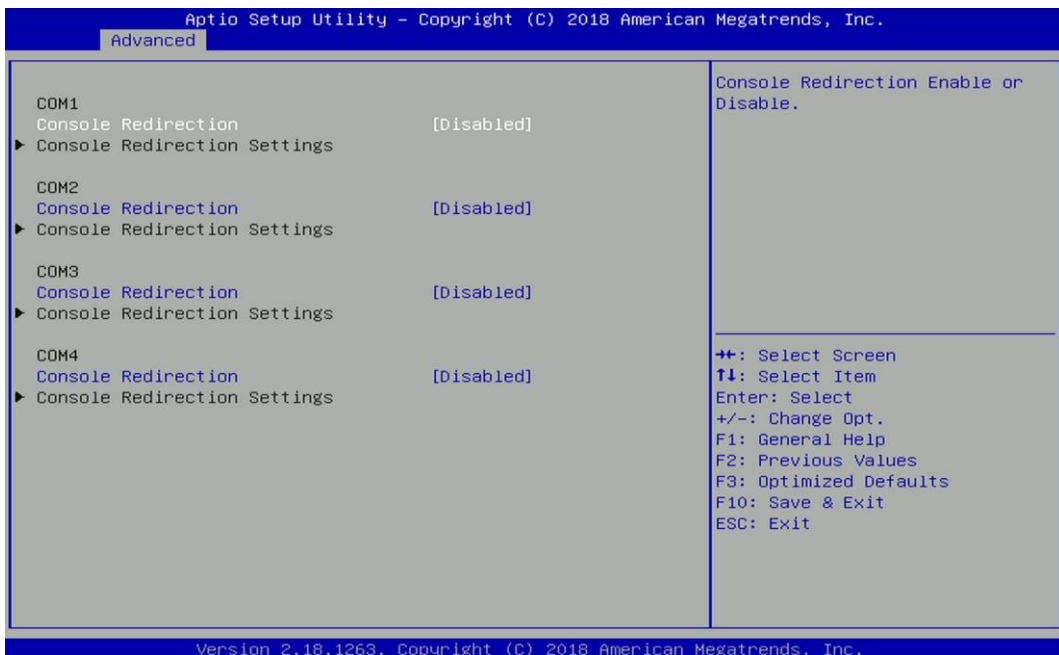

#### Console Redirection [Disabled]

Allow users to enable or disable COM1, COM2, COM3, COM4 console redirection function.

### 4.3.7 CPU Configuration

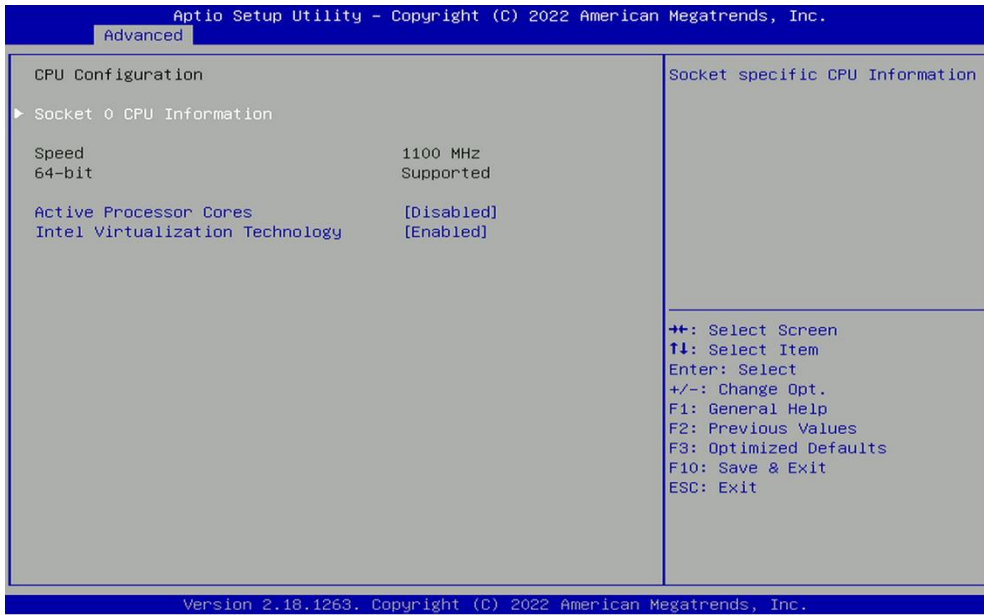

#### ■ Socket 0 CPU Information

This section provides information on your CPU, frequency, and cache memory.

#### ■ Active Processor Cores [Enabled]

Number of cores to enable in each processor package.

#### ■ Intel Virtualization Technology [Enabled]

Enables or disables Intel Virtualization Technology. Virtualization enhanced by Intel Virtualization Technology will allow a platform to run multiple operating systems and applications in independent partitions. With virtualization, one computer system can function as multiple virtual systems.

### 4.3.8 Network Stack Configuration

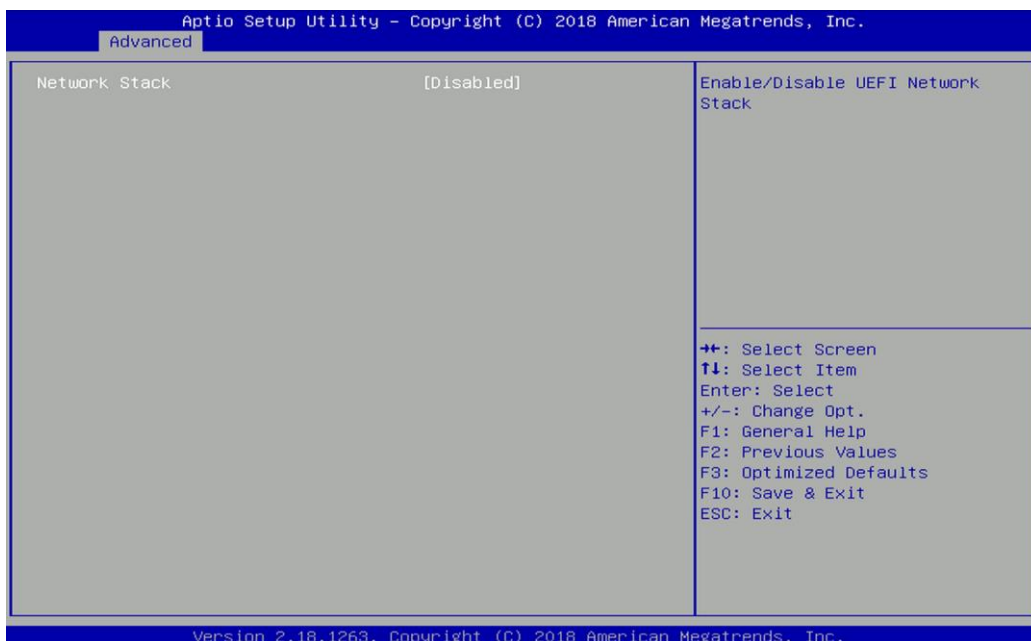

■ **Network Stack [Disabled]**

Enables or disables UEFI Network Stack.

**4.3.9 CSM Configuration**

This option controls legacy/UEFI ROMs priority.

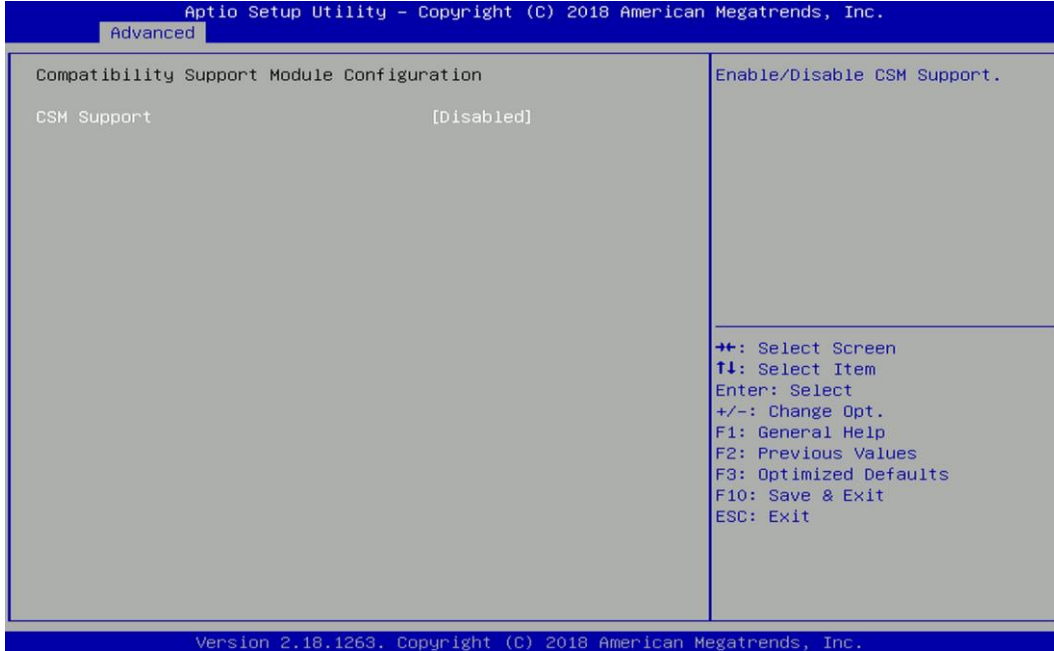

■ **CSM Support [Disabled]**

Enables or disables compatibility support module.

■ **Boot option filter [UEFI and Legacy]**

Allows you to select which type of operating system to boot.

[UEFI and Legacy]: Allows booting from operating systems that support legacy option ROM or UEFI option ROM.

[Legacy only]: Allows booting from operating systems that only support legacy option ROM.

[UEFI only]: Allows booting from operating systems that only support UEFI option ROM.

■ **Network PXE [Do not launch]**

Controls the execution of UEFI and Legacy PXE (Network Preboot eXecution Environment) option ROM.

[Do not launch]: Disables option ROM execution.

[UEFI]: Enables UEFI option ROM only.

[Legacy]: Enables legacy option ROM only.

■ **Storage [UEFI]**

Controls the execution of UEFI and Legacy Storage option ROM.

[Do not launch]: Disables option ROM execution.

[UEFI]: Enables UEFI option ROM only.

[Legacy]: Enables legacy option ROM only.

■ **Video [UEFI]**

Controls the execution of UEFI and Legacy Video option ROM.

[Do not launch]: Disables option ROM execution.

[UEFI]: Enables UEFI option ROM only.

[Legacy]: Enables legacy option ROM only.

#### ■ Other PCI devices [Do not launch]

Allows users to determine option ROM execution policy for device other than network, storage, or video.

### 4.3.10 USB Configuration

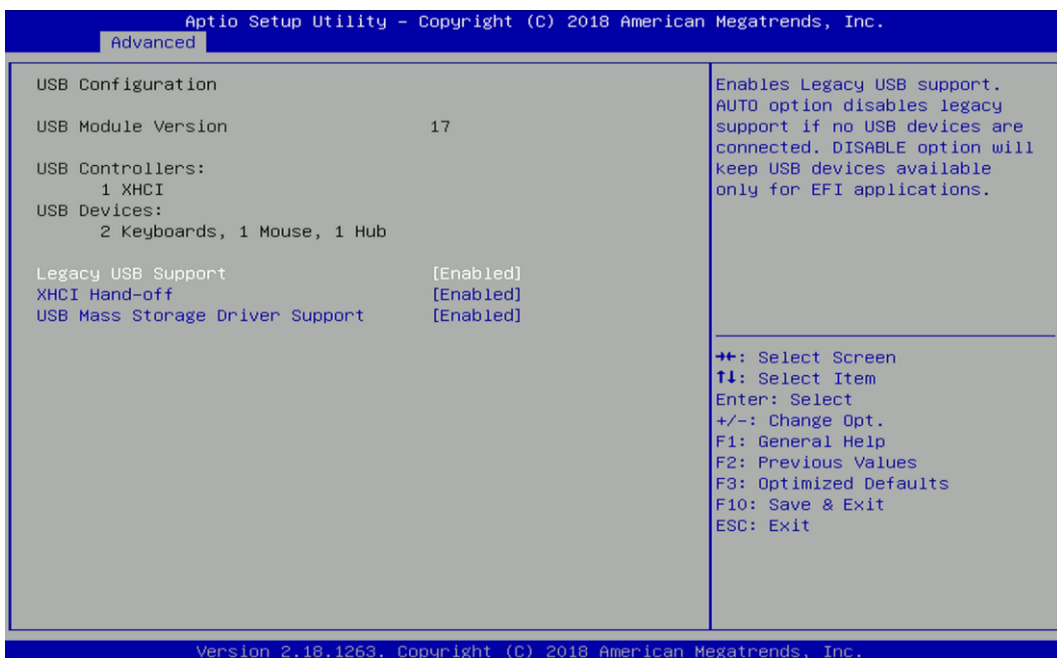

#### ■ Legacy USB Support [Enabled]

This item allows you to enable or disable legacy USB support. When set to [Auto], legacy USB support will be disabled automatically if no USB devices are connected.

#### ■ XHCI Hand-off [Enabled]

Enables or disables XHCI (USB3.0) hand-off function. Use this feature as a workaround for operating systems without XHCI hand-off support.

#### ■ USB Mass Storage Driver Support [Enabled]

Enables or disables USB mass storage driver support.

## 4.4 Chipset Setup

This section allows you to configure chipset related settings according to user's preference.

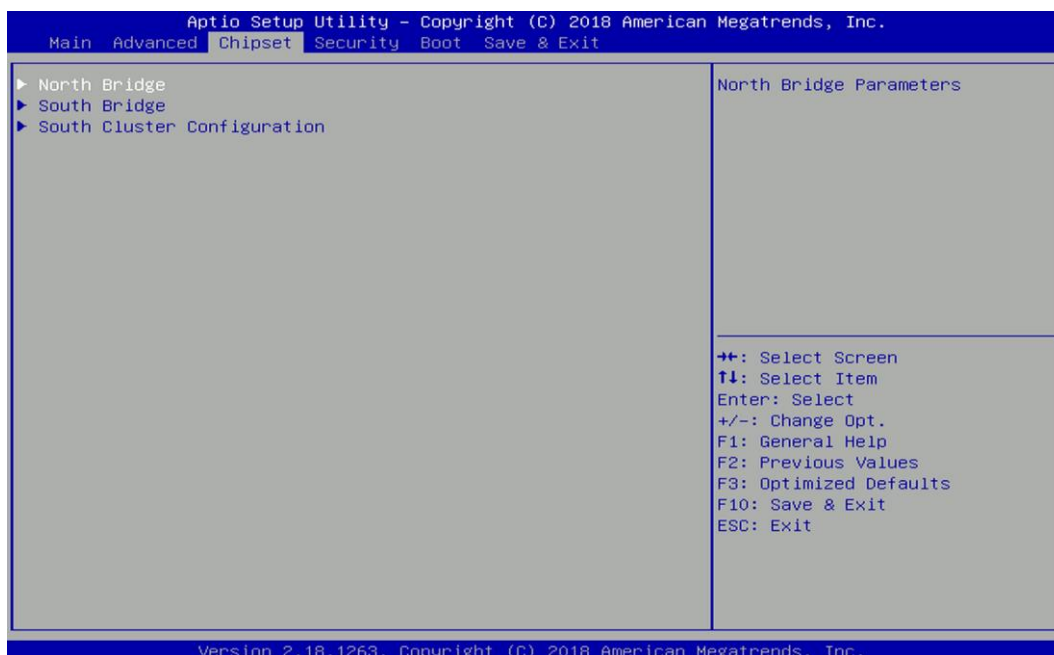

### 4.4.1 North Bridge

This section provides information on the installed memory size and memory/onboard graphics-related configuration options.

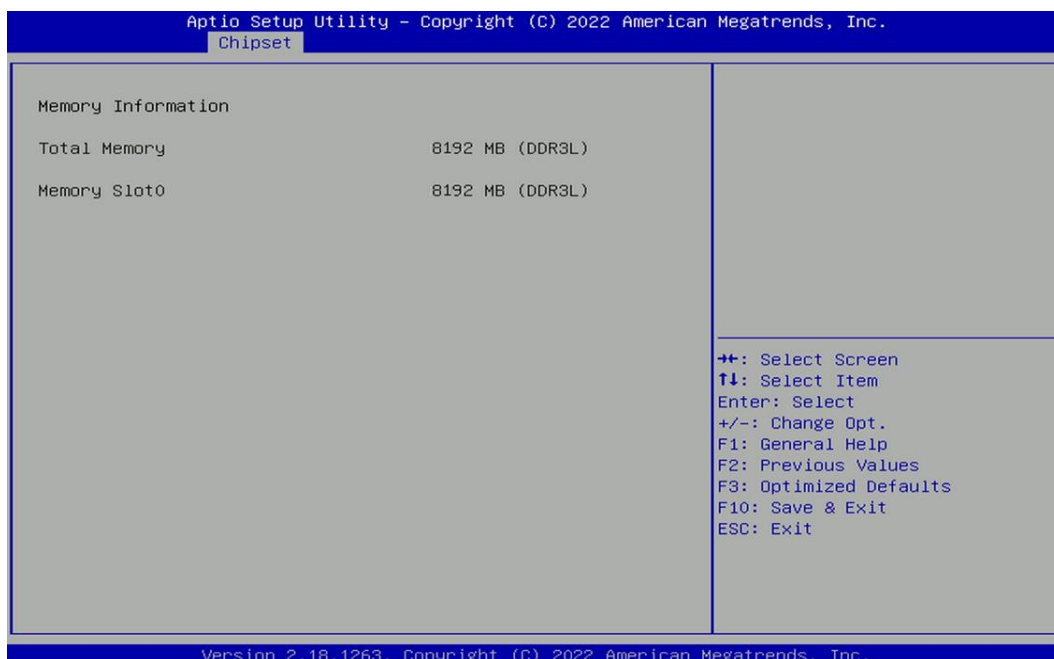

## 4.4.2 South Bridge

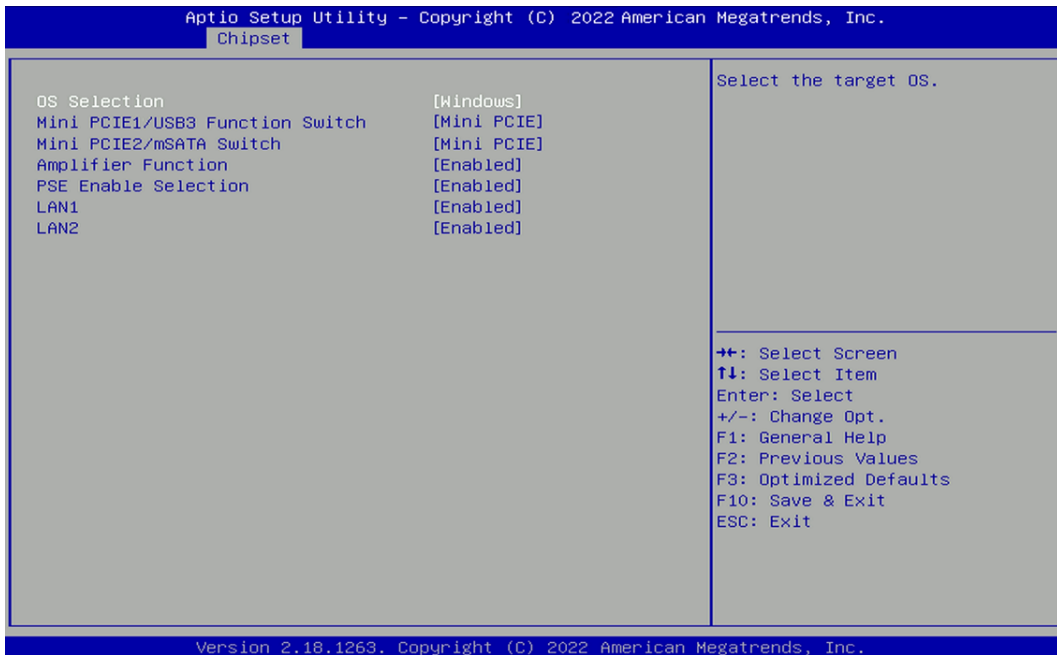

### ■ OS Selection [Windows]

Allows you to configure Operating System version to install.

Configuration options: [Windows] [Intel Linux]

### ■ Mini PCIE1/USB3 Switch [Mini PCIE]

Allows you to change **Mini PCIE1** as [Mini PCIE] or [USB3].

### ■ Mini PCIE2/mSATA Switch [Mini PCIE]

Allows you to change **Mini PCIE2** as [Mini PCIE] or [mSATA].

### ■ Amplifier Function [Enabled]

Enables or disables Amplifier Function.

### ■ PSE Enable Selection [Enabled]

Enables or disables PSE (Power Sourcing Equipment).

### ■ LAN1 [Enabled]

Enables or disables LAN1 Controller.

### ■ LAN2 [Enabled]

Enables or disables LAN2 Controller.

### 4.4.3 South Cluster Configuration

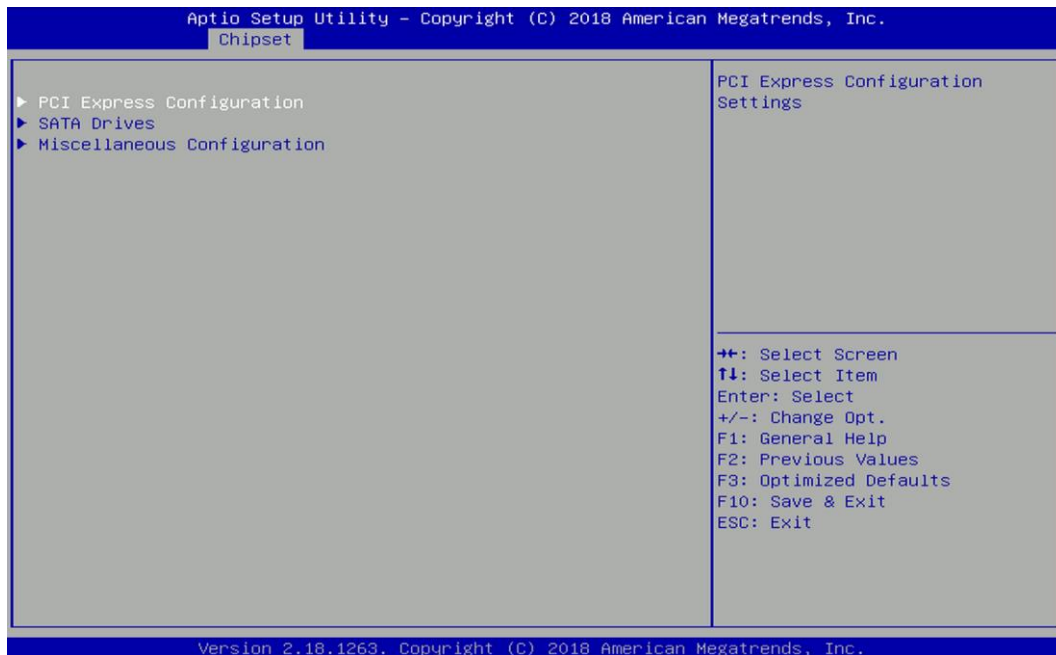

#### ■ PCI Express Configuration

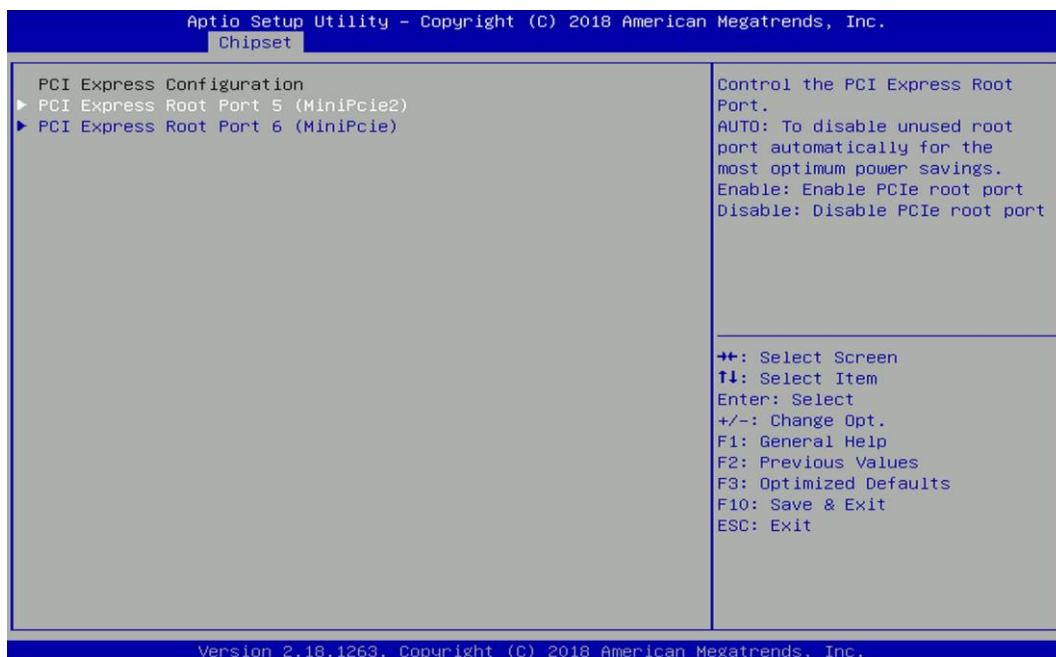

#### PCI Express Root Port 5 (MiniPcie2)

##### PCI Express Root Port 5 (MiniPcie2) [Enabled]

Enables or disables PCI Express Root Port.

##### PCIe Speed [Auto]

Allows you to select PCI Express port speed.

Configuration options: [Auto] [Gen1] [Gen2].

## PCI Express Root Port 6 (MiniPcie)

### PCI Express Root Port 6 (MiniPcie) [Enabled]

Enables or disables PCI Express Root Port.

### PCIe Speed [Auto]

Allows you to select PCI Express port speed.

Configuration options: [Auto] [Gen1] [Gen2].

## ■ SATA Devices

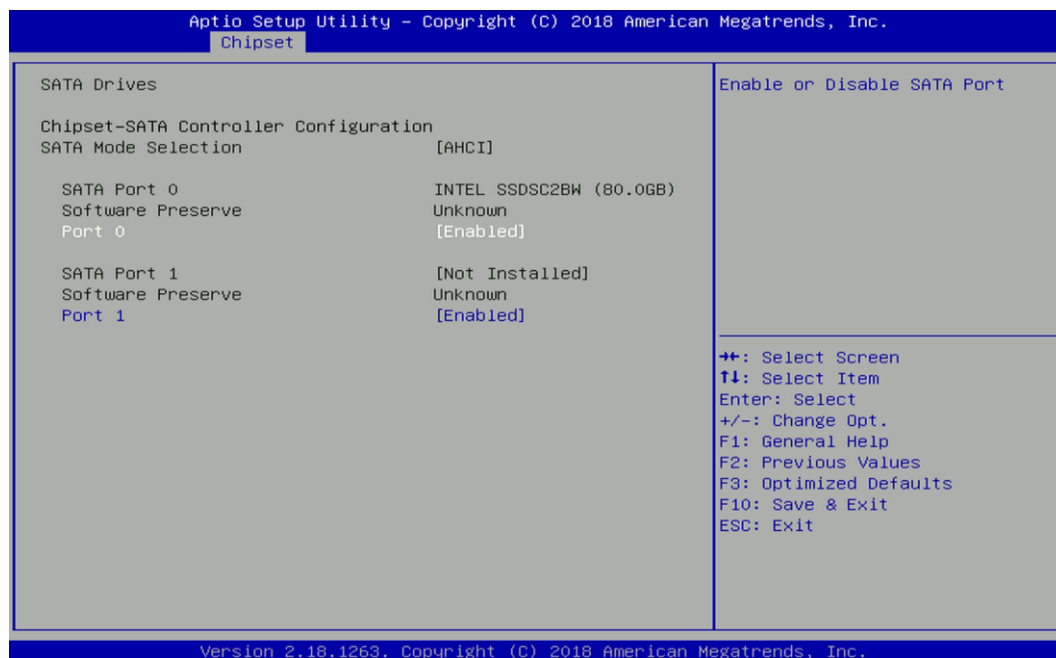

## SATA Port 0

### Port 0 [Enabled]

Enables or disables SATA Port 0 (SATA1).

## SATA Port 1

### Port 1 [Enabled]

Enables or disables SATA Port 1 (MINIPCI2).



## ■ Miscellaneous Configuration

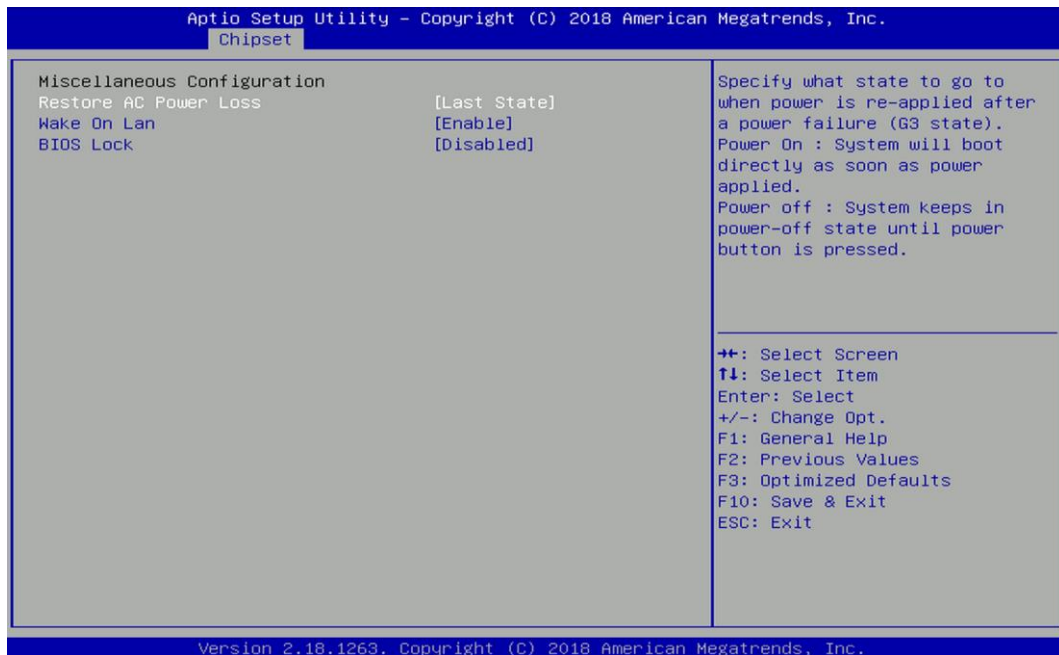

### Restore AC Power Loss [Last state]

Allows you to specify which power state system will enter when power is resumed after a power failure (G3 state).

[Always on]: Enters to power on state.

[Always off]: Enters to power off state.

[Last state]: Enters to the last power state before a power failure.

### Wake On Lan [Enabled]

Enables or disables Wake On LAN (WOL) function.

### BIOS Lock [Disabled]

Enables or disables BIOS the SC BIOS Lock enable feature. It is required to be enabled to ensure SMM protection of flash.

## 4.5 Security Setup

This section allows users to configure BIOS security settings.

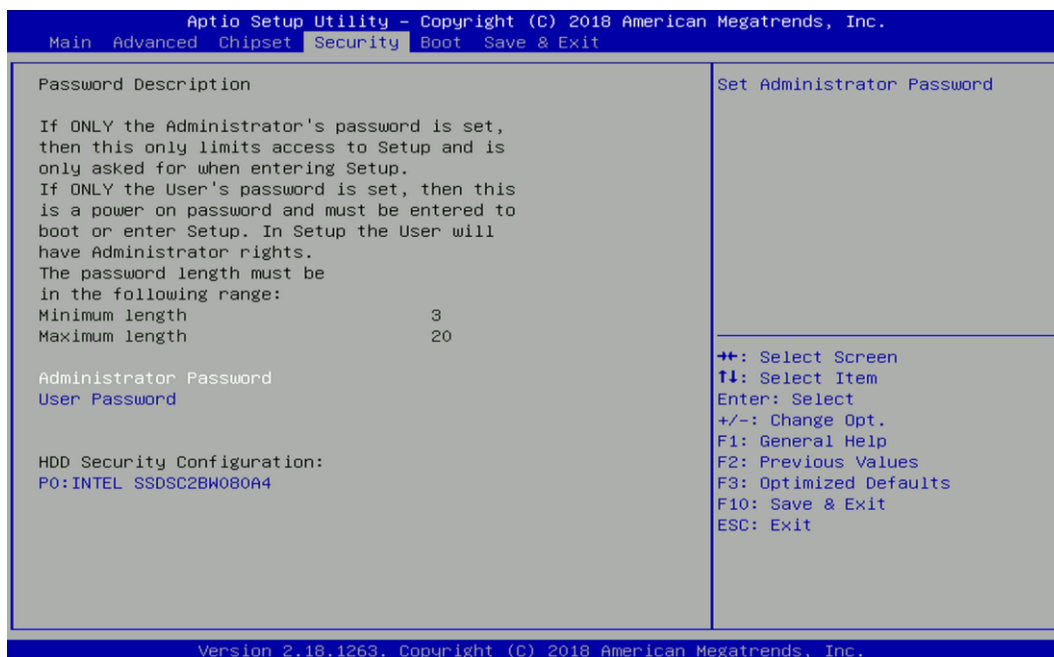

### 4.5.1 Administrator Password

Administrator Password controls access to the BIOS Setup utility.

### 4.5.2 User Password

User Password controls access to the system at boot and to the BIOS Setup utility.

## 4.6 Boot Setup

This section allows you to configure Boot settings.

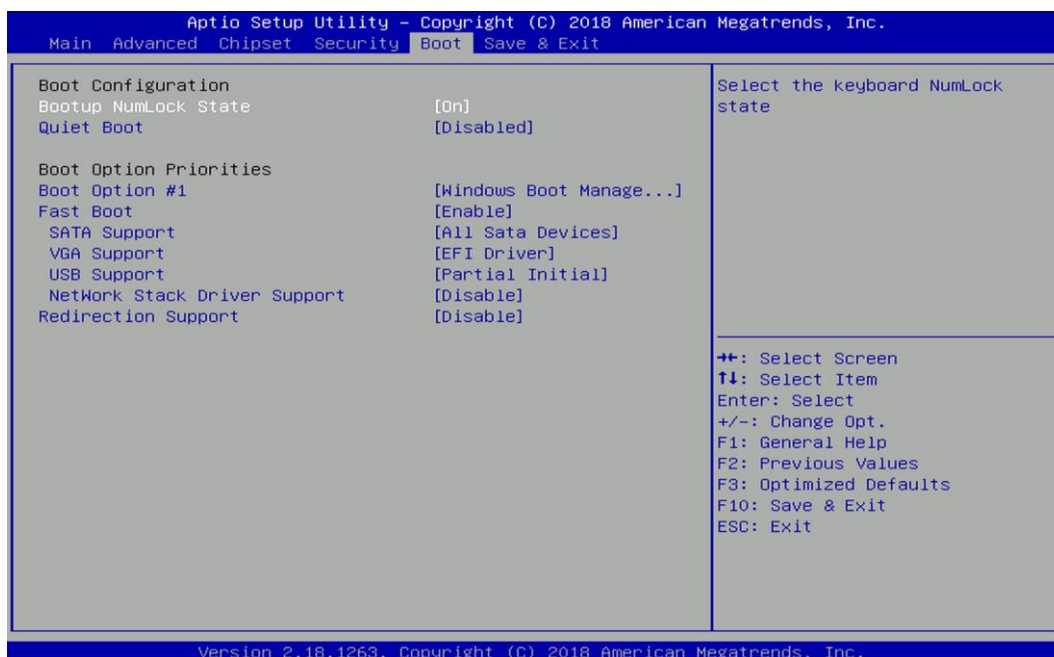

### ■ Bootup NumLock State

Allows you to set NumLock key to [On] or [Off] state when system boots up.

### ■ Quiet Boot

Allows you to enable or disable Quiet Boot function.

### ■ Fast Boot

Allows you to enable or disable Fast Boot function. If enabled, system boots with initialization of a minimal set of devices required to launch active boot option.

### ■ Hard Drive BBS Priority

Allows you to set the order of the legacy devices in this group.

## 4.7 Save & Exit



### ■ Save Changes and Reset

This item allows you to reset the system after saving changes.

### ■ Discard Changes and Reset

This item allows you to reset system setup without saving any changes.

### ■ Restore Defaults

This item allows you to restore/ load default values for all the setup options.

### ■ Save as User Defaults

This item allows you to save the changes done so far as user defaults.

### ■ Restore User Defaults

This item allows you to restore the user defaults to all the setup options.



# **Chapter 5**

## **Product Application**

## 5.1 Digital I/O (DIO) application

This section describes DIO application of the product. The content and application development are better understood and implemented by well experienced professionals or developers.

### 5.1.1 Digital I/O Programming Guide

#### 5.1.1.1 Pins for Digital I/O of Cincoze P1101 series product

Item	Standard
GPIO74 (Pin107)	DI
GPIO75 (Pin108)	
GPIO76 (Pin109)	
GPIO77 (Pin110)	
GPIO80 (Pin111)	DO
GPIO81 (Pin112)	
GPIO82 (Pin113)	
GPIO83 (Pin114)	

#### 5.1.1.2 Programming Guide

To program the Super I/O chip F81866A configuration registers, the following configuration procedures must be followed in sequence:

- (1) Enter the Extended Function Mode
- (2) Configure the configuration registers
- (3) Exit the Extended Function Mode

The configuration register is used to control the behavior of the corresponding devices. To configure the register, use the index port to select the index and then write data port to alter the parameters. The default index port and data port are 0x4E and 0x4F, respectively. **To enable configuration, the entry key 0x87 must be written to the index port. To disable configuration, write exit entry key 0xAA to the index port.** Following is an example to enable configuration and to disable configuration by using debug.

```
-o 4e 87
```

- o 4e 87 (enable configuration)
- o 4e aa (disable configuration)

### 5.1.1.3 Relative Registers

To program the F81866A configuration registers, see the following configuration procedures.

#### Logic Device Number Register (LDN) — Index 07h

Bit	Name	R/W	Reset	Default	Description
7-0	LDN	R/W	LRESET#	00h	00h: Select FDC device configuration registers. 03h: Select Parallel Port device configuration registers. 04h: Select Hardware Monitor device configuration registers. 05h: Select KBC device configuration registers. <b>06h: Select GPIO device configuration registers.</b> 07h: Select WDT device configuration registers. 0Ah: Select PME, ACPI and ERP device configuration registers. 10h: Select UART1 device configuration registers. 11h: Select UART2 device configuration registers. 12h: Select UART3 device configuration registers. 13h: Select UART4 device configuration registers. 14h: Select UART5 device configuration registers. 15h: Select UART6 device configuration registers. Otherwise: Reserved.

#### 7.7.11.1GPIO7 Output Enable Register — Index 80h

Bit	Name	R/W	Reset	Default	Description
7	GPIO77_OE	R/W	LRESET#	0	0: GPIO77 is in input mode. 1: GPIO77 is in output mode.
6	GPIO76_OE	R/W	LRESET#	0	0: GPIO76 is in input mode. 1: GPIO75 is in output mode.
5	GPIO75_OE	R/W	LRESET#	0	0: GPIO75 is in input mode. 1: GPIO75 is in output mode.
4	GPIO74_OE	R/W	LRESET#	0	0: GPIO74 is in input mode. 1: GPIO74 is in output mode.

#### 7.7.11.3GPIO7 Pin Status Register — Index 82h (This byte could be also read by base address + 3)

Bit	Name	R/W	Reset	Default	Description
7	GPIO77_IN	R	-	-	The pin status of GPIO77/STB#.
6	GPIO76_IN	R	-	-	The pin status of GPIO76/AFD#.
5	GPIO75_IN	R	-	-	The pin status of GPIO75/ERR#.
4	GPIO74_IN	R	-	-	The pin status of GPIO74/INIT#.

### 7.7.12.1 GPIO8 Output Enable Register — Index 88h

3	GPIO83_OE	R/W	LRESET#	1	0: GPIO83 is in input mode. 1: GPIO83 is in output mode.
2	GPIO82_OE	R/W	LRESET#	1	0: GPIO82 is in input mode. 1: GPIO82 is in output mode.
1	GPIO81_OE	R/W	LRESET#	1	0: GPIO81 is in input mode. 1: GPIO81 is in output mode.
0	GPIO80_OE	R/W	LRESET#	1	0: GPIO80 is in input mode. 1: GPIO80 is in output mode.

3	GPIO83_VAL	R/W	LRESET#	1	0: GPIO83 outputs 0 when in output mode. 1: GPIO83 outputs 1 when in output mode.
2	GPIO82_VAL	R/W	LRESET#	1	0: GPIO82 outputs 0 when in output mode. 1: GPIO82 outputs 1 when in output mode.
1	GPIO81_VAL	R/W	LRESET#	1	0: GPIO81 outputs 0 when in output mode. 1: GPIO81 outputs 1 when in output mode.
0	GPIO80_VAL	R/W	LRESET#	1	0: GPIO80 outputs 0 when in output mode. 1: GPIO80 outputs 1 when in output mode.

#### 5.1.1.4 Sample Code in C Language

##### 5.1.1.4.1 Control of GP74 to GP77 (DI1 ~ DI4)

```
#define AddrPort 0x4E
```

```
#define DataPort 0x4F
```

<Enter the Extended Function Mode>

```
WriteByte(AddrPort, 0x87)
```

```
WriteByte(AddrPort, 0x87) // Must write twice to enter Extended mode
```

<Select Logic Device>

```
WriteByte(AddrPort, 0x07)
```

```
WriteByte(dataPort, 0x06) // Select logic device 06h
```

<Input Mode Selection> // Set GP74 to GP77 input Mode

```
WriteByte(AddrPort, 0x80) // Select configuration register 80h
```

```
WriteByte(DataPort, 0x0X) // Set (bit 4~7) = 0 to select GP 74~77 as Input mode.
```

<Input Value>

```
WriteByte(AddrPort, 0x82) // Select configuration register 82h
```

```
ReadByte(DataPort, Value) // Read bit 4~7 (0xFF)= GP74 ~77 as High.
```



<Leave the Extended Function Mode>

```
WriteByte(AddrPort, 0xAA)
```

#### 5.1.1.4.2 Control of GP80 to GP83 (DO1 ~ DO4)

```
#define AddrPort 0x4E
```

```
#define DataPort 0x4F
```

<Enter the Extended Function Mode>

```
WriteByte(AddrPort, 0x87)
```

```
WriteByte(AddrPort, 0x87) // Must write twice to enter Extended mode
```

<Select Logic Device>

```
WriteByte(AddrPort, 0x07)
```

```
WriteByte(DataPort, 0x06) // Select logic device 06h
```

<Output Mode Selection> // Set GP80 to GP83 output Mode

```
WriteByte(AddrPort, 0x88) // Select configuration register 88h
```

```
WriteByte(DataPort, 0xFF) // Set (bit 0~3) = 1 to select GP 80 ~83 as Output mode.
```

<Output Value>

```
WriteByte(AddrPort, 0x89) // Select configuration register 89h
```

```
WriteByte(DataPort, Value) // Set bit 0~3=(0/1) to output GP 80~83 as Low or High
```

<Leave the Extended Function Mode>

```
WriteByte(AddrPort, 0xAA)
```

### 5.1.1.5 Change base address - DIO base address (Cincoze default 0xA00)

<Enter the Extended Function Mode>

```
WriteByte(AddrPort, 0x87)
```

```
WriteByte(AddrPort, 0x87) // Must write twice to enter Extended mode
```

<Select Logic Device>

```
WriteByte(AddrPort, 0x07)
```

```
WriteByte(dataPort, 0x06) // Select logic device 06h
```

```
WriteByte(AddrPort, 0x60) // Select configuration register 60h (High Byte address)
```

```
WriteByte(DataPort, (0x0A))
```

```
WriteByte(AddrPort, 0x61) // Select configuration register 61h (Low Byte address)
```

```
WriteByte(DataPort, (0x00))
```

<Leave the Extended Function Mode>

```
WriteByte(AddrPort, 0xAA)
```

**Note:** Cincoze DIO Port base address is 0x0A00h.

### 5.1.1.6 DATA Bit Table (DIO)

7	6	5	4	3	2	1	0	bit
0	0	0	1	-	-	-	-	value
1				X				/h

= DI1

7	6	5	4	3	2	1	0	bit
-	-	-	-	0	0	0	1	value
X				1				/h

= DO1

7	6	5	4	3	2	1	0	bit
0	0	1	0	-	-	-	-	value
2				X				/h

= DI2

7	6	5	4	3	2	1	0	bit
-	-	-	-	0	0	1	0	value
X				2				/h

= DO2

7	6	5	4	3	2	1	0	bit
0	1	0	0	-	-	-	-	value
4				X				/h

= DI3

7	6	5	4	3	2	1	0	bit
-	-	-	-	0	1	0	0	value
X				4				/h

= DO3

7	6	5	4	3	2	1	0	bit
1	0	0	0	-	-	-	-	value
8				X				/h

= DI4

7	6	5	4	3	2	1	0	bit
-	-	-	-	1	0	0	0	value
X				8				/h

= DO4

### 5.1.1.7 DIO I/O Port Address

DI4	DI3	DI2	DI1	DO4	DO3	DO2	DO1	Pin Definition
7	6	5	4	3	2	1	0	Data Bits
DI				DO				DIO
0xA03				0xA02				I/O Port address

## 5.2 Digital I/O (DIO) Hardware Specification

- XCOM+: Isolated power in V+
- XCOM-: Isolated power in V-
- Isolated power in DC voltage: 9~30V
- 4x Digital Input (Source Type)
- Input Signal Voltage Level
  - Signal Logic 0: XCOM+ = 9V,  $\text{Signal Low} - \underline{V-} < 1\text{V}$   
 $\text{XCOM+} > 9\text{V}, \quad \underline{V+} - \text{Signal Low} > 8\text{V}$
  - Signal Logic 1:  $> \underline{\text{XCOM+}} - \underline{3\text{V}}$
- Input Driving Sink Current:
  - Minimal: 1 mA
  - Normal: 5 mA
- 4x Digital Output (Open Drain)
  - DO Signal have to pull up resistor to XCOM+ for external device, the resistance will affect the pull up current
  - Signal High Level: Pull up resistor to XCOM+
  - Signal Low Level: = XCOM-
  - Sink Current: 1A (Max)



## 5.2.1 DIO Connector Definition

### DIO1: Digital Input / Output Connector

Connector Type: Terminal Block 1X10 10-pin, 3.5mm pitch

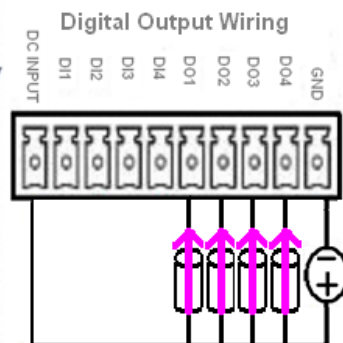
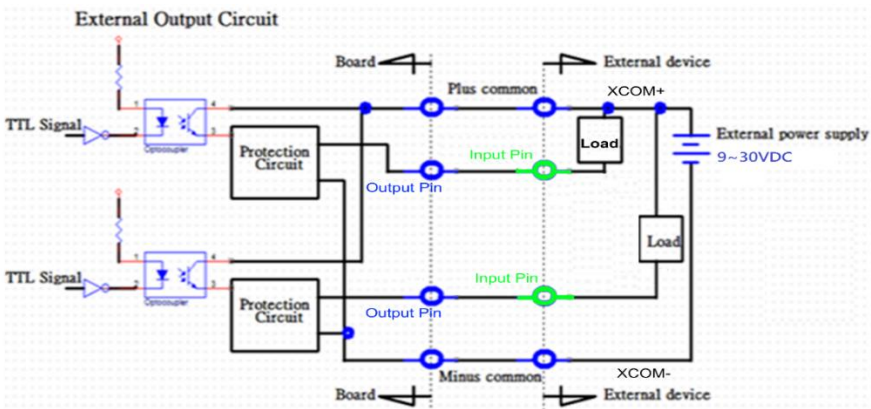
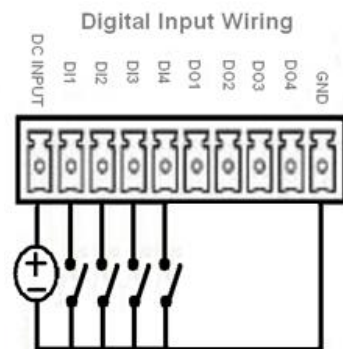
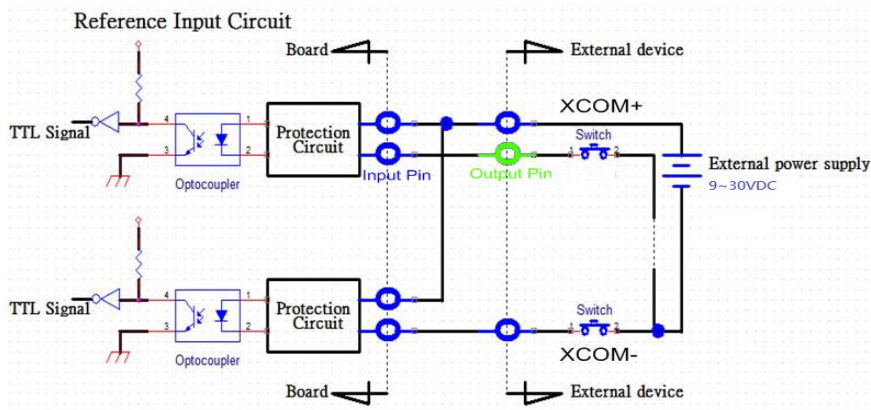
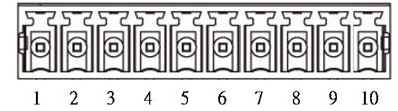
Pin	Definition	Pin	Definition
1	XCOM+ (DC INPUT)	6	DO1
2	DI1	7	DO2
3	DI2	8	DO3
4	DI3	9	DO4
5	DI4	10	XCOM- (GND)





# **Chapter 6**

## **Optional Modules and Accessories**

## 6.1 Location of the Connectors and Switches

Model No.	Description
CFM-IGN101	CFM Module with Power Ignition Sensing Control Function, 12V/24V Selectable
CFM-PoE02	CFM Module with PoE Control Function, Individual Port 25.5W

### SW2: IGN Function Switch

Set shutdown delay timer when ACC is turned off

Pin 1	Pin 2	Pin 3	Pin 4	Definition
OFF / ON	ON	ON	ON	0 second
	ON	ON	OFF	1 minute
	ON	OFF	ON	5 minutes
	ON	OFF	OFF	10 minutes
	OFF	ON	ON	30 minutes
	OFF	ON	OFF	1 hour
	OFF	OFF	ON	2 hours
	OFF	OFF	OFF	Reserved (0 second)

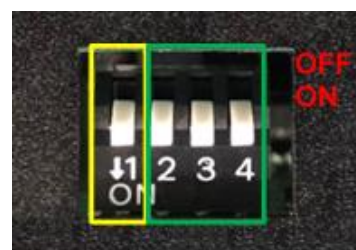

### 24V\_12V\_1: 12V / 24V Car Battery Switch

Pin	Definition
1-2	24V Car Battery Input
2-3	12V Car Battery Input

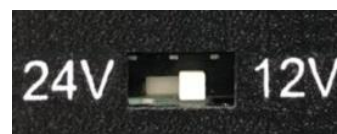

## 6.2 Installing CFM-IGN Module

1. Locate the IGN connector on system motherboard as indicated.

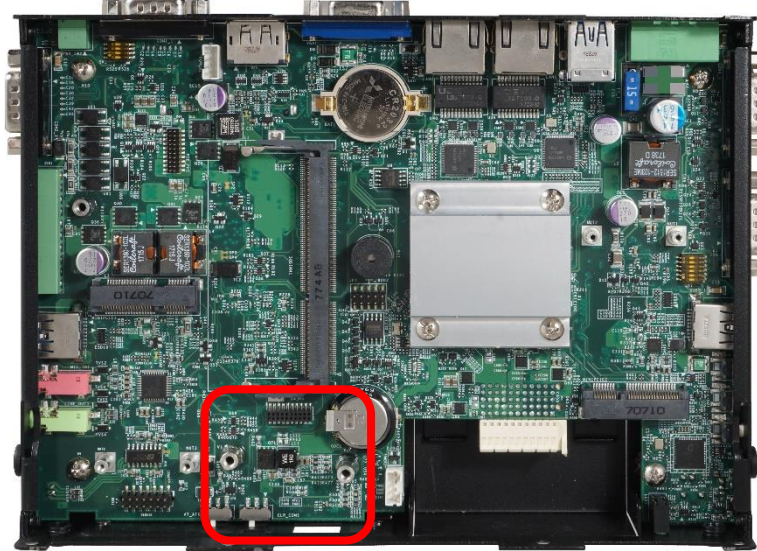

2. Insert CFM-IGN module vertically to the female connector on the system's mainboard, and fasten 2 screws to fix it.

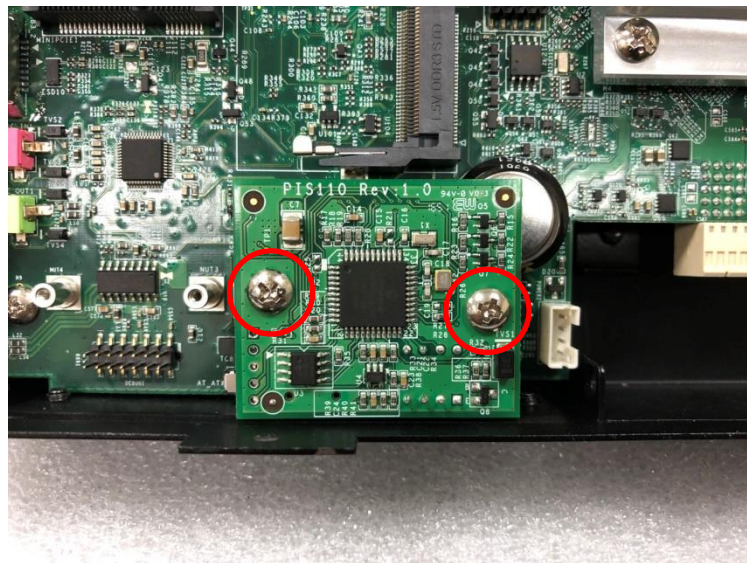

3. Loosen 2 screws on front panel to remove cover plate.





4. IGN function switch is at the front panel of the system.



## 6.3 Installing CFM-PoE Module

1. Locate the PoE connector on system motherboard as indicated.

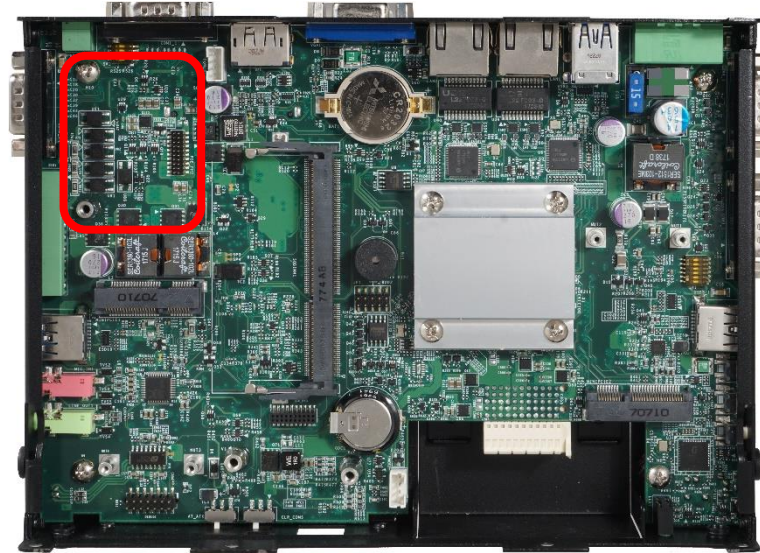

2. Insert the female connector of CFM-PoE module to the male connector on system motherboard.

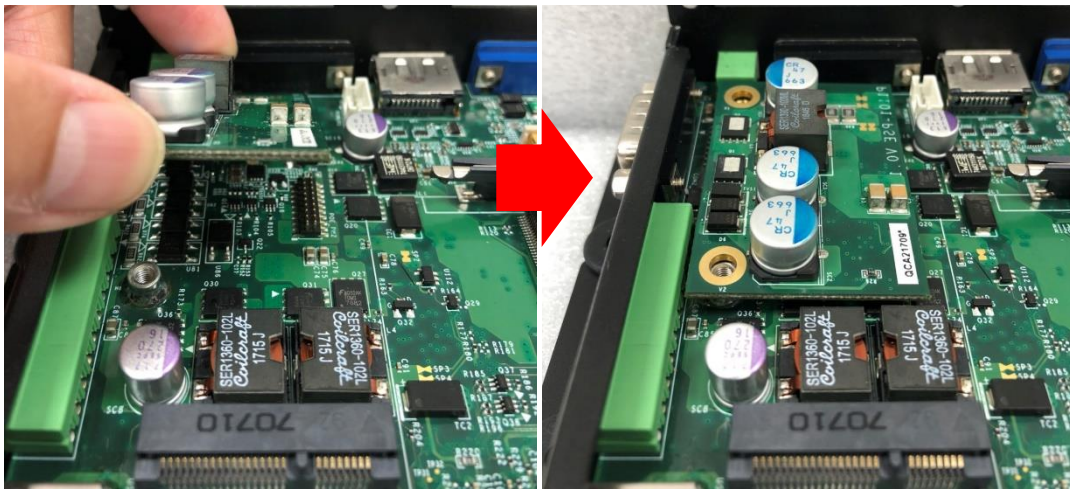

3. Turn over the heatsink and paste the thermal pad onto the marked by red squares.



**CAUTION**

**Before putting on the thermal block (in the next step), please make sure the protective film on the Thermal Pad has been removed!**

4. Paste the heatsink onto the CFM-PoE module carefully and fasten 2 screws to fix it.

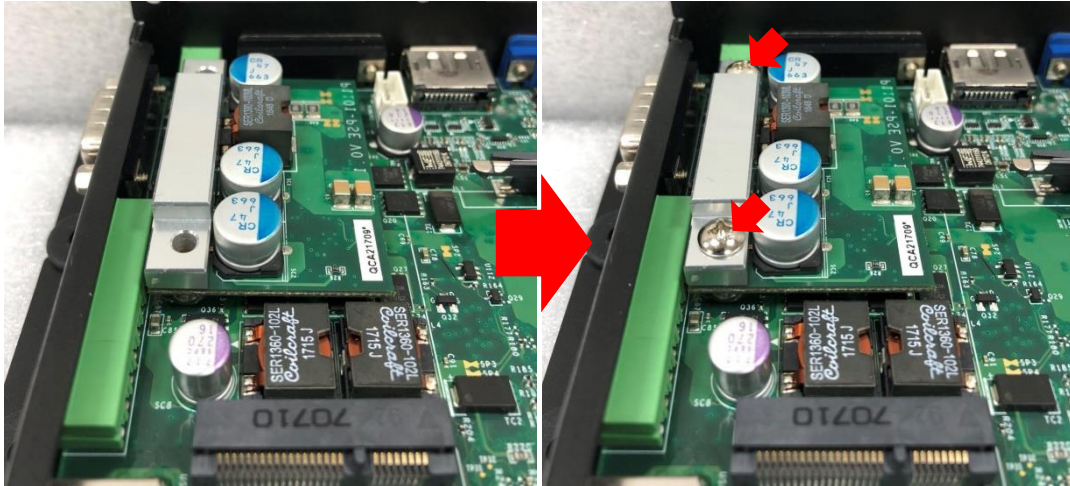

5. Paste the thermal pads onto the heatsink and coil carefully.

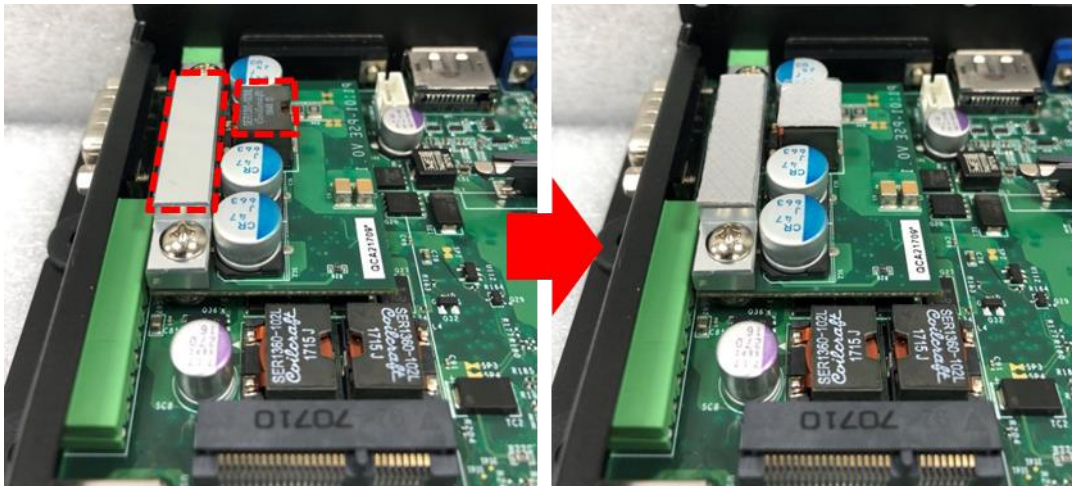

**CAUTION**

**Before assembling the system's chassis cover, please make sure the protective films on the Thermal Pads have been removed!**

6. When the system is power on, please note that the POE LED will light on if the POE module is properly installed.

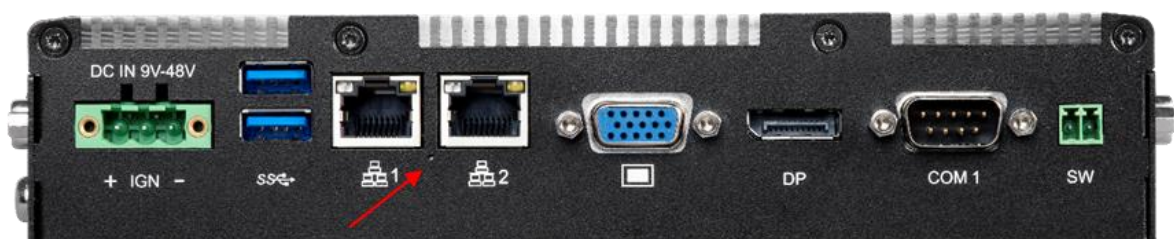

## 6.4 Installing VESA Mount

Before the installation of VESA mount, user need to follow the chapter 3.12 to disassemble the mounting brackets on the CO display module first.

This series supports VESA mounting that customer can mount system with panel complying with VESA 75mm and 100 mm standard for various usage. The 75mm VESA uses blue-circle-marked screw holes. The 100mm VESA uses red-circle-marked screw holes.

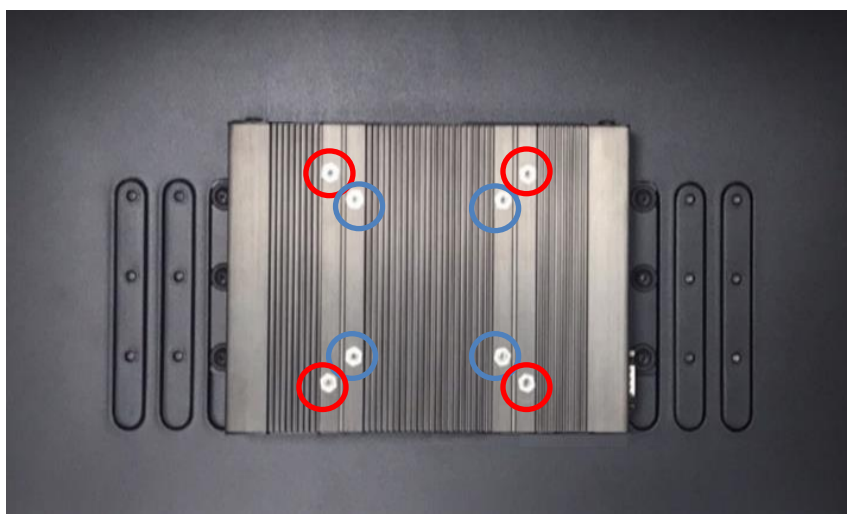

1. Put the VESA stand on, and align with the mounting holes.

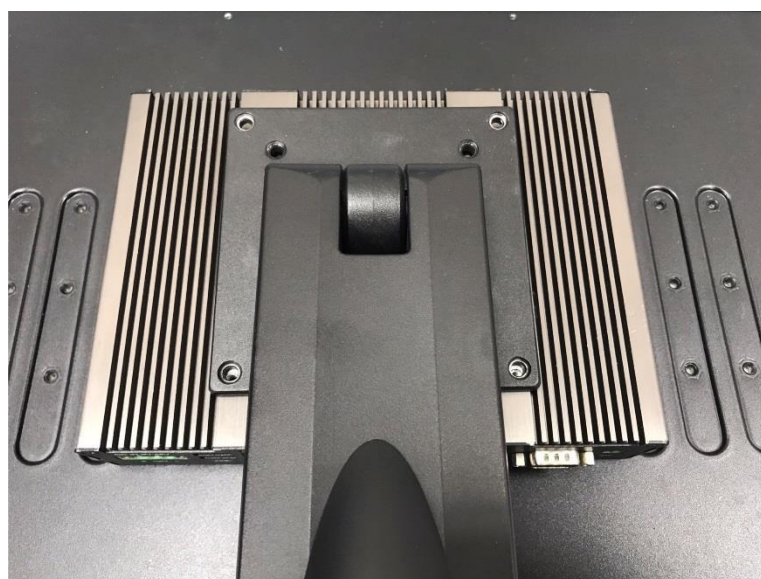

2. Fasten the VESA mount screws to complete the VESA mounting.

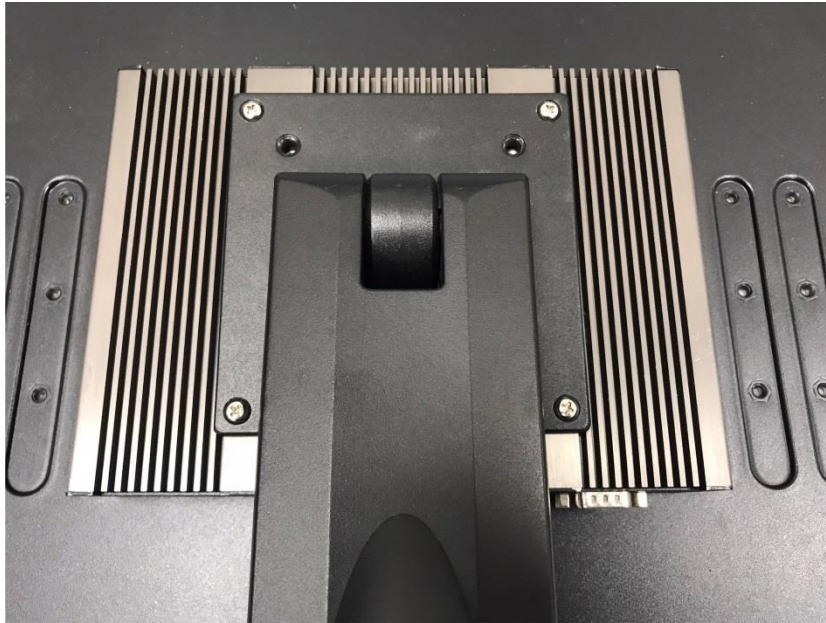

## 6.5 Installing Rack Mount

Before the installation of rack mount, user need to follow the chapter 3.12 to disassemble the mounting brackets on the CO display module first.

1. Locate the screw holes on the PC or monitor module.

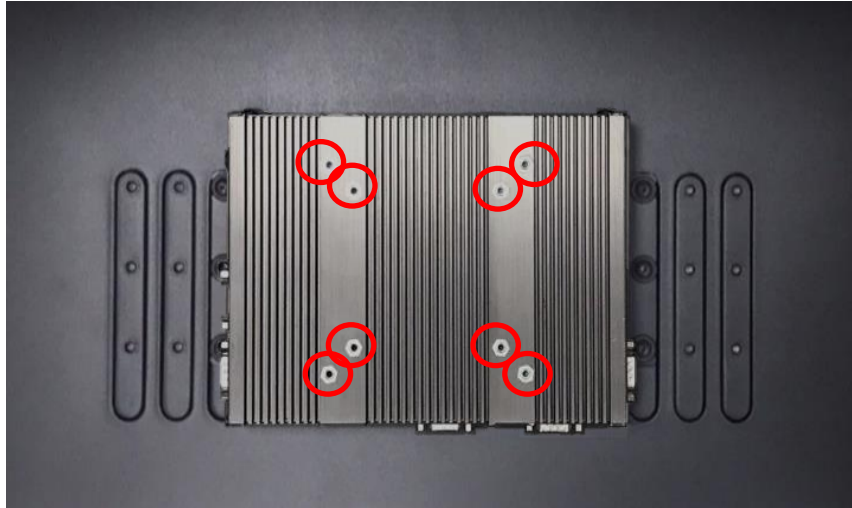

2. Put on the rack mount base and fasten the screws.

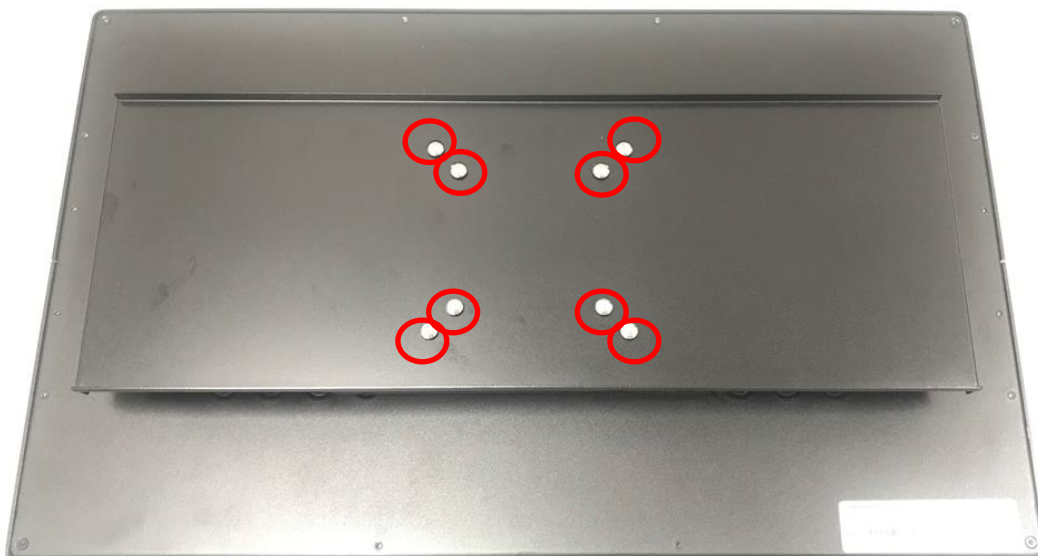

3. Assemble two rack mount brackets by fastening 4 screws (M5x6) at each side.

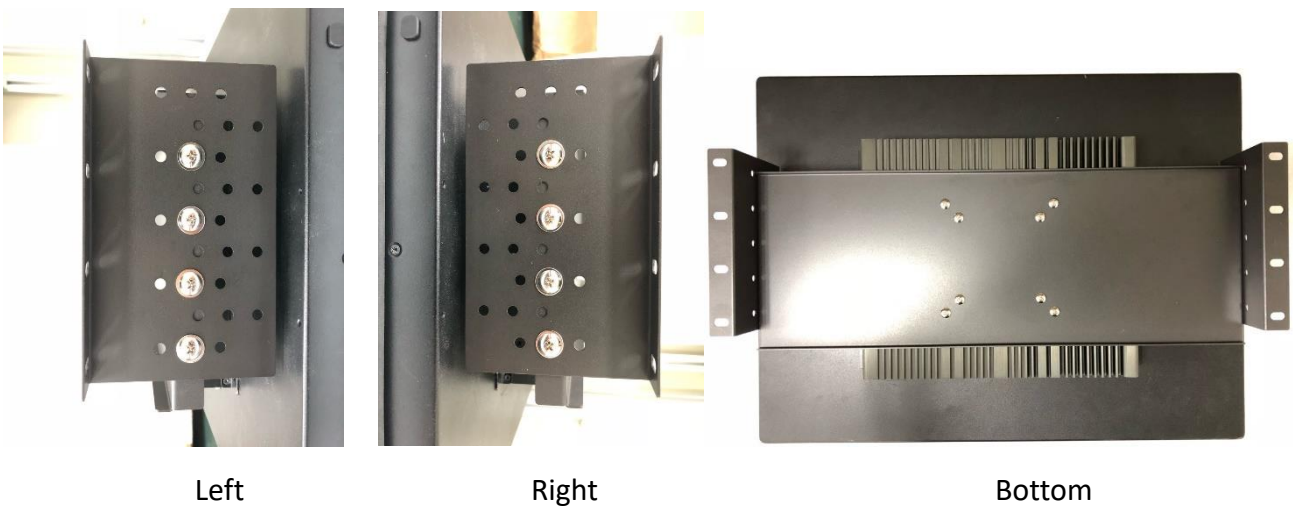
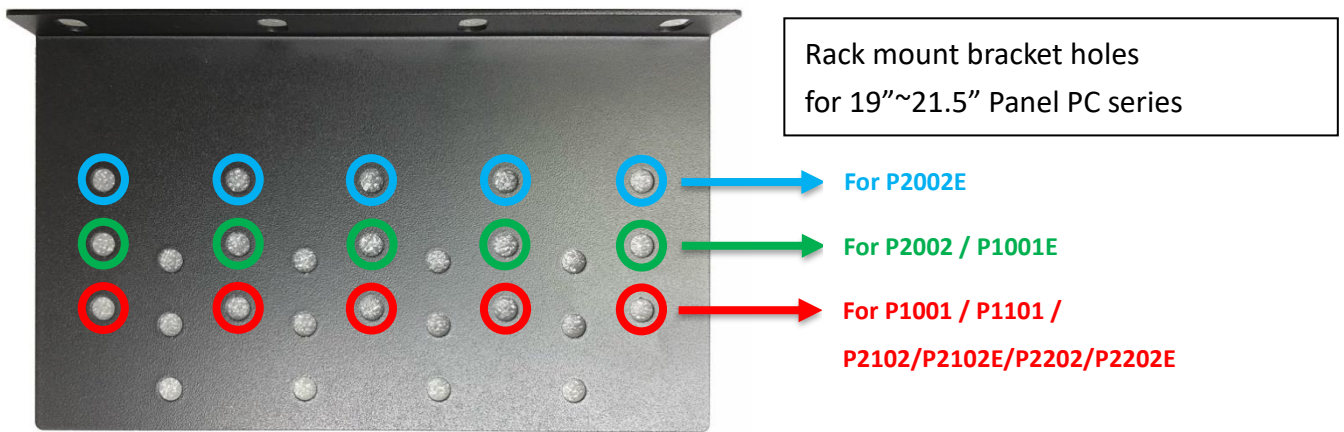

4. Assemble two rack mount brackets by fastening 4 screws (M5x12), flat washers and hex nuts at each side.



***cincoze***

© 2022 Cincoze Co., Ltd. All rights reserved.

The Cincoze logo is a registered trademark of Cincoze Co., Ltd.

All other logos appearing in this catalog are the intellectual property of the respective company, product, or organization associated with the logo.

All product specifications and information are subject to change without notice.