

cincoze

CO-100/P1001 Series

User Manual



Open Frame Panel PC

TFT LCD Open Frame Panel PC w/ Intel® Atom™ E3845
Quad Core, 4x USB, 2x COM, 1x VGA and 1x DisplayPort

Contents

Preface	5
Revision	5
Copyright Notice	5
Acknowledgement	5
Disclaimer.....	5
Declaration of Conformity.....	6
Product Warranty Statement	6
Technical Support and Assistance	8
Conventions Used in this Manual	8
Safety Precautions.....	9
Package Contents	10
Ordering Information	10
Chapter 1 Product Introductions	11
1.1 Overview	12
1.2 Highlights.....	12
1.3 Key Features	13
1.4 Hardware Specification	14
1.4.1 CO-119C-R10/P1001 Series	14
1.4.2 CO-W121C-R10/P1001 Series.....	19
1.5 System I/O.....	24
1.5.1 Front	24
1.5.2 Rear.....	24
1.5.3 Left.....	25
1.5.4 Right.....	25
Chapter 2 Jumpers, Switches & Connectors	26
2.1 Jumpers Settings	27
2.2 Location of the Jumpers/Switches/Connectors	27
2.2.1 Top View	27
2.2.2 Bottom View	28
2.3 Definition of Jumpers/Switches/Connectors	29
2.4 Definition of Jumpers	30
2.5 Definition of Switches	30
2.6 Definition of Connectors	31
Chapter 3 System Setup	37
3.1 Removing Top Cover.....	38
3.2 Installing Half Size Mini PCIe Card.....	39
3.3 Installing Full Size Mini PCIe Card	41

3.4 Installing Antenna(s)	42
3.5 Installing SO-DIMM Memory	44
3.6 Installing Top Cover	45
3.7 Installing SATA Hard Drive	46
3.8 Installing SIM Card	47
3.9 Installing CFast Card	48
3.10 Disassemble the CO Display Module	49
3.11 Installing Standard Mount.....	50
3.11.1 Fixing from front side.....	51
3.11.2 Fixing from rear side	52
3.12 Installing Flat Mount	53
3.12.1 Fixing from front side.....	58
3.12.2 Fixing from rear side	59
3.13 Disassemble the mounting brackets	60
Chapter 4 BIOS Setup.....	63
4.1 BIOS Introduction.....	64
4.2 Main Setup	65
4.2.1 System Date	65
4.2.2 System Time.....	65
4.3 Advanced Setup	65
4.3.1 ACPI Settings.....	66
4.3.2 Super IO Configuration	67
4.3.3 Hardware Monitor	68
4.3.4 Serial Port Console Redirection	69
4.3.5 CPU Configuration	69
4.3.6 Thermal Configuration.....	70
4.3.7 SATA Configuration.....	71
4.3.8 OS Selection	72
4.3.9 Compatibility Support Module Configuration	72
4.3.10 USB Configuration.....	73
4.4 Chipset Setup	75
4.4.1 North Bridge	75
4.4.2 South Bridge	77
4.5 Security Setup	79
4.5.1 Administrator Password	79
4.5.2 User Password	79
4.6 Boot Setup.....	80
4.6.1 Setup Prompt Timeout	80
4.6.2 Bootup NumLock State	80

4.6.3 Full Screen Logo Show	80
4.6.4 Fast Boot	80
4.6.5 UEFI Boot	80
4.7 Save & Exit.....	81
4.7.1 Save Changes and Reset	81
4.7.2 Discard Changes and Reset.....	81
4.7.3 Restore Defaults	81
4.7.4 Save as User Defaults.....	81
4.7.5 Restore User Defaults	81
Chapter 5 Product Application	82
5.1 Digital I/O (DIO) application	83
5.1.1 Digital I/O Programming Guide	83
5.2 Digital I/O (DIO) Hardware Specification	89
Chapter 6 Optional Accessories	91
6.1 Installing VESA Mount.....	92
6.2 Installing Rack Mount.....	94

Preface

Revision

Revision	Description	Date
1.00	First Released	2022/09/05
1.01	Correction Made	2023/04/14
1.02	Correction Made	2023/11/30

Copyright Notice

© 2022 by Cincoze Co., Ltd. All rights are reserved. No parts of this manual may be copied, modified, or reproduced in any form or by any means for commercial use without the prior written permission of Cincoze Co., Ltd. All information and specification provided in this manual are for reference only and remain subject to change without prior notice.

Acknowledgement

Cincoze is a registered trademark of Cincoze Co., Ltd. All registered trademarks and product names mentioned herein are used for identification purposes only and may be trademarks and/or registered trademarks of their respective owners.

Disclaimer

This manual is intended to be used as a practical and informative guide only and is subject to change without notice. It does not represent a commitment on the part of Cincoze. This product might include unintentional technical or typographical errors. Changes are periodically made to the information herein to correct such errors, and these changes are incorporated into new editions of the publication.

Declaration of Conformity



FCC

This equipment has been tested and found to comply with the limits for a Class A digital device, pursuant to Part 15 of the FCC Rules. These limits are designed to provide reasonable protection against harmful interference when the equipment is operated in a commercial environment. This equipment generates, uses, and can radiate radio frequency energy and, if not installed and used in accordance with the instruction manual, may cause harmful interference to radio communications. Operation of this equipment in a residential area is likely to cause harmful interference in which case the user will be required to correct the interference at his own expense.



CE

The product(s) described in this manual complies with all application European Union (CE) directives if it has a CE marking. For computer systems to remain CE compliant, only CE-compliant parts may be used. Maintaining CE compliance also requires proper cable and cabling techniques.

Product Warranty Statement

Warranty

Cincoze products are warranted by Cincoze Co., Ltd. to be free from defect in materials and workmanship for 2 years (2 Years for PC Module, 1 Year for Display Module) from the date of purchase by the original purchaser. During the warranty period, we shall, at our option, either repair or replace any product that proves to be defective under normal operation. Defects, malfunctions, or failures of the warranted product caused by damage resulting from natural disasters (such as by lightning, flood, earthquake, etc.), environmental and atmospheric disturbances, other external forces such as power line disturbances, plugging the board in under power, or incorrect cabling, and damage caused by misuse, abuse, and unauthorized alteration or repair, and the product in question is either software, or an expendable item (such as a fuse, battery, etc.), are not warranted.

RMA

Before sending your product in, you will need to fill in Cincoze RMA Request Form and obtain an RMA number from us. Our staff is available at any time to provide you with the most friendly and immediate service.

■ RMA Instruction

- Customers must fill in Cincoze Return Merchandise Authorization (RMA) Request Form and obtain an RMA number prior to returning a defective product to Cincoze for service.
- Customers must collect all the information about the problems encountered and note anything abnormal and describe the problems on the "Cincoze Service Form" for the RMA number apply process.
- Charges may be incurred for certain repairs. Cincoze will charge for repairs to products whose warranty period has expired. Cincoze will also charge for repairs to products if the damage resulted from acts of God, environmental or atmospheric disturbances, or other external forces through misuse, abuse, or unauthorized alteration or repair. If charges will be incurred for a repair, Cincoze lists all charges, and will wait for customer's approval before performing the repair.
- Customers agree to ensure the product or assume the risk of loss or damage during transit, to prepay shipping charges, and to use the original shipping container or equivalent.
- Customers can be sent back the faulty products with or without accessories (manuals, cable, etc.) and any components from the system. If the components were suspected as part of the problems, please note clearly which components are included. Otherwise, Cincoze is not responsible for the devices/parts.
- Repaired items will be shipped along with a "Repair Report" detailing the findings and actions taken.

Limitation of Liability

Cincoze' liability arising out of the manufacture, sale, or supplying of the product and its use, whether based on warranty, contract, negligence, product liability, or otherwise, shall not exceed the original selling price of the product. The remedies provided herein are the customer's sole and exclusive remedies. In no event shall Cincoze be liable for direct, indirect, special or consequential damages whether based on contract of any other legal theory.

Technical Support and Assistance

1. Visit the Cincoze website at www.cincoze.com where you can find the latest information about the product.
2. Contact your distributor or our technical support team or sales representative for technical support if you need additional assistance. Please have following information ready before you call:
 - Product name and serial number
 - Description of your peripheral attachments
 - Description of your software (operating system, version, application software, etc.)
 - A complete description of the problem
 - The exact wording of any error messages

Conventions Used in this Manual



WARNING

This indication alerts operators to an operation that, if not strictly observed, may result in severe injury.



CAUTION

This indication alerts operators to an operation that, if not strictly observed, may result in safety hazards to personnel or damage to equipment.



NOTE

This indication provides additional information to complete a task easily.

Safety Precautions

Before installing and using this device, please note the following precautions.

1. Read these safety instructions carefully.
2. Keep this User's Manual for future reference.
3. Disconnect this equipment from any AC outlet before cleaning.
4. For plug-in equipment, the power outlet socket must be located near the equipment and must be easily accessible.
5. Keep this equipment away from humidity.
6. Put this equipment on a reliable surface during installation. Dropping it or letting it fall may cause damage.
7. Make sure the voltage of the power source is correct before connecting the equipment to the power outlet.
8. Use a power cord that has been approved for using with the product and that it matches the voltage and current marked on the product's electrical range label. The voltage and current rating of the cord must be greater than the voltage and current rating marked on the product.
9. Position the power cord so that people cannot step on it. Do not place anything over the power cord.
10. All cautions and warnings on the equipment should be noted.
11. If the equipment is not used for a long time, disconnect it from the power source to avoid damage by transient overvoltage.
12. Never pour any liquid into an opening. This may cause fire or electrical shock.
13. Never open the equipment. For safety reasons, the equipment should be opened only by qualified service personnel.

If one of the following situations arises, get the equipment checked by service personnel:

- The power cord or plug is damaged.
 - Liquid has penetrated into the equipment.
 - The equipment has been exposed to moisture.
 - The equipment does not work well, or you cannot get it work according to the user's manual.
 - The equipment has been dropped and damaged.
 - The equipment has obvious signs of breakage.
14. CAUTION: Danger of explosion if battery is incorrectly replaced. Replace only with the same or equivalent type recommended by the manufacturer.
 15. Equipment intended only for use in a RESTRICTED ACCESS AREA.
 16. Ensure to connect the power cord of power adapter to a socket-outlet with earthing connection.
 17. Dispose of used battery promptly. Keep away from children. Do not disassemble and do not dispose of in fire.

Package Contents

Before installation, please ensure all the items listed in the following table are included in the package.

Item	Description	Q'ty
1	CO-100/P1001 Series Panel PC	1
2	DIO Terminal Block Connector (Female)	1
3	Power Terminal Block Connector (Female)	1
4	HDD Screw Pack	1
5	Mini PCIe Screw Pack	1

Note: Notify your sales representative if any of the above items are missing or damaged.

Ordering Information

Available Models

Model No.	Product Description
CO-119C-R10/P1001-R10	19" TFT-LCD SXGA 5:4 Open Frame Display Modular Panel PC with Intel Atom E3845 Quad Core Processor and P-Cap. Touch
CO-119C-R10/P1001E-R10	19" TFT-LCD SXGA 5:4 Open Frame Display Modular and Expandable Panel PC with Intel Atom E3845 Quad Core Processor and P-Cap. Touch
CO-W121C-R10/P1001-R10	21.5" TFT-LCD Full HD 16:9 Open Frame Display Module with Projected Capacitive Touch and Intel® Atom™ E3845 Quad Core PC Module, 4x USB, 2x COM, 1x VGA, 1x DisplayPort
CO-W121C-R10/P1001E-R10	21.5" TFT-LCD Full HD 16:9 Open Frame Display Module with Projected Capacitive Touch and Intel® Atom™ E3845 Quad Core PC Module, 4x USB, 2x COM, 1x VGA, 1x DisplayPort, 2x Universal Brackets



Chapter 1

Product Introductions

1.1 Overview

Cincoze power efficient open frame modular panel PCs (CO-100/P1001 Series) support Intel® Atom® and Pentium® processors, and multiple displays. Native I/O ports include LAN, USB, COM, and DIO, offering expansion functions to meet different application needs. The integrated structure, exclusive adjustable mounting bracket, and support for various mounting methods enable a perfect fit in cabinets of different materials and thicknesses. The robust design also meets the application needs of harsh industrial environments.

1.2 Highlights

Power Efficient & Multi-Display

Powered by Intel® Atom® processor with support for multiple displays.



Rich I/O for Flexible Expansion

Native I/O ports include LAN, USB, COM, DIO, Mini-PCle, and SIM slot for additional expansion functions to meet different application needs.

Patented CDS Technology

The patented CDS (Convertible Display System) technology makes maintenance easy and offers flexibility for future upgrades. To upgrade the panel size, replace the display module, or to upgrade the system performance, replace the computer module.

Patent No. M482908

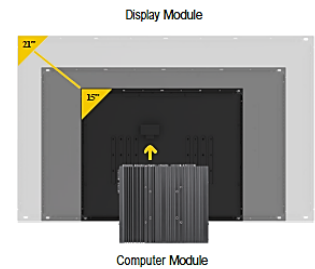



Flexible Design and Easy Installation

Exclusive adjustable mounting bracket with thickness adjustment setting and two panel-locking methods (panel or boss type) make modular panel PC easier and more convenient to integrate into industrial machinery.

Patent No. I802427, D224544, D224545

Integrated Structure

As standard, the open frame modular panel pc can be deployed in equipment machines, but remove the mounting bracket and it becomes a standalone panel pc for use with a VESA mount or in a 19" rack.



Strong, Reliable and Durable

Meets the requirements for HMI applications in harsh industrial environments: IP65 waterproof and dustproof front panel, fanless, wide temperature (0–70°C), and wide voltage (9–48 VDC).

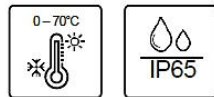

1.3 Key Features

- TFT-LCD with Projected Capacitive Touch
- Onboard Intel® Atom™ E3845 Processor Quad Core, 1.91GHz
- 1x DDR3L SO-DIMM max. up to 8GB
- Designed with Adjustable Mounting Bracket
- Support Flat / Standard / VESA / Rack Mount
- Front Panel IP65 Compliant
- Wide Operating Temperature
- Cincoze Patent CDS Technology Support

1.4 Hardware Specification

1.4.1 CO-119C-R10/P1001 Series

Model Name	CO-119C
Display	
LCD Size	• 19" (5:4)
Resolution	• 1280 x 1024
Brightness	• 350 cd/m ²
Contract Ratio	• 1000:1
LCD Color	• 16.7M
Pixel Pitch	• 0.294(H) x 0.294(V)
Viewing Angle	• 170 (H) / 160 (V)
Backlight MTBF	• 50,000 hrs (LED Backlight)
Touchscreen	
Touchscreen Type	• Projected Capacitive Touch
Physical	
Dimension (WxDxH)	• 472.8 x 397.5 x 63 mm
Weight	• 6.91KG
Construction	• One-piece and Slim Bezel Design
Mounting Type	• Flat / Standard / VESA / Rack Mount
Mounting Bracket	• Pre-installed Mounting Bracket with Adjustable Design (Support 11 different stages of adjustment)
Protection	
Ingress Protection	• Front Panel IP65 Compliant * According to IEC60529
Environment	
Operating Temperature	• 0°C to 50°C (with Industrial Grade peripherals; Ambient with air flow)
Storage Temperature	• -20°C to 60°C
Humidity	• 80% RH @ 50°C (non-condensing)
EMC	• CE, UKCA, FCC, ICES-003 Class A
EMI	• CISPR 32 Conducted & Radiated: Class A • EN/BS EN 55032 Conducted & Radiated: Class A • EN/BS EN IEC 61000-3-2 Harmonic current emissions: Class A • EN/BS EN61000-3-3 Voltage fluctuations & flicker • FCC 47 CFR Part 15B, ICES-003 Conducted & Radiated: Class A
EMS	• EN/IEC 61000-4-2 ESD: Contact: 4 kV; Air: 8 kV • EN/IEC 61000-4-3 RS: 80 MHz to 1000 MHz: 3 V/m

	<ul style="list-style-type: none"> • EN/IEC 61000-4-4 EFT: AC Power: 1 kV; DC Power: 0.5 kV; Signal: 0.5 kV • EN/IEC 61000-4-5 Surges: AC Power: 2 kV; Signal: 1 kV • EN/IEC 61000-4-6 CS: 3V • EN/IEC 61000-4-8 PFMF: 50 Hz, 1A/m • EN/IEC 61000-4-11 Voltage Dips & Voltage Interruptions: 0.5 cycles at 50 Hz
--	---

Model Name	P1001	P1001E
System		
Processor	• Onboard Intel® Atom™ Processor E3845 Quad Core, 1.91 GHz	
Memory	<ul style="list-style-type: none"> • 1x DDR3L 1066/1333 MHz SO-DIMM Socket (un-buffered and non-ECC) • Support up to 8 GB 	
BIOS	• AMI 64Mbit SPI BIOS	
Graphics		
VGA	• 1x VGA Connector(1920x1080@60Hz)	
DP	• 1x DisplayPort Connector (1920x1080@60Hz)	
Audio		
Line-out	• 1x Line-out, Phone Jack 3.5mm	
Mic-in	• 1x Mic-in, Phone Jack 3.5mm	
I/O		
LAN	<ul style="list-style-type: none"> • 2x GbE LAN (Supports WoL, Teaming, Jumbo Frame & PXE), RJ45 - GbE1: Intel® I210 - GbE2: Intel® I210 	
USB	• 1x USB 3.2 Gen1 (Type A), 3x USB 2.0 (Type A)	
COM	• 2x DB9 for COM1~2, Support RS232/422/485 with Auto Flow Control	
DIO	• 8x Digital I/O (4in/4out)	
Power Mode Switch	• 1x AT/ATX Mode Switch	
Power Switch	• 1x Power Switch	
Reset Button	• 1x Reset Button	
Storage		
SSD/HDD	• 1x 2.5" SATA HDD Bay	
CFast	• 1x External CFast Socket	
SIM Card	• 1x External SIM Card Socket	
Expansion		
Mini PCI Express	• 1x Full-size Mini PCIe Socket for Wi-Fi/GSM/Expansion Module	
I/O Brackets		• 2x Universal I/O Brackets
Other Function		
Watchdog Timer	• Software Programmable Supports 256 Levels System Reset	
Internal Speaker	• AMP 2W + 2W (Internal Speaker)	

OSD Function	• LCD On/O, Brightness Up, Brightness Down	
Power		
AT/ATX Power	• Support AT, ATX Mode	
Power Input	• 1x 3-pin Terminal Block Connector with Power Input 9-48VDC	
Power Adapter (Optional)	• 1x Optional AC/DC 12V/5A, 60W Power Adapter	
Physical		
Dimension(W x D x H)	• 204.5 X 149 X 37.5 mm	• 204.5 x 150 x 60 mm
Weight Information	• 1.34kg	• 1.54kg
Mechanical Construction	• Extruded Aluminum with Heavy Duty Metal	
Mounting	• Wall / VESA / CDS Mounting	
Reliability & Protection		
Reverse Power Input	• Yes	
Over Voltage Protection	<ul style="list-style-type: none"> • Protection Range: 51-58V • Protection Type: shut down operating voltage, • re-power on at the present level to recover 	
Over Current Protection	• 20A	
Operating System		
Microsoft® Windows®	<ul style="list-style-type: none"> • Windows®10, Windows® 8, Windows® 7 • Windows® Embedded 8 Standard, Windows® Embedded Standard 7 	
Linux	• Supports by project	
Environment		
Operating Temperature	• Ambient with Air Flow: -20°C to 70°C (with Industrial Grade Peripherals)	
Storage Temperature	• -30°C to 85°C	
Relative humidity	• 10%~95% (non-condensing)	
Shock	• Operating, 15 Grms, Half-sine 11 ms Duration (w/ SSD, according to IEC60068-2-27)	
Vibration	• Operating, 1 Grms, 5-500 Hz, 3 Axes (w/ SSD, according to IEC60068-2-64)	
EMC	• CE, UKCA, FCC, ICES-003 Class A	
EMI	<ul style="list-style-type: none"> • CISPR 32 Conducted & Radiated: Class A • EN/BS EN 55032 Conducted & Radiated: Class A • EN/BS EN IEC 61000-3-2 Harmonic current emissions: Class A • EN/BS EN61000-3-3 Voltage fluctuations & flicker • FCC 47 CFR Part 15B, ICES-003 Conducted & Radiated: Class A 	
EMS	<ul style="list-style-type: none"> • EN/IEC 61000-4-2 ESD: Contact: 4 kV; Air: 8 kV • EN/IEC 61000-4-3 RS: 80 MHz to 1000 MHz: 3 V/m • EN/IEC 61000-4-4 EFT: AC Power: 1 kV; DC Power: 0.5 kV; Signal: 0.5 kV • EN/IEC 61000-4-5 Surges: AC Power: 2 kV; Signal: 1 kV • EN/IEC 61000-4-6 CS: 3V 	

- | | |
|--|--|
| | <ul style="list-style-type: none">• EN/IEC 61000-4-8 PFMF: 50 Hz, 1A/m• EN/IEC 61000-4-11 Voltage Dips & Voltage Interruptions: 0.5 cycles at 50 Hz |
|--|--|

** Product Specifications and features are for reference only and are subject to change without prior notice. For more information, please refer to the latest product datasheet from Cincoze's website.*

Dimension

CO-119C/P1001

Unit: mm

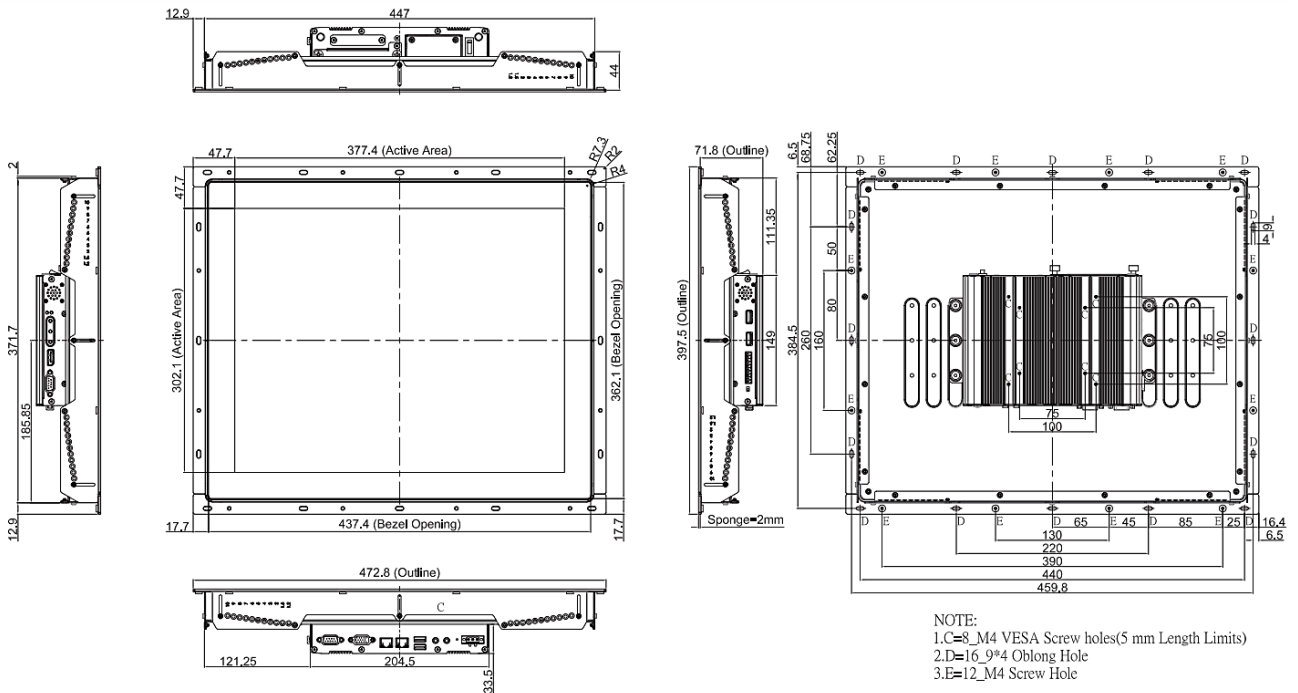

CO-119C/P1001E

Unit: mm

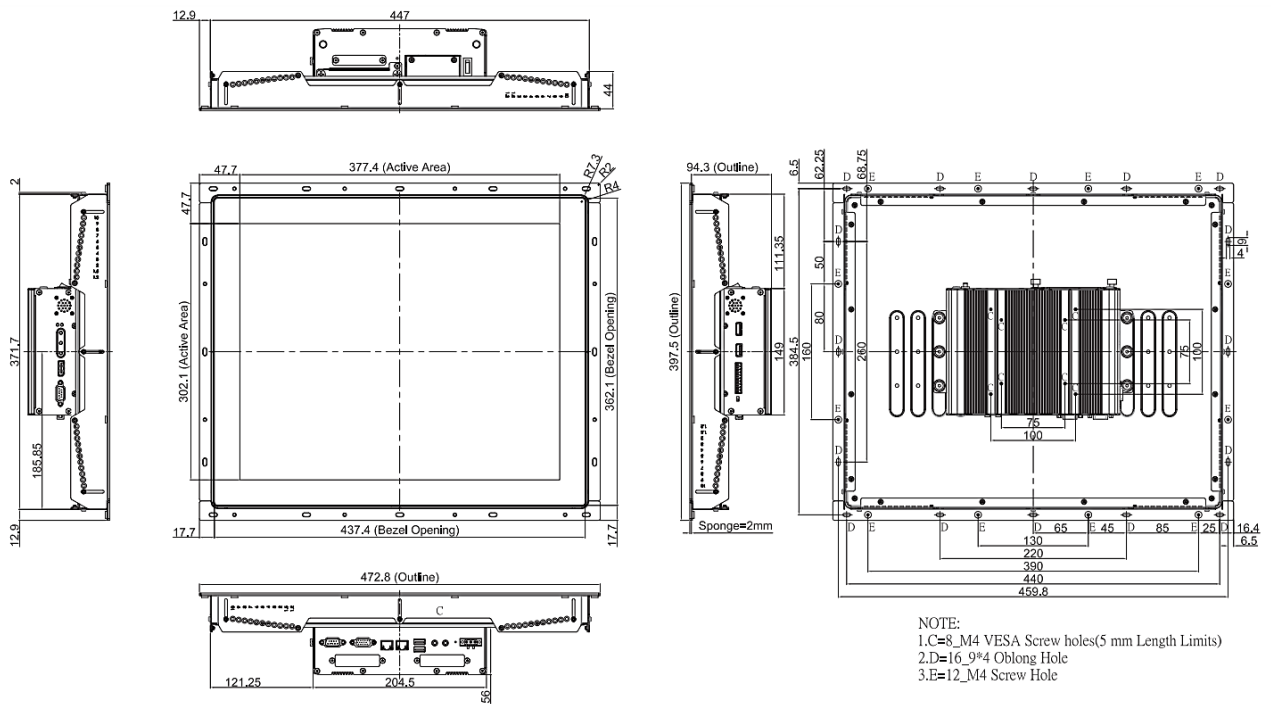

1.4.2 CO-W121C-R10/P1001 Series

Model Name	CO-W121C
Display	
LCD Size	• 21.5" (16:9)
Resolution	• 1920 x 1080
Brightness	• 300 cd/m2
Contract Ratio	• 5000:1
LCD Color	• 16.7M
Pixel Pitch	• 0.24825(H) x 0.24825(V)
Viewing Angle	• 178 (H) / 178 (V)
Backlight MTBF	• 50,000 hrs
Touchscreen	
Touchscreen Type	• Projected Capacitive Touch
Physical	
Dimension (WxDxH)	• 550 x 343.7 x 63.3 mm
Weight	• 7.16KG
Construction	• One-piece and Slim Bezel Design
Mounting Type	• Flat / Standard / VESA / Rack Mount
Mounting Bracket	• Pre-installed Mounting Bracket with Adjustable Design (Support 11 different stages of adjustment)
Protection	
Ingress Protection	• Front Panel IP65 Compliant * According to IEC60529
Environment	
Operating Temperature	• 0°C to 60°C (with Industrial Grade peripherals; Ambient with air flow)
Storage Temperature	• -20°C to 60°C
Humidity	• 80% RH @ 50°C (non-condensing)
EMC	• CE, UKCA, FCC, ICES-003 Class A
EMI	• CISPR 32 Conducted & Radiated: Class A • EN/BS EN 55032 Conducted & Radiated: Class A • EN/BS EN IEC 61000-3-2 Harmonic current emissions: Class A • EN/BS EN61000-3-3 Voltage fluctuations & flicker • FCC 47 CFR Part 15B, ICES-003 Conducted & Radiated: Class A
EMS	• EN/IEC 61000-4-2 ESD: Contact: 4 kV; Air: 8 kV • EN/IEC 61000-4-3 RS: 80 MHz to 1000 MHz: 3 V/m • EN/IEC 61000-4-4 EFT: AC Power: 1 kV; DC Power: 0.5 kV; Signal: 0.5 kV • EN/IEC 61000-4-5 Surges: AC Power: 2 kV; Signal: 1 kV

	<ul style="list-style-type: none"> • EN/IEC 61000-4-6 CS: 3V • EN/IEC 61000-4-8 PFMF: 50 Hz, 1A/m • EN/IEC 61000-4-11 Voltage Dips & Voltage Interruptions: 0.5 cycles at 50 Hz
Safety	<ul style="list-style-type: none"> • UL, cUL, CB, IEC, EN 62368-1

Model Name	P1001	P1001E
System		
Processor	<ul style="list-style-type: none"> • Onboard Intel® Atom™ Processor E3845 Quad Core, 1.91 GHz 	
Memory	<ul style="list-style-type: none"> • 1x DDR3L 1066/1333 MHz SO-DIMM Socket (un-buffered and non-ECC) • Support up to 8 GB 	
BIOS	<ul style="list-style-type: none"> • AMI 64Mbit SPI BIOS 	
Graphics		
VGA	<ul style="list-style-type: none"> • 1x VGA Connector(1920x1080@60Hz) 	
DP	<ul style="list-style-type: none"> • 1x DisplayPort Connector (1920x1080@60Hz) 	
Audio		
Line-out	<ul style="list-style-type: none"> • 1x Line-out, Phone Jack 3.5mm 	
Mic-in	<ul style="list-style-type: none"> • 1x Mic-in, Phone Jack 3.5mm 	
I/O		
LAN	<ul style="list-style-type: none"> • 2x GbE LAN (Supports WoL, Teaming, Jumbo Frame & PXE), RJ45 - GbE1: Intel® I210 - GbE2: Intel® I210 	
USB	<ul style="list-style-type: none"> • 1x USB 3.2 Gen1 (Type A), 3x USB 2.0 (Type A) 	
COM	<ul style="list-style-type: none"> • 2x DB9 for COM1~2, Support RS232/422/485 with Auto Flow Control 	
DIO	<ul style="list-style-type: none"> • 8x Digital I/O (4in/4out) 	
Power Mode Switch	<ul style="list-style-type: none"> • 1x AT/ATX Mode Switch 	
Power Switch	<ul style="list-style-type: none"> • 1x Power Switch 	
Reset Button	<ul style="list-style-type: none"> • 1x Reset Button 	
Storage		
SSD/HDD	<ul style="list-style-type: none"> • 1x 2.5" SATA HDD Bay 	
CFast	<ul style="list-style-type: none"> • 1x External CFast Socket 	
SIM Card	<ul style="list-style-type: none"> • 1x External SIM Card Socket 	
Expansion		
Mini PCI Express	<ul style="list-style-type: none"> • 1x Full-size Mini PCIe Socket for Wi-Fi/GSM/Expansion Module 	
I/O Brackets		<ul style="list-style-type: none"> • 2x Universal I/O Brackets
Other Function		
Watchdog Timer	<ul style="list-style-type: none"> • Software Programmable Supports 256 Levels System Reset 	
Internal Speaker	<ul style="list-style-type: none"> • AMP 2W + 2W (Internal Speaker) 	
OSD Function	<ul style="list-style-type: none"> • LCD On/O, Brightness Up, Brightness Down 	

Power		
AT/ATX Power	<ul style="list-style-type: none"> • Support AT, ATX Mode 	
Power Input	<ul style="list-style-type: none"> • 1x 3-pin Terminal Block Connector with Power Input 9-48VDC 	
Power Adapter (Optional)	<ul style="list-style-type: none"> • 1x Optional AC/DC 12V/5A, 60W Power Adapter 	
Physical		
Dimension(W x D x H)	<ul style="list-style-type: none"> • 204.5 X 149 X 37.5 mm 	<ul style="list-style-type: none"> • 204.5 x 150 x 60 mm
Weight Information	<ul style="list-style-type: none"> • 1.34kg 	<ul style="list-style-type: none"> • 1.54kg
Mechanical Construction	<ul style="list-style-type: none"> • Extruded Aluminum with Heavy Duty Metal 	
Mounting	<ul style="list-style-type: none"> • Wall / VESA / CDS Mounting 	
Reliability & Protection		
Reverse Power Input	<ul style="list-style-type: none"> • Yes 	
Over Voltage Protection	<ul style="list-style-type: none"> • Protection Range: 51-58V • Protection Type: shut down operating voltage, • re-power on at the present level to recover 	
Over Current Protection	<ul style="list-style-type: none"> • 20A 	
Operating System		
Microsoft® Windows®	<ul style="list-style-type: none"> • Windows®10, Windows® 8, Windows® 7 • Windows® Embedded 8 Standard, Windows® Embedded Standard 7 	
Linux	<ul style="list-style-type: none"> • Supports by project 	
Environment		
Operating Temperature	<ul style="list-style-type: none"> • Ambient with Air Flow: -20°C to 70°C (with Industrial Grade Peripherals) 	
Storage Temperature	<ul style="list-style-type: none"> • -30°C to 85°C 	
Relative humidity	<ul style="list-style-type: none"> • 10%~95% (non-condensing) 	
Shock	<ul style="list-style-type: none"> • Operating, 15 Grms, Half-sine 11 ms Duration (w/ SSD, according to IEC60068-2-27) 	
Vibration	<ul style="list-style-type: none"> • Operating, 1 Grms, 5-500 Hz, 3 Axes (w/ SSD, according to IEC60068-2-64) 	
EMC	<ul style="list-style-type: none"> • CE, UKCA, FCC, ICES-003 Class A 	
EMI	<ul style="list-style-type: none"> • CISPR 32 Conducted & Radiated: Class A • EN/BS EN 55032 Conducted & Radiated: Class A • EN/BS EN IEC 61000-3-2 Harmonic current emissions: Class A • EN/BS EN61000-3-3 Voltage fluctuations & flicker • FCC 47 CFR Part 15B, ICES-003 Conducted & Radiated: Class A 	
EMS	<ul style="list-style-type: none"> • EN/IEC 61000-4-2 ESD: Contact: 4 kV; Air: 8 kV • EN/IEC 61000-4-3 RS: 80 MHz to 1000 MHz: 3 V/m • EN/IEC 61000-4-4 EFT: AC Power: 1 kV; DC Power: 0.5 kV; Signal: 0.5 kV • EN/IEC 61000-4-5 Surges: AC Power: 2 kV; Signal: 1 kV • EN/IEC 61000-4-6 CS: 3V • EN/IEC 61000-4-8 PFMF: 50 Hz, 1A/m 	

- | | |
|--|---|
| | <ul style="list-style-type: none">• EN/IEC 61000-4-11 Voltage Dips & Voltage Interruptions: 0.5 cycles at 50 Hz |
|--|---|

** Product Specifications and features are for reference only and are subject to change without prior notice. For more information, please refer to the latest product datasheet from Cincoze's website.*

Dimension

CO-W121C/P1001

Unit: mm

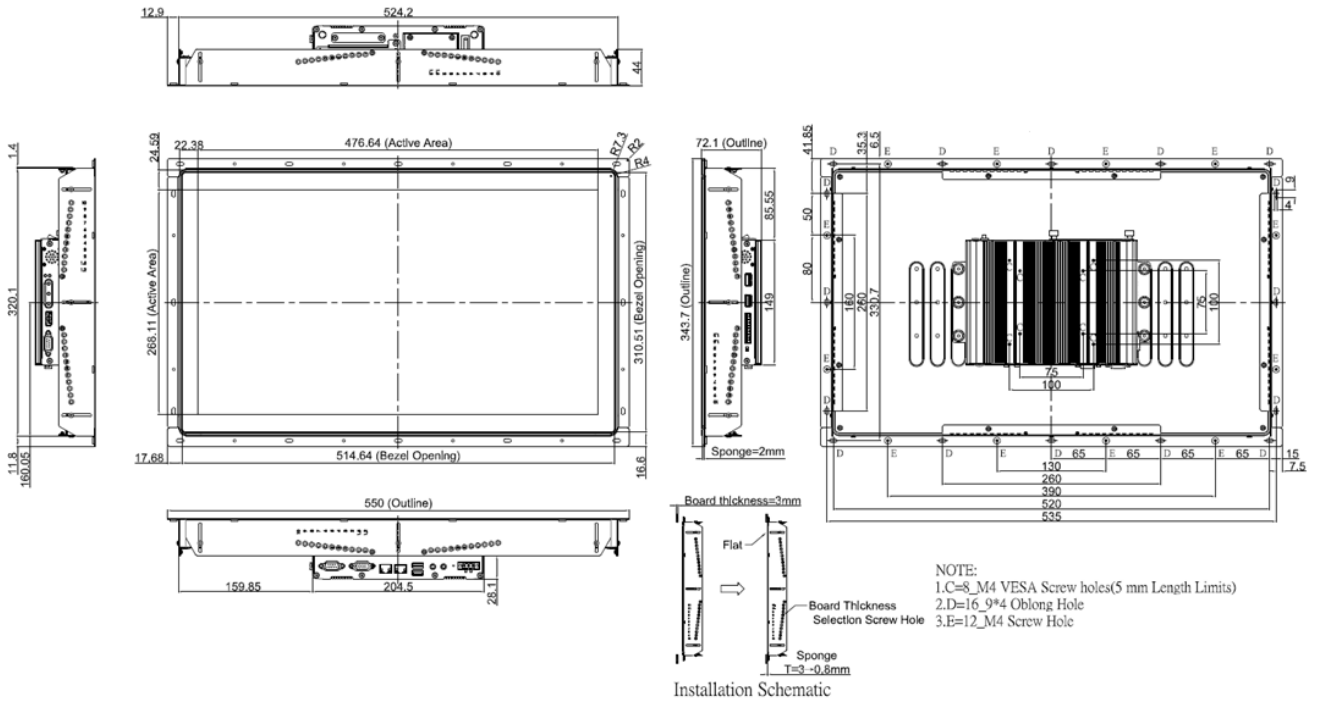

CO-W121C/P1001E

Unit: mm

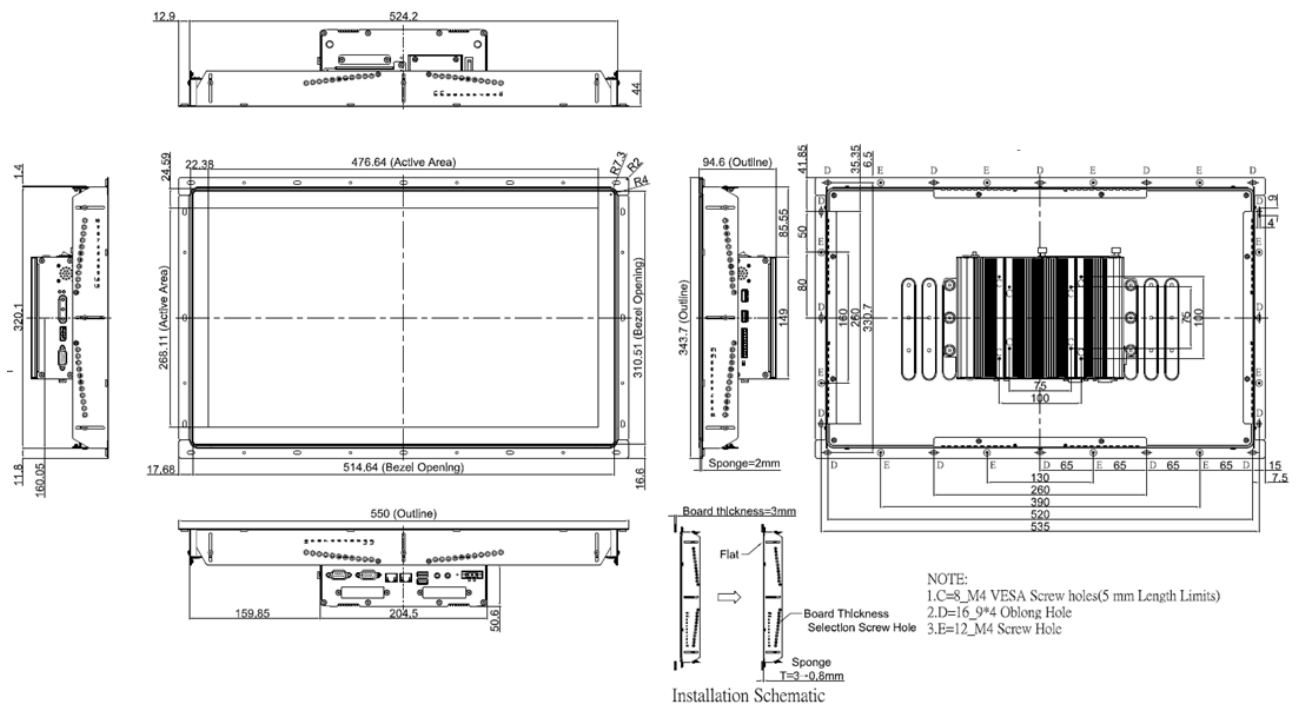

1.5 System I/O

1.5.1 Front

Antenna

Used to connect an antenna for optional wireless module

CFast / SIM card

Used to insert a CFast card and SIM card

Removable HDD Bay

Used to insert a 2.5" HDD or SSD

Power On/Off

Used to power-on or power-off the system

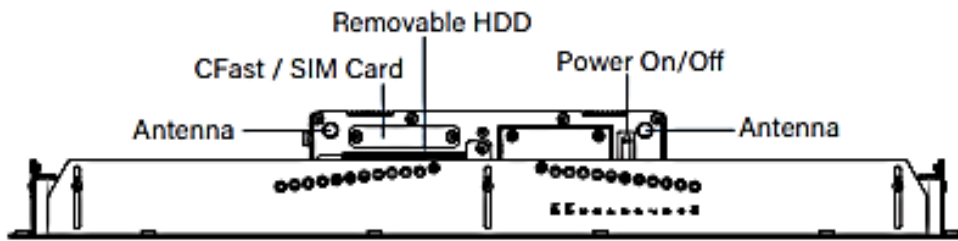

1.5.2 Rear

DC IN

Used to plug a DC power input with terminal block

Reset

Used to reset the system

Mic-in

Used to connect a microphone

Line-out

Used to connect an external speaker

USB 2.0

Used to connect USB 2.0 device

LAN1, LAN2

Used to connect the system to a local area network

VGA

Used to connect an analog VGA monitor

COM1

COM1 supports RS232/422/485 serial device

Expansion

2x Universal I/O Brackets (P1001E only)

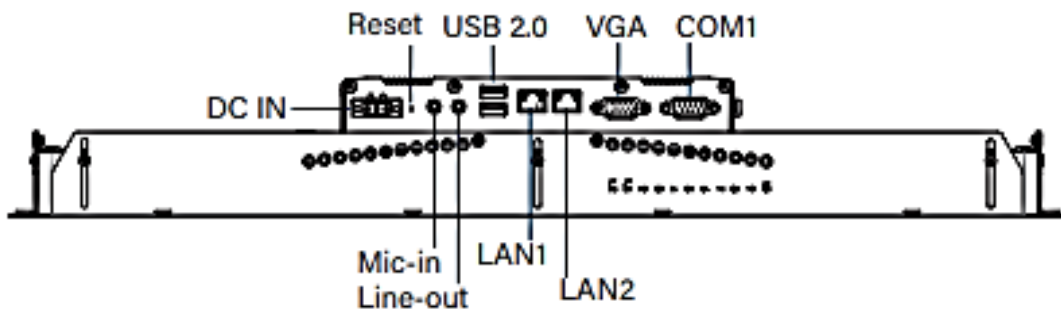

1.5.3 Left

USB 3.0

Used to connect USB 3.0/2.0 device

USB 2.0

Used to connect USB 2.0 device

Digital I/O

The Digital I/O terminal block supports 4 digital input and 4 digital output

AT/ATX Switch

Used to select AT or ATX power mode

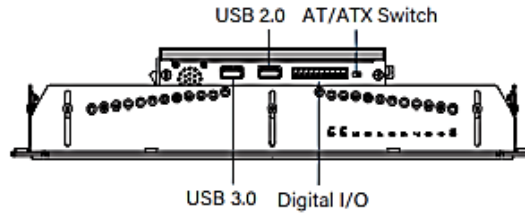

1.5.4 Right

COM2

COM2 supports RS232/422/485 serial device

DisplayPort

Used to connect a DisplayPort devices

Power LED

Indicates the power status of the system

HDD LED

Indicates the status of the hard drive

OSD Function:

LCD On/Off

Press to turn-on or turn-off the display



Increase Brightness

Press to increase brightness of the screen

Decrease Brightness

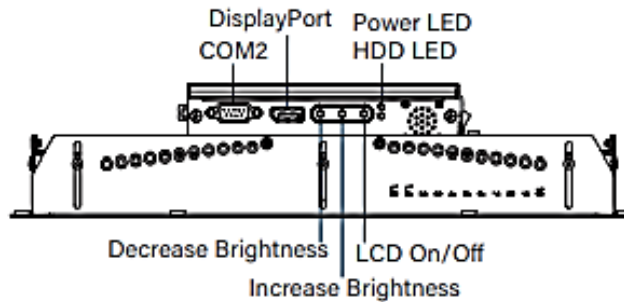
Press to decrease brightness of the screen





Chapter 2

Jumpers, Switches & Connectors

2.1 Jumpers Settings

When setting the jumpers, ensure that the jumper caps are placed on the correct pins. When the jumper cap is placed on both pins, the jumper is **short**. If you remove the jumper cap, or place the jumper cap on just one pin, the jumper is **open**. Refer to below for examples of the 2-pin and 3-pin jumpers when they are short (on) and open (off).

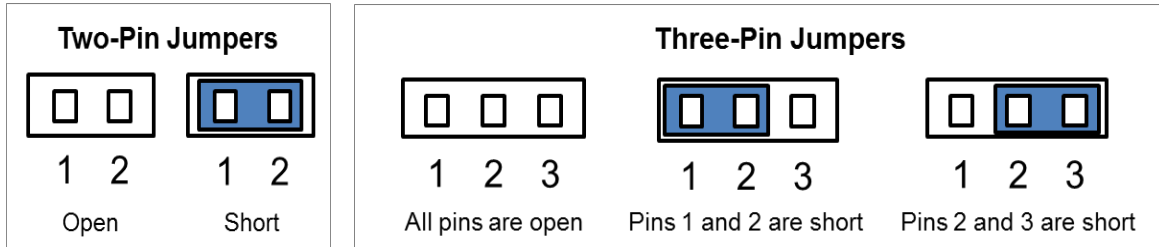

2.2 Location of the Jumpers/Switches/Connectors

2.2.1 Top View

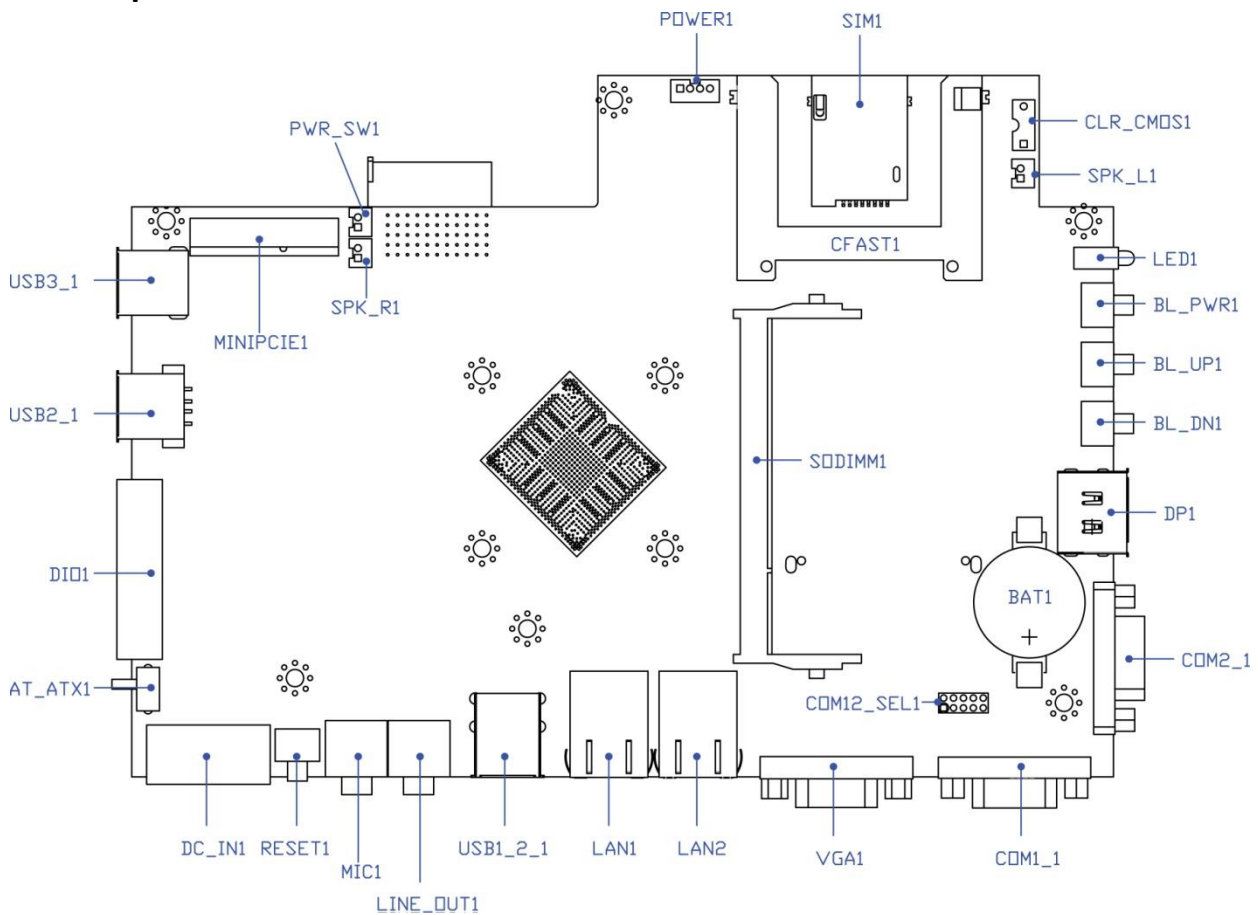

2.2.2 Bottom View

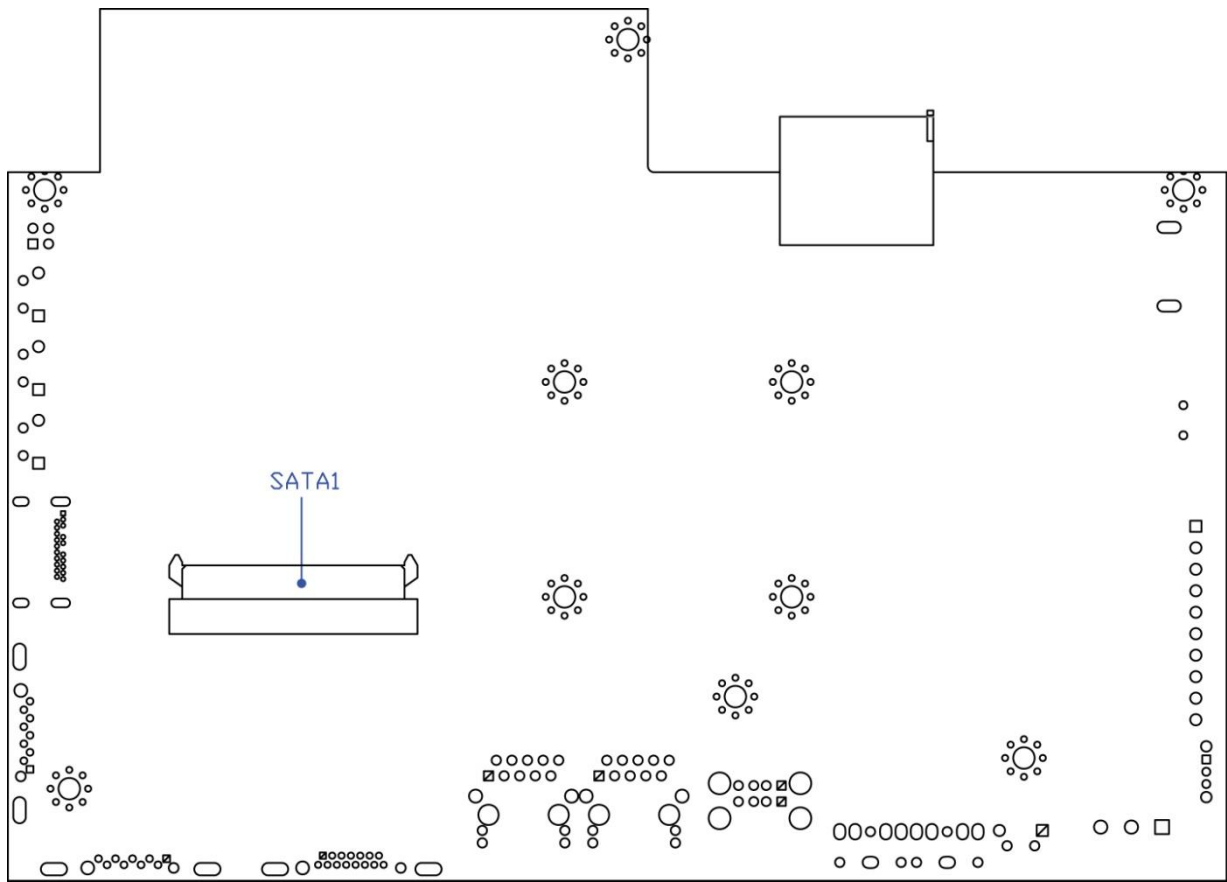

2.3 Definition of Jumpers/Switches/Connectors

List of Jumpers/Switches/Connectors

Location	Definition
AT_ATX1	AT / ATX Power Mode Switch
BL_PWR1	Backlight Power on / off switching
BL_UP1	Backlight Increase
BL_DN1	Backlight Decrease
CFAST1	CFAST Connector
CLR_CMOS1	Clear BIOS Switch
COM1_1, COM2_1	RS232 / RS422 / RS485 Connector
COM12_SEL1	COM1 / COM2 with Power Select
DC_IN1	3-pin DC 9-48V Power Input Connector
DIO1	4DI / 4DO Connector
DP1	DisplayPort Connector
LAN1, LAN2	LAN Port
LED1	Power / HDD Access LED Status
LINE_OUT1	Line-out Jack
MIC1	Mic-in Jack
MINIPCIE1	Mini PCI-Express Socket
POWER1	Power Connector
PWR_SW1	Power Switch Connector
RESET1	Reset Switch
SATA1	SATA with Power Connector
SIM1	SIM Card Socket
SPK_L1, SPK_R1	Internal Speaker Connector
USB1_2_1, USB2_1	USB 2.0 Port
USB3_1	USB 3.0 Port
VGA1	VGA Connector

2.4 Definition of Jumpers

COM12_SEL1: COM1 / COM2 with Power Select

Connector Type: 2X5 10-pin Header, 2.0mm pitch

COM1		COM2	
Pin	Definition	Pin	Definition
1-3 On	+5V	2-4 On	+5V
3-5 On	+12V	4-6 On	+12V
7-9 On (Default)	Reserved	8-10 On (Default)	Reserved

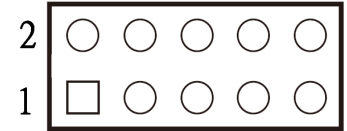

2.5 Definition of Switches

AT_ATX1: AT / ATX Power Mode Switch

Pin	Definition
1-2 (Left)	ATX Power Mode (Default)
2-3 (Right)	AT Power Mode

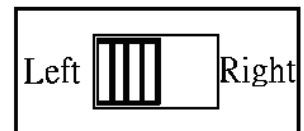

CLR_CMOS1: Clear CMOS Switch

Switch	Definition
1	Normal Status (Default)
ON	Clear CMOS



BL_PWR1: Backlight Power on / off

Switch	Definition
Push	Backlight Power on / off switching



BL_UP1: Backlight Increase

Switch	Definition
Push	Backlight Increase



BL_DN1: Backlight Decrease

Switch	Definition
Push	Backlight Decrease



RESET1: Reset Switch

Switch	Definition
Push	Reset System

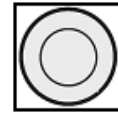

2.6 Definition of Connectors

CFAST1: CFast Connector

Pin	Definition	Pin	Definition	Pin	Definition
S1	GND	PC1	NC	PC10	NC
S2	SATA_TX2+	PC2	GND	PC11	NC
S3	SATA_TX2-	PC3	NC	PC12	NC
S4	GND	PC4	NC	PC13	+3.3V
S5	SATA_RX2-	PC5	NC	PC14	+3.3V
S6	SATA_RX2+	PC6	NC	PC15	GND
S7	GND	PC7	GND	PC16	GND
		PC8	NC	PC17	NC
		PC9	NC		

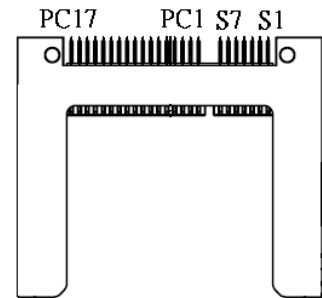

COM1~COM2: RS232 / RS422 / RS485 Connector

Connector Type: 9-pin D-Sub

Pin	RS232 Definition	RS422 / 485 Full Duplex Definition	RS485 Half Duplex Definition
1	DCD	TX-	DATA -
2	RXD	TX+	DATA +
3	TXD	RX+	
4	DTR	RX-	
5	GND		
6	DSR		
7	RTS		
8	CTS		
9	RI		

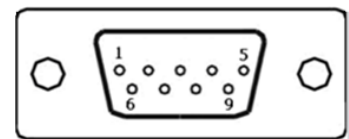

Pin	RS232	RS422/485	RS485
5	GND	GND	GND
9	0/5/12V	0/5/12V	0/5/12V

DC_IN1: DC Power Input Connector (+9-48V)

Connector Type: Terminal Block 1X3 3-pin, 5.0mm pitch

Pin	Definition
1	+9-48VIN
2	Chassis GND
3	GND

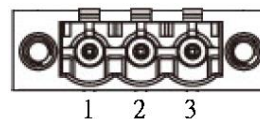

CAUTION

Please disconnect the power source before mounting the DC power cables or connecting the DC power connector to system.

DP1: DisplayPort Connector

Pin	Definition	Pin	Definition
1	DP_LANE0_P	11	GND
2	GND	12	DP_LANE3_N
3	DP_LANE0_N	13	GND
4	DP_LANE1_P	14	GND
5	GND	15	DP_AUX_P
6	DP_LANE1_N	16	GND
7	DP_LANE2_P	17	DP_AUX_N
8	GND	18	DP_HPD
9	DP_LANE2_N	19	GND
10	DP_LANE3_P	20	DP_PWR

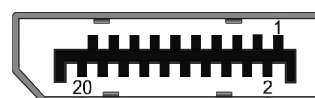

LAN1/LAN2: RJ45 with LEDs Port

Pin	Definition	Pin	Definition
1	LAN_MDI0P	5	LAN_MDI2N
2	LAN_MDI0N	6	LAN_MDI1N
3	LAN_MDI1P	7	LAN_MDI3P
4	LAN_MDI2P	8	LAN_MDI3N

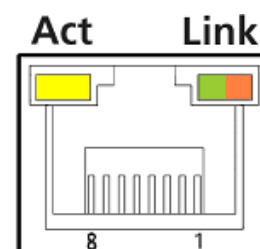

Act LED Status	Definition	Link LED Status	Definition
Blinking Yellow	Data Activity	Steady Green	1Gbps Network Link
Off	No Activity	Steady Orange	100Mbps Network Link
		Off	10Mbps Network Link

LED1: Power / HDD Access LED Status

Pin	Definition
1	HDD LED+
2	HDD LED-
3	POWER LED+
4	POWER LED-

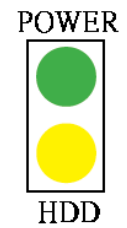

LED Status	LED Color
HDD	Yellow
POWER	Green

LINE_OUT1: Line-out Jack (Green)

Connector Type: 5-pin Phone Jack

Pin	Definition
1	GND
2	OUT_R
3	NC
4	GND
5	OUT_L



MIC1: Microphone Jack (Pink)

Connector Type: 5-pin Phone Jack

Pin	Definition
1	GND
2	MIC_R
3	NC
4	GND
5	MIC_L

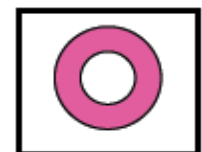

PWR_SW1 : Power Switch Connector

Pin	Definition
1	Power switch
2	GND



POWER1: Power Connector

Connector Type: 1X4-pin Wafer, 2.0mm pitch

Pin	Definition
1	+5V
2	GND
3	GND
4	+12V



SATA1: SATA with Power Connector

Pin	Definition	Pin	Definition
1	GND	12	GND
2	SATA_TX1+	13	GND
3	SATA_TX1-	14	+5V
4	GND	15	+5V
5	SATA_RX1-	16	+5V
6	SATA_RX1+	17	GND
7	GND	18	GND
8	+3.3V	19	GND
9	+3.3V	20	+12V
10	+3.3V	21	+12V
11	GND	22	+12V

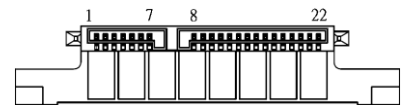

SIM1 : SIM Card Socket

Pin	Definition
C1	UIM_PWR
C2	UIM_RESET
C3	UIM_CLK
C5	GND
C6	UIM_VPP
C7	UIM_DATA
CD	NC
COM	GND

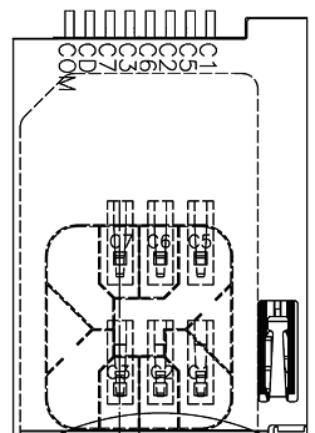

SPK_L1: Left Internal Speaker Connector

Pin	Definition
1	OUT_L
2	GND

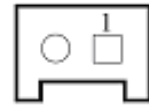

SPK_R1: Right Internal Speaker Connector

Pin	Definition
1	OUT_R
2	GND



USB1_2_1 : USB2.0 Connector, Type A

Pin	Definition	Pin	Definition
1	+5V	5	+5V
2	USB_DATA0-	6	USB_DATA_1-
3	USB_DATA0+	7	USB_DATA_1+
4	GND	8	GND

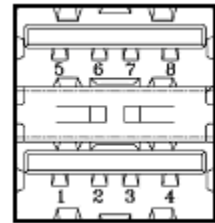

USB2_1: USB2.0 Connector, Type A

Pin	Definition
1	+5V
2	USB2_DATA1-
3	USB2_DATA1+
4	GND



USB3_1: USB 3.0 Connector, Type A

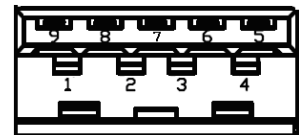

Pin	Definition	Pin	Definition
1	+5V	6	USB3_RX0+
2	USB2_D0-	7	GND
3	USB2_D0+	8	USB3_TX0-
4	GND	9	USB3_TX0+
5	USB3_RX0-		

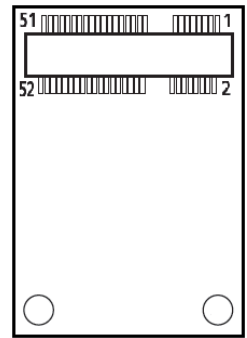

MINIPCIE1: Mini PCI-Express Socket

Pin	Definition	Pin	Definition	Pin	Definition
1	WAKE#	19	NC	37	GND
2	+3.3V	20	+3.3V	38	USB2_3P
3	NC	21	GND	39	+3.3V
4	GND	22	MINIPCIE_RST#	40	GND
5	NC	23	MINIPCIE_RXN	41	+3.3V
6	+1.5V	24	+3.3V	42	NC
7	CLKREQ#	25	MINIPCIE_RXP	43	GND
8	UIM_PWR	26	GND	44	NC
9	GND	27	GND	45	NC
10	UIM_DATA	28	+1.5V	46	NC
11	MINIPCIE_CLKN	29	GND	47	NC
12	UIM_CLK	30	SMB_CLK	48	+1.5V
13	MINIPCIE_CLKP	31	MINIPCIE_TXN	49	NC
14	UIM_RESET	32	SMB_DATA	50	GND
15	GND	33	MINIPCIE_TXP	51	NC
16	UIM_VPP	34	GND	52	+3.3V
17	NC	35	GND		
18	GND	36	USB2_3N		





Chapter 3

System Setup

This chapter takes P1001 as an example to demonstrate the installation of hardware components.

3.1 Removing Top Cover



WARNING

In order to prevent electric shock or system damage, before removing the chassis cover, must turn off power and disconnect the unit from power source.

1. Loosen the 8 screws of front and rear panel, then place them aside.



2. Remove the cover from the chassis.



3. Place the top cover gently.



3.2 Installing Half Size Mini PCIe Card

1. Locate the Mini PCIe slot.

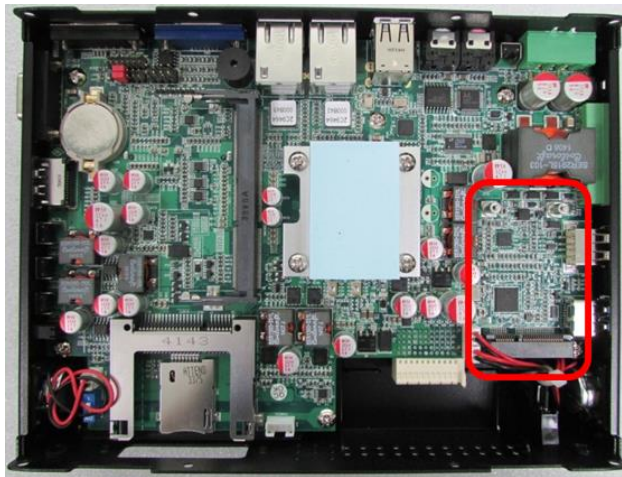

2. Use provided two screws on bracket to fasten the module and bracket together.

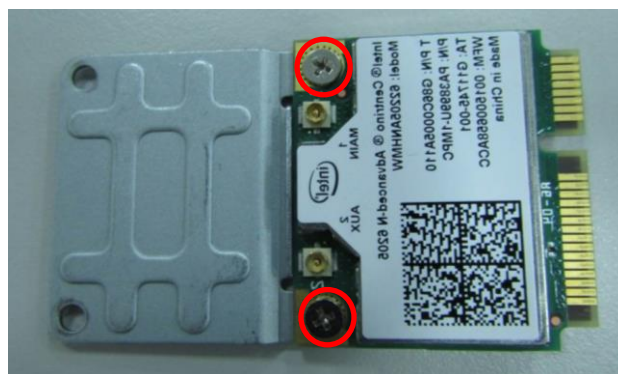

3. Tilt the Mini PCIe module at 45-degree angle and insert it to the slot until the gold-pated connector of module contacted firmly with the slot.

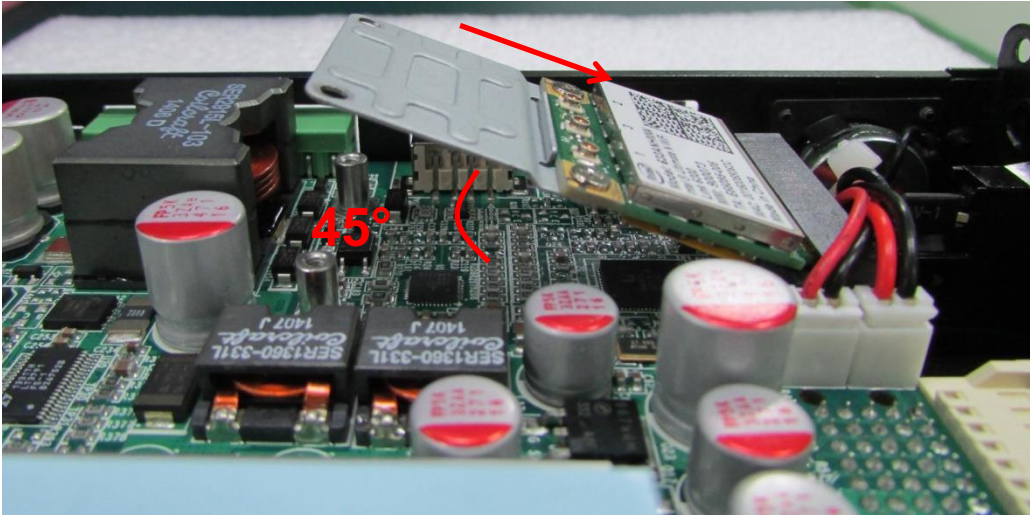

4. Press down the module and use the two screws to fix the module.

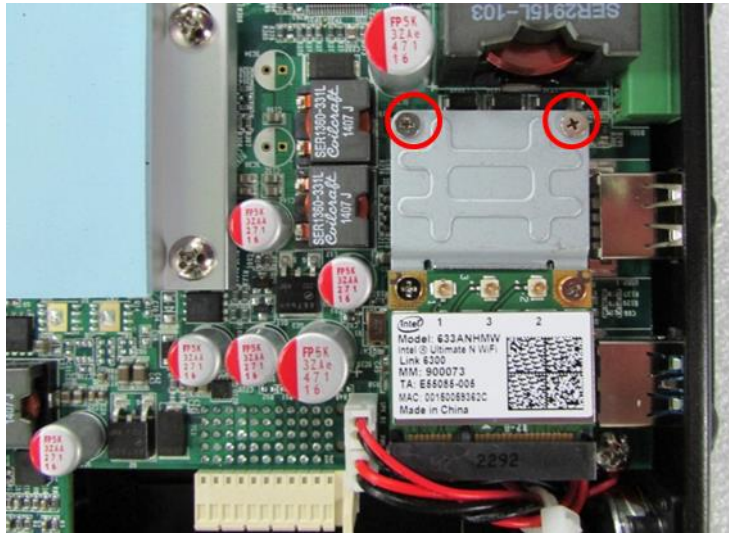

3.3 Installing Full Size Mini PCIe Card

1. Locate the Mini PCIe slot.

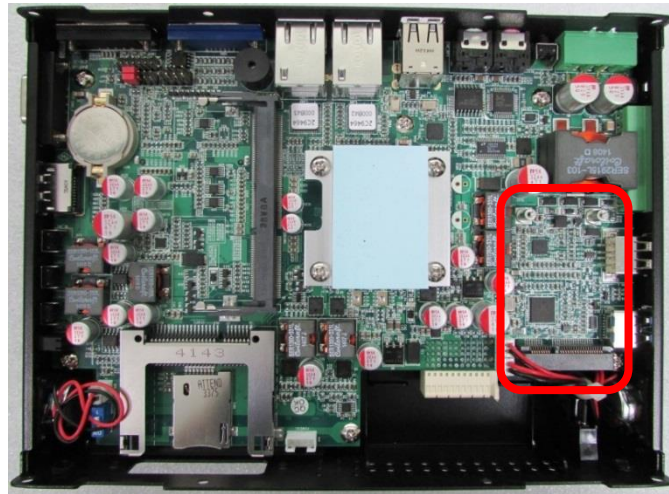

2. Tilt the Mini PCIe module at 45-degree angle and insert it to the slot until the gold-pated connector of module contacted firmly with the slot.

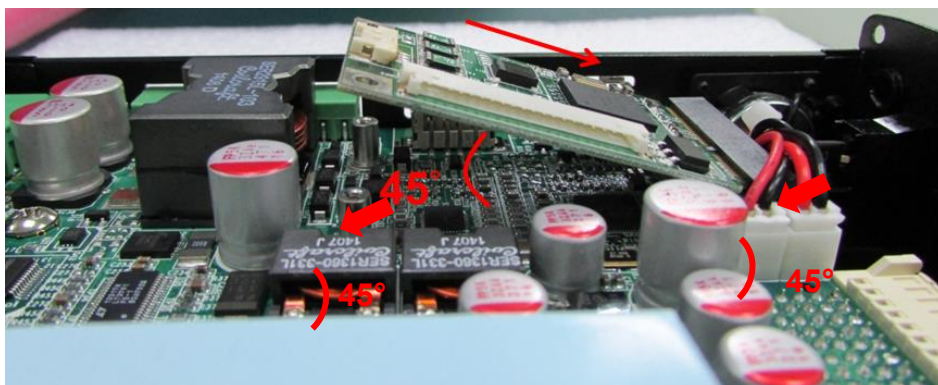

3. Press down the module and use the two screws to fix the module.



3.4 Installing Antenna(s)

1. Remove the antenna hole covers at front panel.



2. Have antenna jack penetrate through the hole.

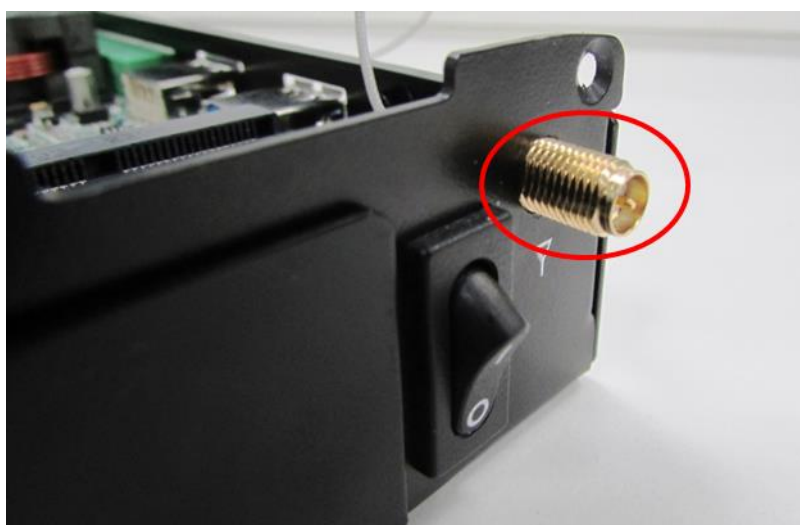

- Put on washer and fasten the nut with antenna jack.



- Assemble the antenna and antenna jack together.



- Attach the RF connector at another end of cable onto the module.

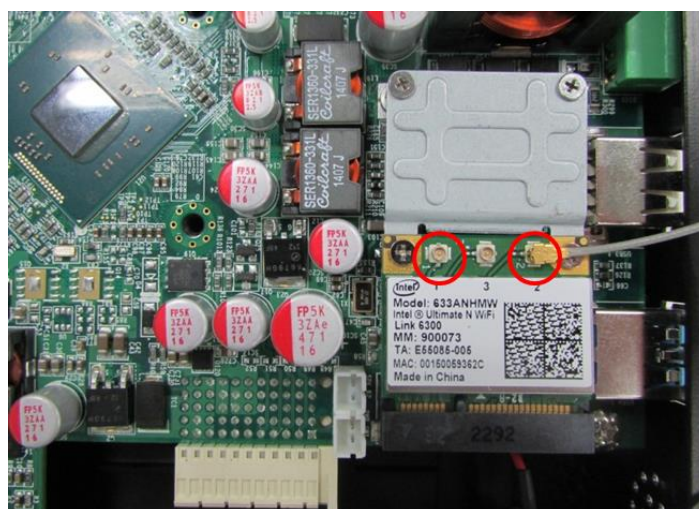

3.5 Installing SO-DIMM Memory

1. Locate SO-DIMM socket.

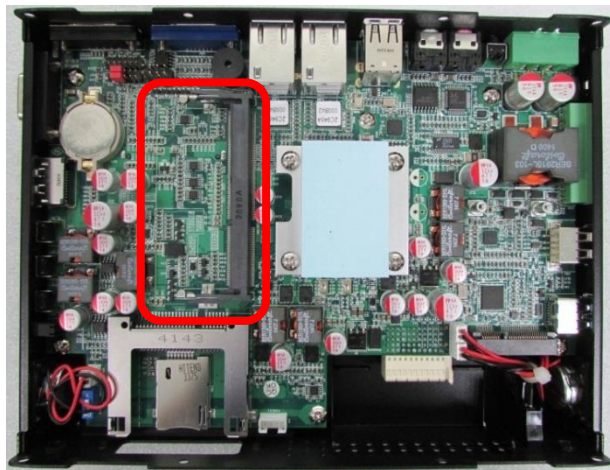

2. Tilt the SODIMM module at a 45-degree angle and insert it to SODIMM socket until the gold-pated connector of module contacted firmly with the socket.

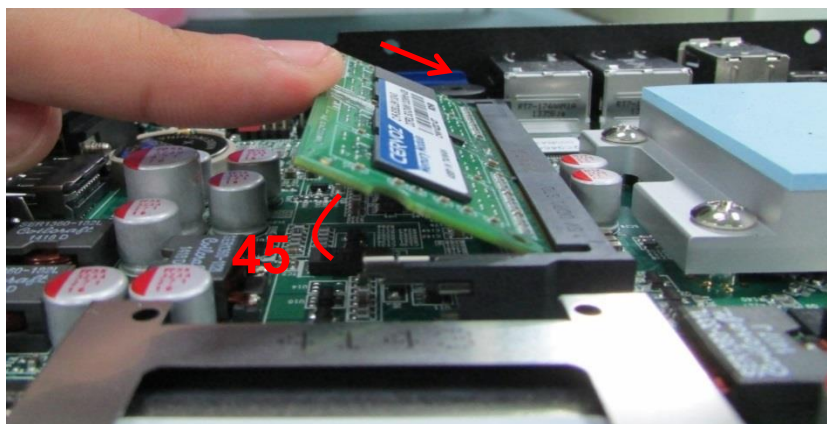

3. Press the module down until its fixed firmly by the two locking latches on each side.



3.6 Installing Top Cover

1. Put on the cover.



2. Fasten the 8 screws to fix the cover.



3.7 Installing SATA Hard Drive

1. Locate the removable HDD bay and loosen the 3 screws.



2. Pull out the HDD bracket.



3. Make the PCB side of the HDD face up, place the HDD bracket on it. Ensure the direction of bracket is correct and use 4 provided screws to assemble HDD and HDD bracket together.



4. Align the HDD bracket with the entrance of HDD bay. And insert the HDD bracket until the connector of HDD contact the SATA connector firmly.



3.8 Installing SIM Card

1. SIM card slot is at the front panel of the system.



2. Remove the mounting cover by unscrewing the two screws.

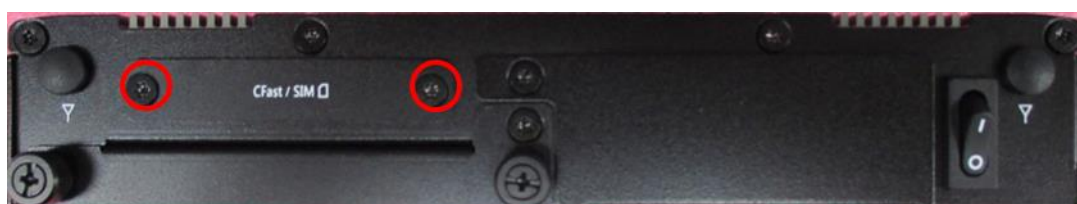

3. Insert the SIM card.



3.9 Installing CFast Card

1. Locate the CFast card slot.



2. Remove the mounting cover by unscrewing the two screws.

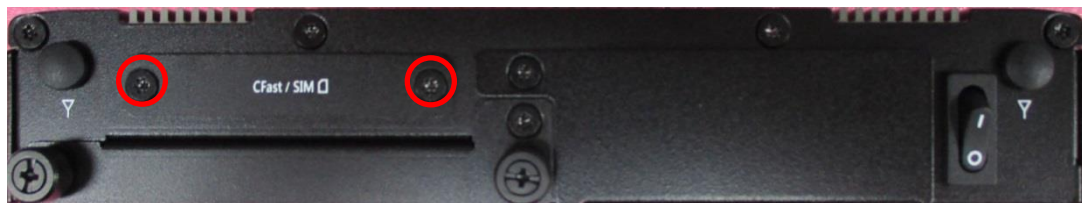

3. Insert the CFast card until it clicks.



3.10 Disassemble the CO Display Module

The complete shipping product is the CO display module already installed on the P1001. This chapter will introduce how to disassemble CO display module and P1001.

1. Remove the 6 screws on the display module.

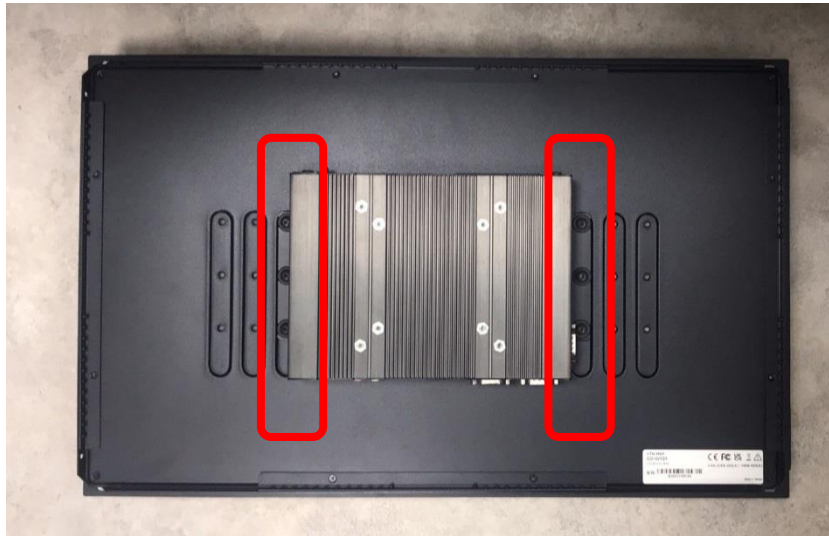

2. Disconnect the modules.

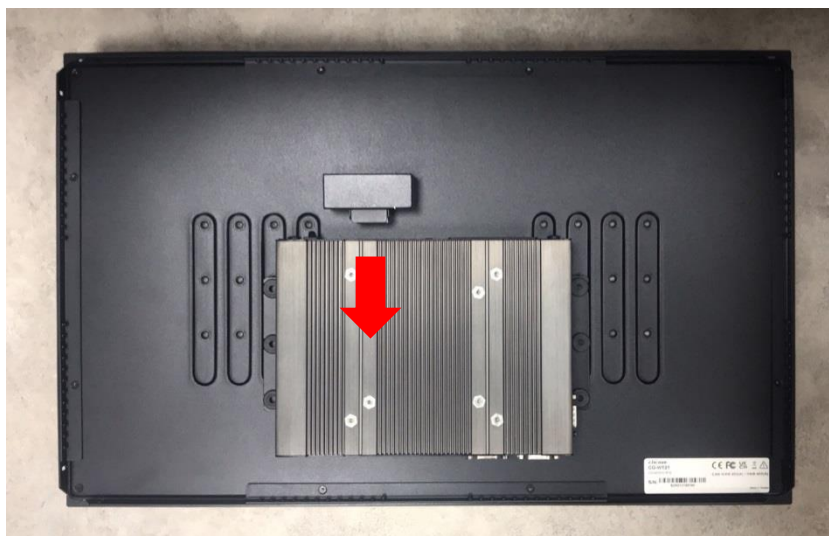

3.11 Installing Standard Mount

The CO-100 series currently features two types of Mounting Bracket designs. For example, the Mounting Bracket designs of CO-W121C and CO-119C as illustrated below.



CO-W121C



CO-119C

CO-119C is essentially identical to CO-W121C in terms of installation, with the only difference being the design of the Mounting Bracket. The following steps will demonstrate the installation using CO-W121C as an example.

Before doing the following steps, please make sure the screw positions are fastened at the default positions as indicated in the following picture. The default positions are the correct positions for Standard Mount, so it does not need to change the screw positions additionally for Standard Mount.



1. Put the CO-100/P1001 module onto the rack's back side.

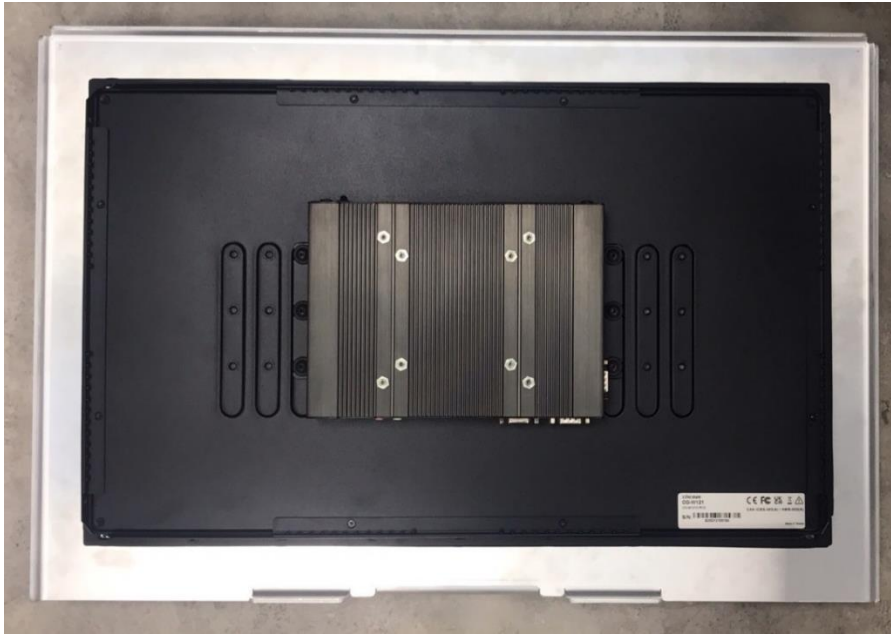

There are two methods for fastening the CO-100/P1001 module onto the cabinet to complete the standard mount. One is to fix the CO-100/P1001 module from the front side of the cabinet, which is illustrated in chapter 3.11.1. The other one is to fix the CO-100/P1001 module from the rear side of the cabinet, which is illustrated in chapter 3.11.2.

3.11.1 Fixing from front side

1. Fasten the screws from the cabinet's front side. Please prepare 12 pcs of M4 screws for fixing the module through the **circle holes** (with screw thread).

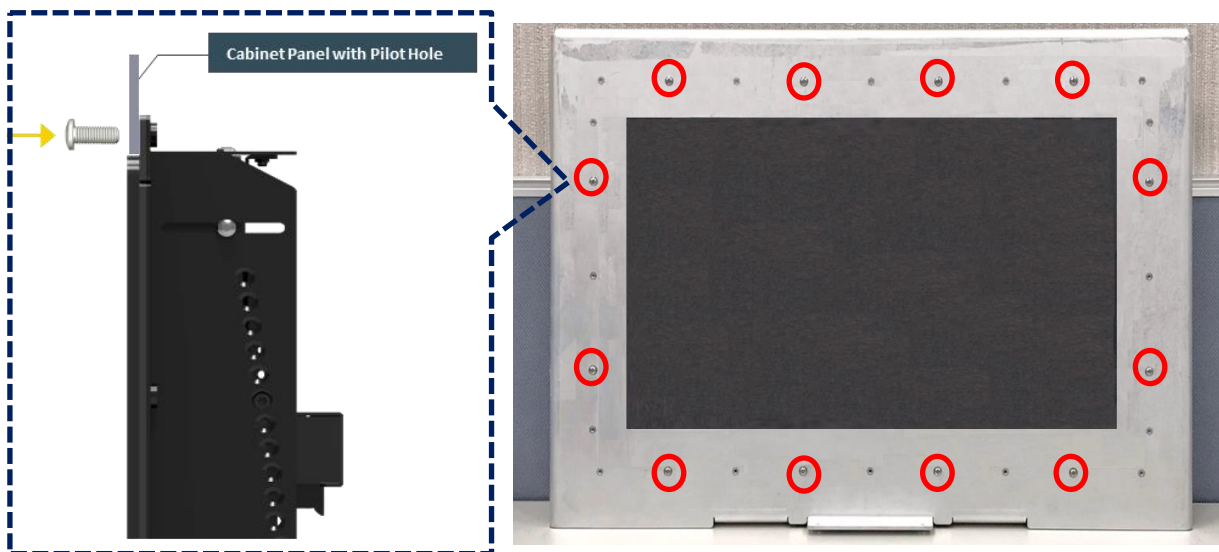

3.11.2 Fixing from rear side

1. If the cabinet panel is with stud bolts as the following figure, user can prepare 16 pcs of nuts for fixing the module through the **oblong holes** (oblong hole size: 9mmx4mm, without screw thread).

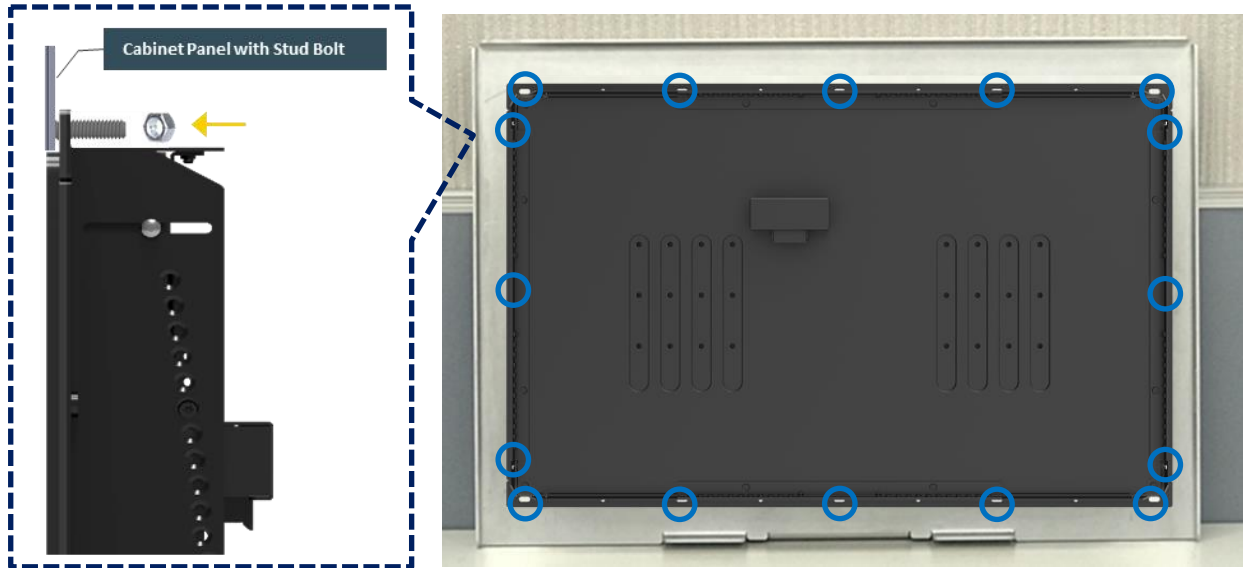

If the cabinet panel is with bosses as the following figures, user can prepare 16 pcs of M4 screws for fixing the module through the **oblong holes** (oblong hole size: 9mmx 4mm, without screw thread).

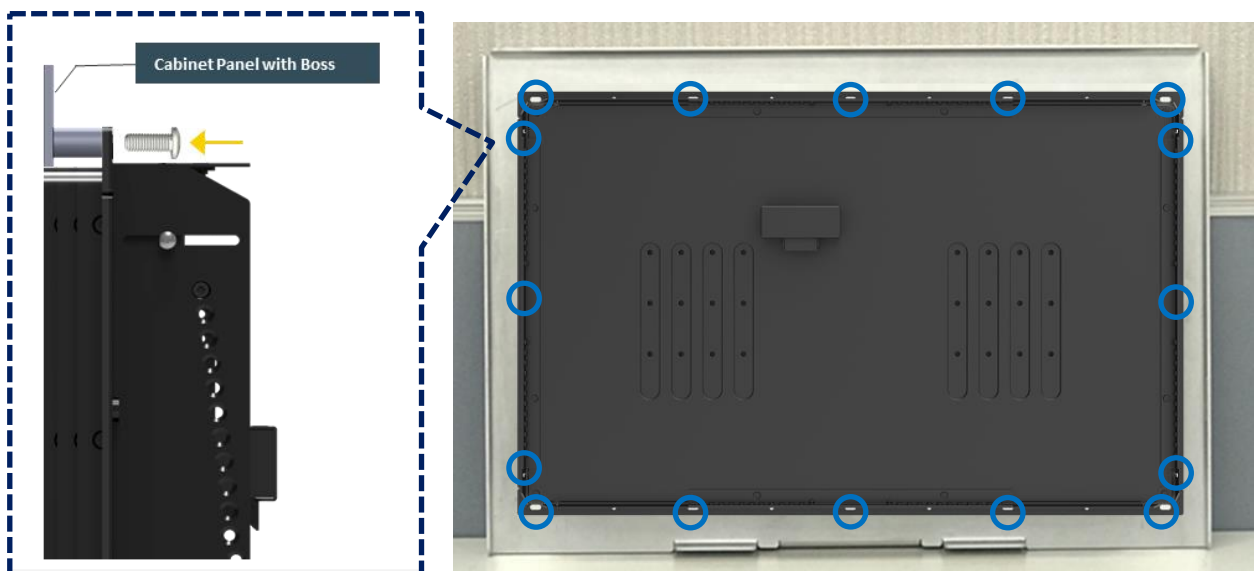

3.12 Installing Flat Mount

The CO-100 series currently features two types of Mounting Bracket designs. For example, the Mounting Bracket designs of CO-W121C and CO-119C as illustrated below.



CO-W121C



CO-119C

CO-119C is essentially identical to CO-W121C in terms of installation, with the only difference being the design of the Mounting Bracket. The following steps will demonstrate the installation using CO-W121C as an example.

1. Locate the left and right-side mounting brackets.

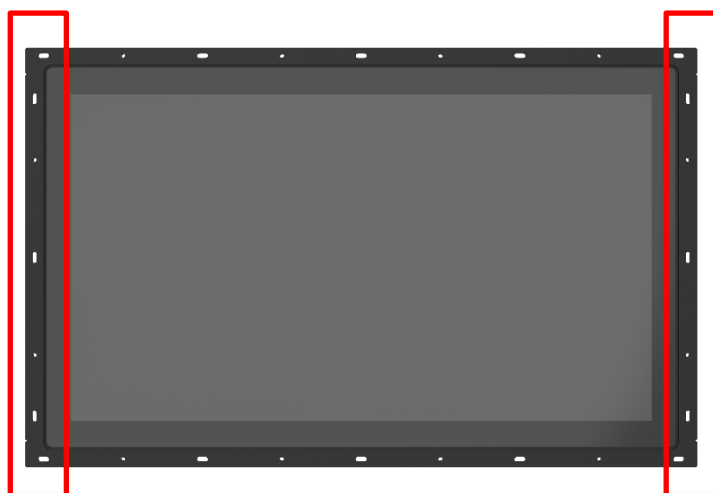

2. Remove the two screws on the left and right-side mounting brackets.



3. Loosen the three screws on the left and right-side mounting brackets.



4. Measure the rack thickness. The thickness is measured 3mm in this example.

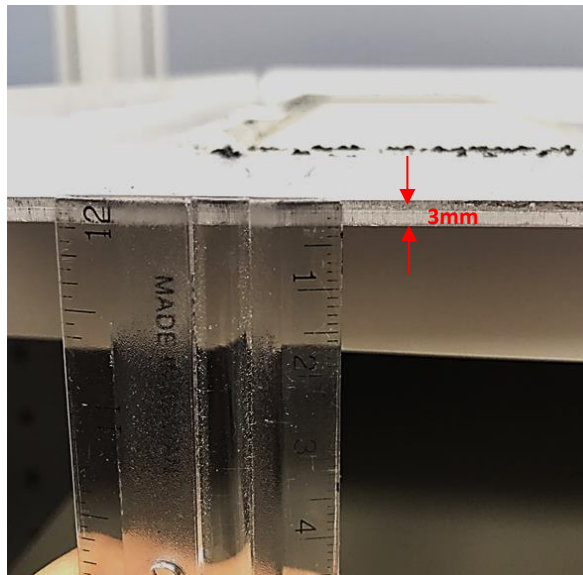

5. According to the thickness = 3mm for the example, push down the left and right-side mounting brackets to the place at screw hole = 3mm.



6. Fasten the two screws on the left and right-side mounting brackets.



7. Fasten the three screws on the left and right-side mounting brackets.



8. Locate the top and bottom-side mounting brackets.

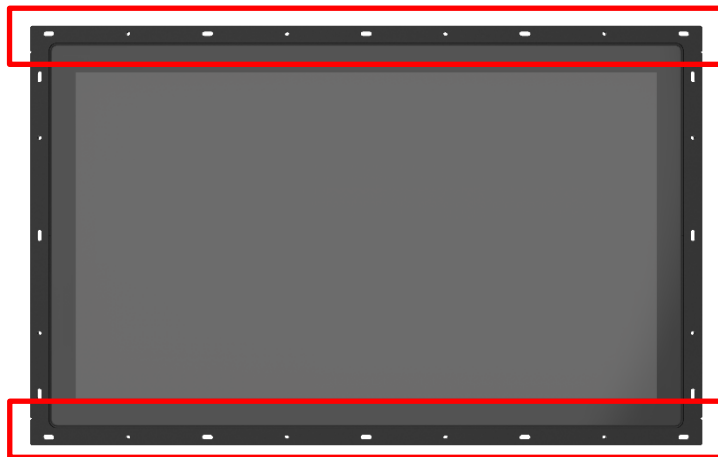

9. Remove the two screws on the top and bottom-side mounting brackets.

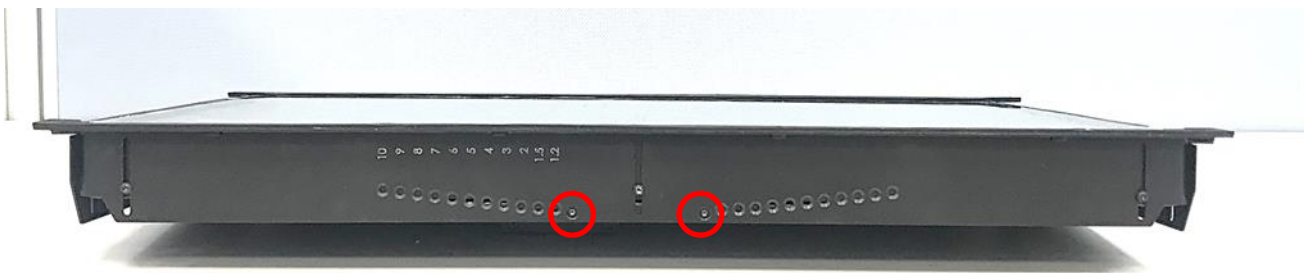

10. Loosen the three screws on the top and bottom-side mounting brackets.



11. According to the thickness = 3mm for the example, push down the top and bottom-side mounting brackets to the place at screw hole = 3mm.

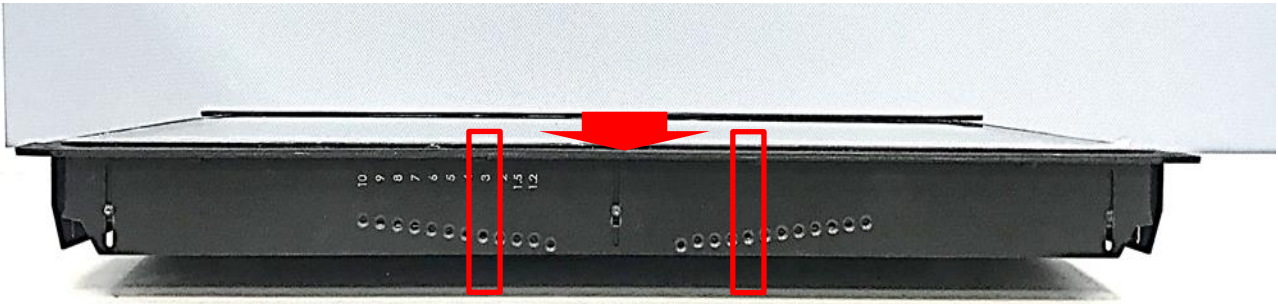

12. Fasten the two screws on the top and bottom-side mounting brackets.



13. Fasten the three screws on the top and bottom-side mounting brackets.



14. Put the CO-100/P1001 module onto the rack back side.

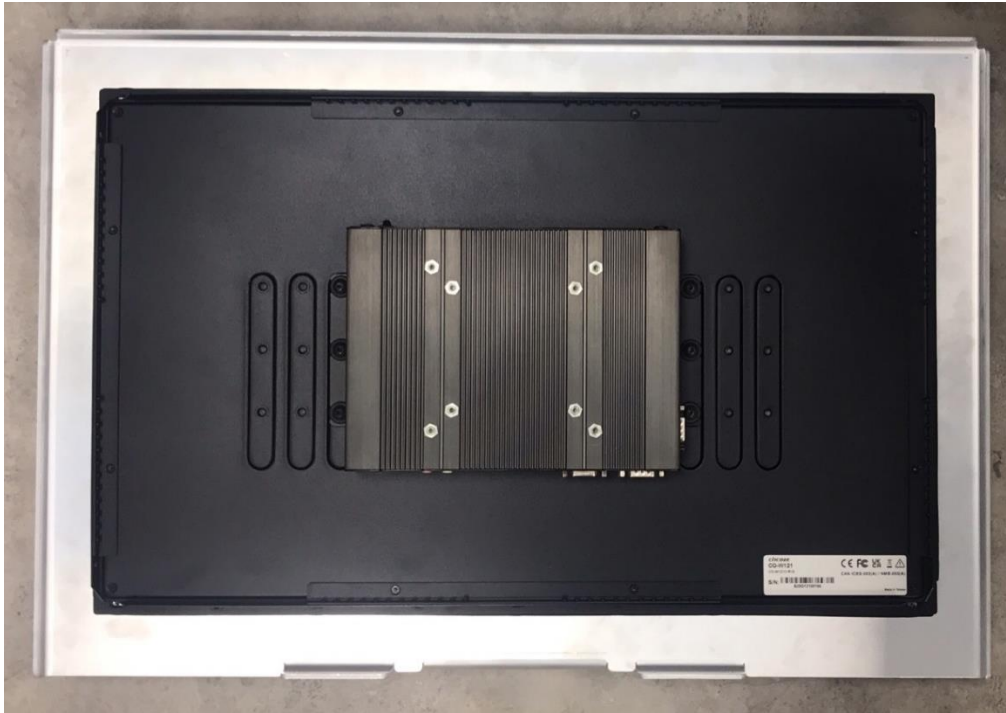

There are two methods for fastening the CO-100/P1001 module onto the cabinet to complete the flat mount. One is to fix the CO-100/P1001 module from the front side of the cabinet, which is illustrated in chapter 3.12.1. The other one is to fix the CO-100/P1001 module from the rear side of the cabinet, which is illustrated in chapter 3.12.2.

3.12.1 Fixing from front side

1. Fasten the screws from the cabinet's front side. Please prepare 12 pcs of M4 screws for fixing the module through the **circle holes** (with screw thread).

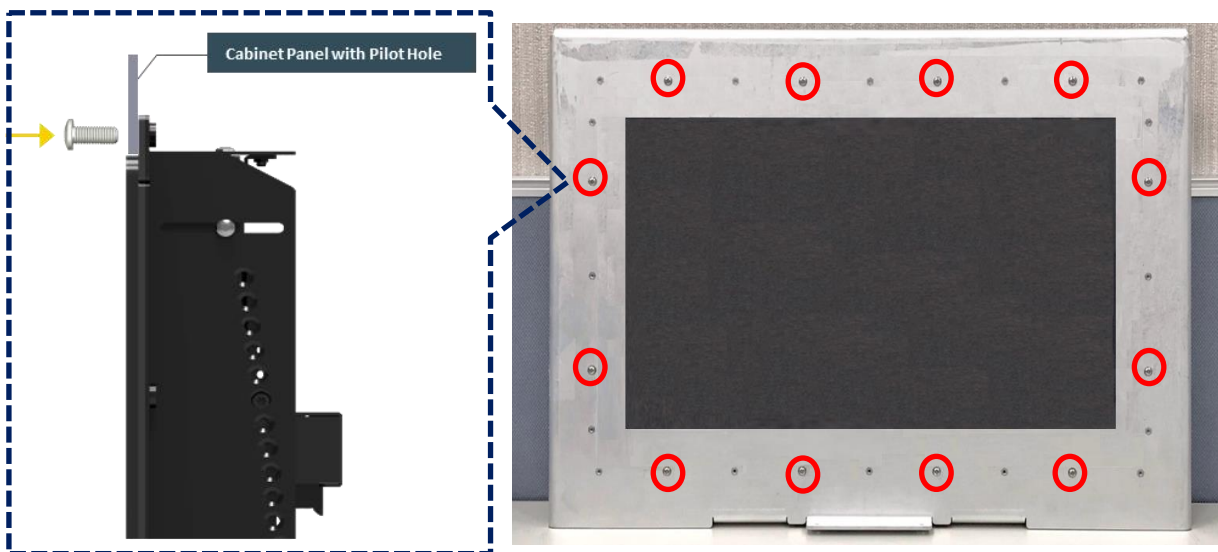

3.12.2 Fixing from rear side

1. If the cabinet panel is with stud bolts as the following figure, user can prepare 16 pcs of nuts for fixing the module through the **oblong holes** (oblong hole size: 9mmx4mm, without screw thread).

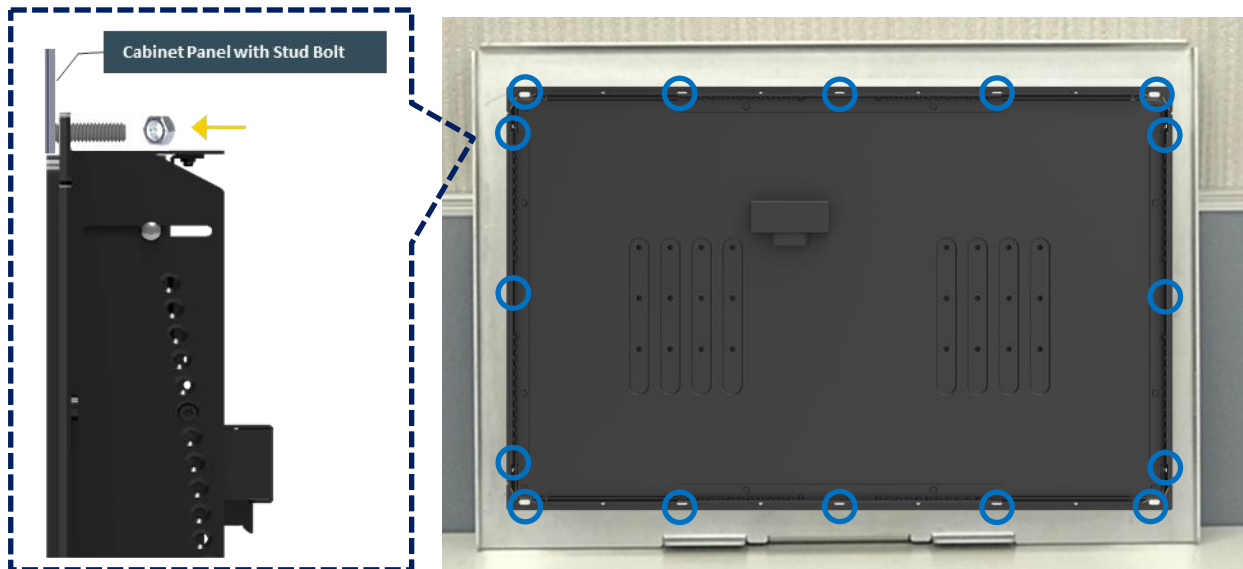

If the cabinet panel is with bosses as the following figures, user can prepare 16 pcs of M4 screws for fixing the module through the **oblong holes** (oblong hole size: 9mmx 4mm, without screw thread).

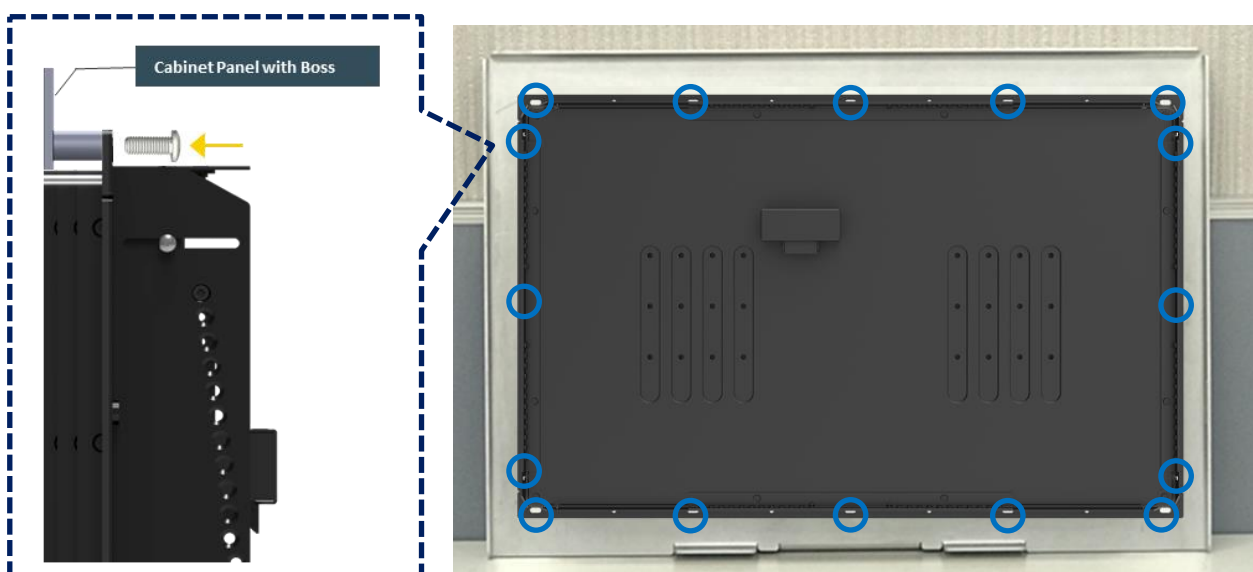

3.13 Disassemble the mounting brackets

The CO-100 series currently features two types of Mounting Bracket designs. For example, the Mounting Bracket designs of CO-W121C and CO-119C as illustrated below.



CO-W121C



CO-119C

CO-119C is essentially identical to CO-W121C in terms of installation, with the only difference being the design of the Mounting Bracket. The following steps will demonstrate the installation using CO-W121C as an example.

Before the installation of VESA mount and rack mount, user need to disassemble the mounting brackets on the CO display module first.

1. Remove the 8 screws.

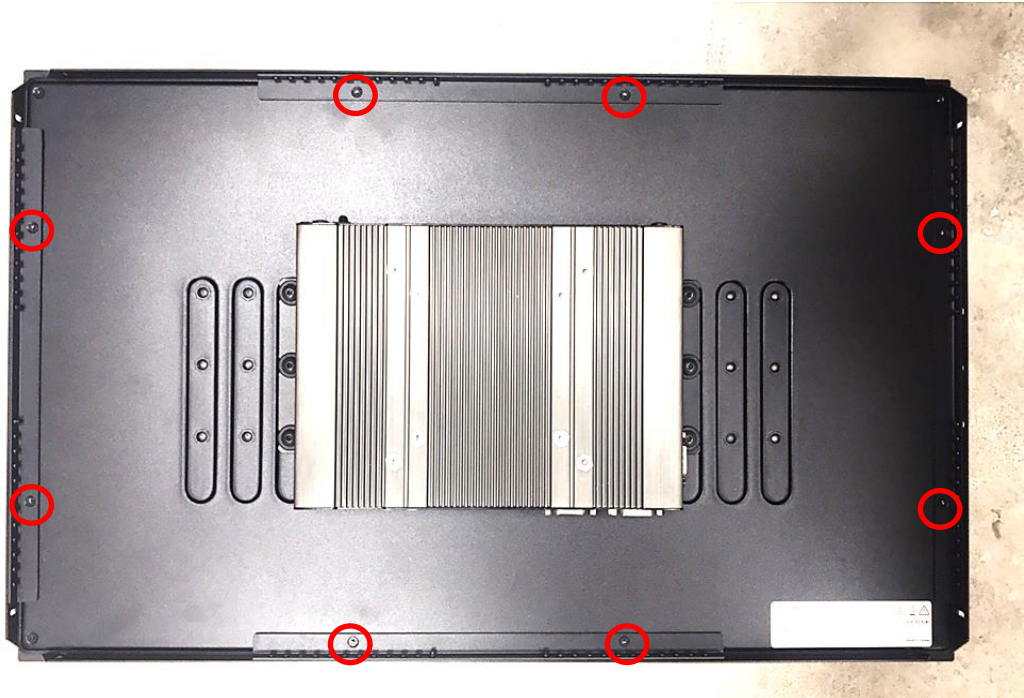

2. Remove the 3 screws on the left and right side of mounting brackets.





3. Remove the 3 screws on the top and bottom side of mounting brackets.



4. Remove the four mounting brackets.





Chapter 4

BIOS Setup

4.1 BIOS Introduction

The BIOS (Basic Input/ Output System) is a program located on a Flash Memory on the motherboard. When you start the computer, the BIOS program will gain control. The BIOS first operates an auto-diagnostic test called POST (power on self-test) for all the necessary hardware, it detects the entire hardware device and configures the parameters of the hardware synchronization.

BIOS Setup

Power on the computer and by pressing immediately allows you to enter Setup. If the message disappears before your respond and you still wish to enter Setup, restart the system to try again by turning it OFF then ON or pressing <Ctrl>, <Alt> and <Delete> keys.

Control Keys	
<←> <→>	Move to select screen
<↑> <↓>	Move to select item
<Esc>	Quit the BIOS Setup
<Enter>	Select item
<Page Up/+>	Increases the numeric value or makes changes
<Page Down/->	Decreases the numeric value or makes changes
<Tab>	Select setup fields
<F1>	General help
<F2>	Previous value
<F3>	Load Optimized defaults
<F10>	Save configuration and Exit

Main Menu

The main menu lists the setup functions you can make changes to. You can use the arrow keys (↑↓) to select the item. The on-line description of the highlighted setup function is displayed at the bottom of the screen.

Sub-Menu

If you find a right pointer symbol appears to the left of certain fields that means a sub-menu can be launched from this field. A sub-menu contains additional options for a field parameter. You can use arrow keys (↑↓) to highlight the field and press <Enter> to call up the sub-menu. Then you can use the control keys to enter values and move from field to field within a sub-menu. If you want to return to the main menu, just press the <Esc >.

4.2 Main Setup

Press to enter BIOS CMOS Setup Utility, the Main Menu (as shown below) will appear on the screen. Use arrow keys to move among the items and press <Enter> to accept or enter a sub-menu.

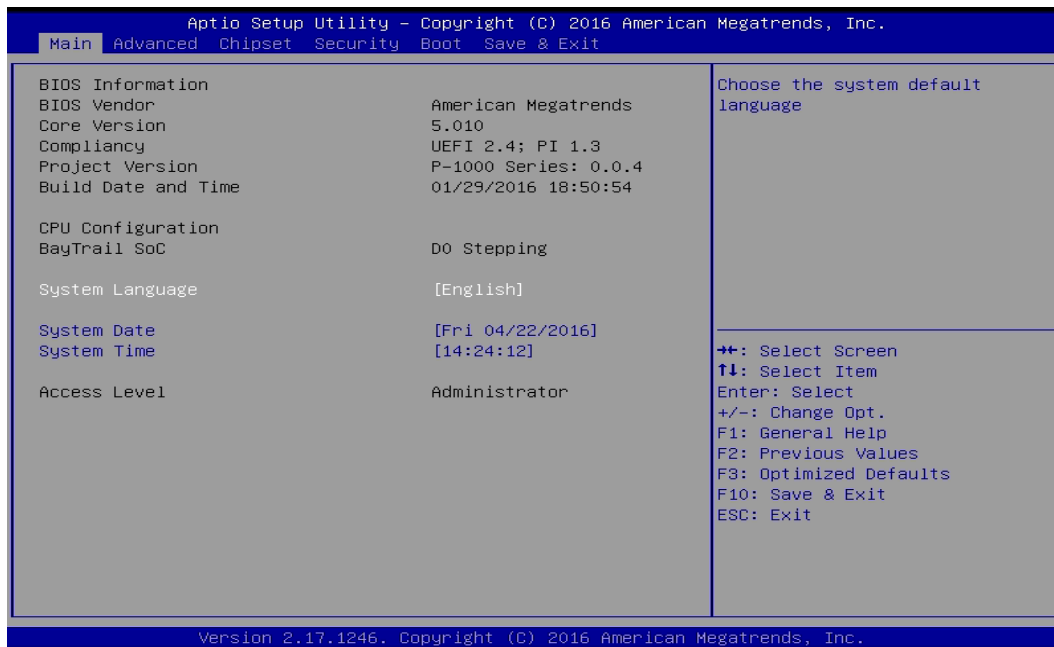

4.2.1 System Date

Set the date. Please use <Tab> to switch between date elements.

4.2.2 System Time

Set the time. Please use <Tab> to switch between time elements.

4.3 Advanced Setup

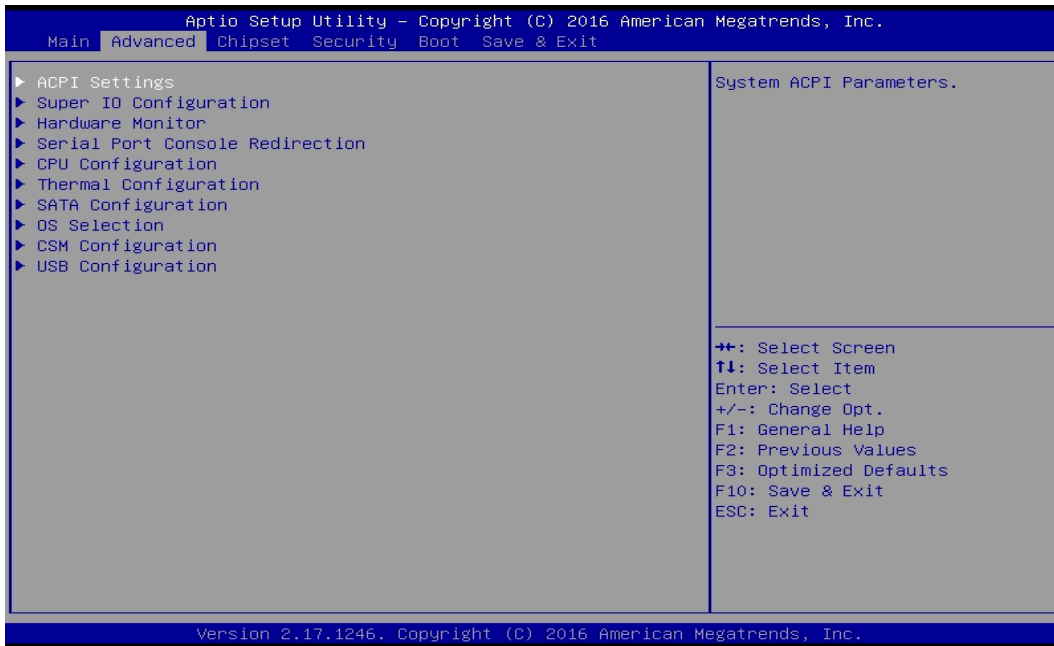

4.3.1 ACPI Settings

Enable or disable ACPI Auto Configuration.

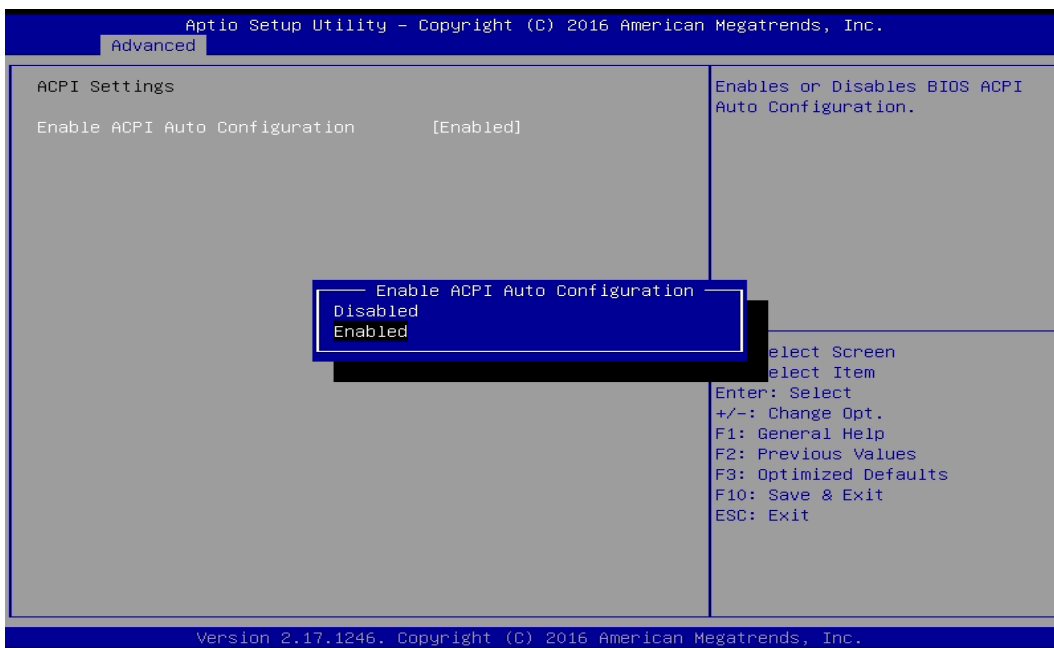

4.3.2 Super IO Configuration

You can use this screen to select options for the Super IO Configuration, and change the value of the selected option.



Serial Port 1 Configuration

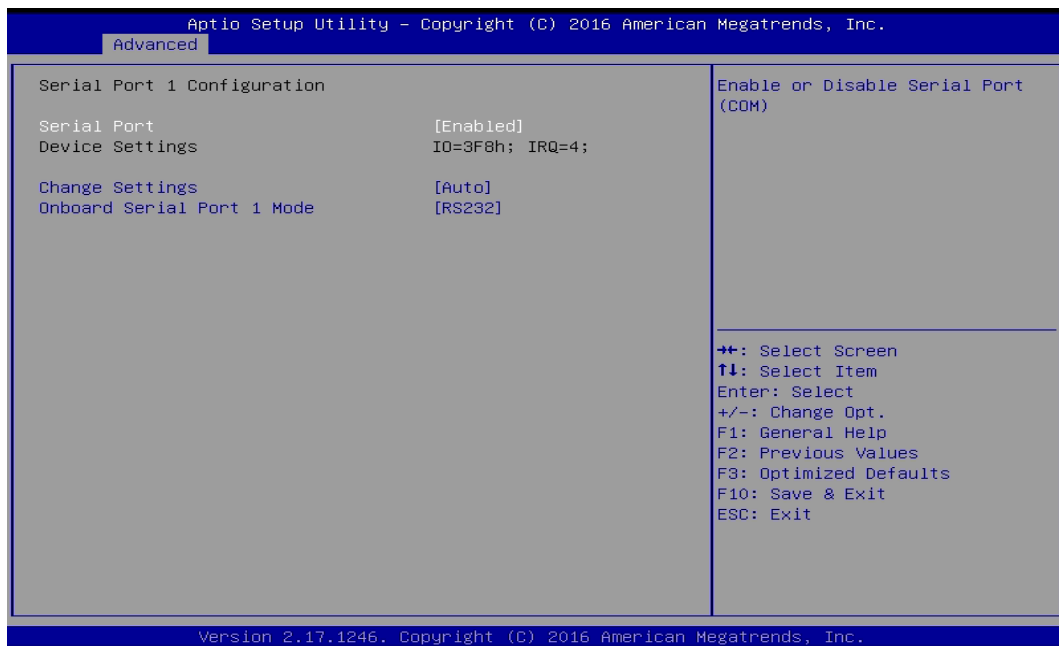

Serial Port

This item will allow users to enable or disable serial port.

Change Settings

Used to change the address & IRQ settings of the specified serial port.

Onboard Serial Port 1 Mode

Change the Serial interface. Select <RS232>, <RS422> or <RS485> interface.

■ Watch Dog Function

You can setup the system watch-dog timer, a hardware timer that generates a reset when the software that it monitors does not respond as expected each time the watch dog polls it.

Watch Dog Mode

Change the Watch dog mode. Select <Sec> or <Min> mode.

Watch Dog Timer

User can set a value in the range of 0 to 255.

4.3.3 Hardware Monitor

These items display the current status of all monitored hardware devices/components such as voltages and temperatures.

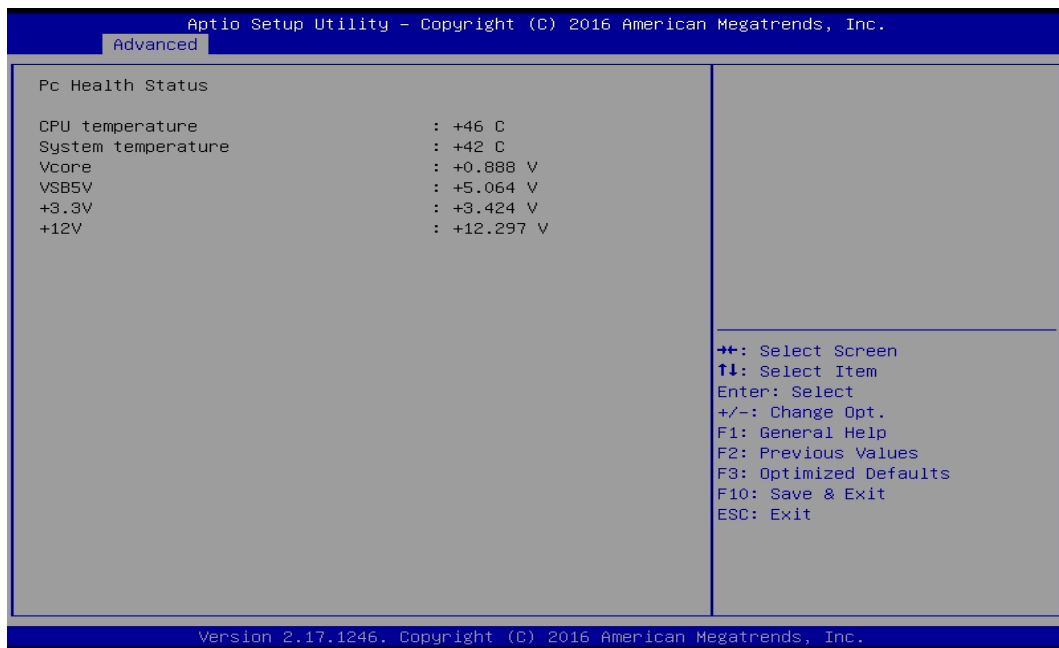

4.3.4 Serial Port Console Redirection

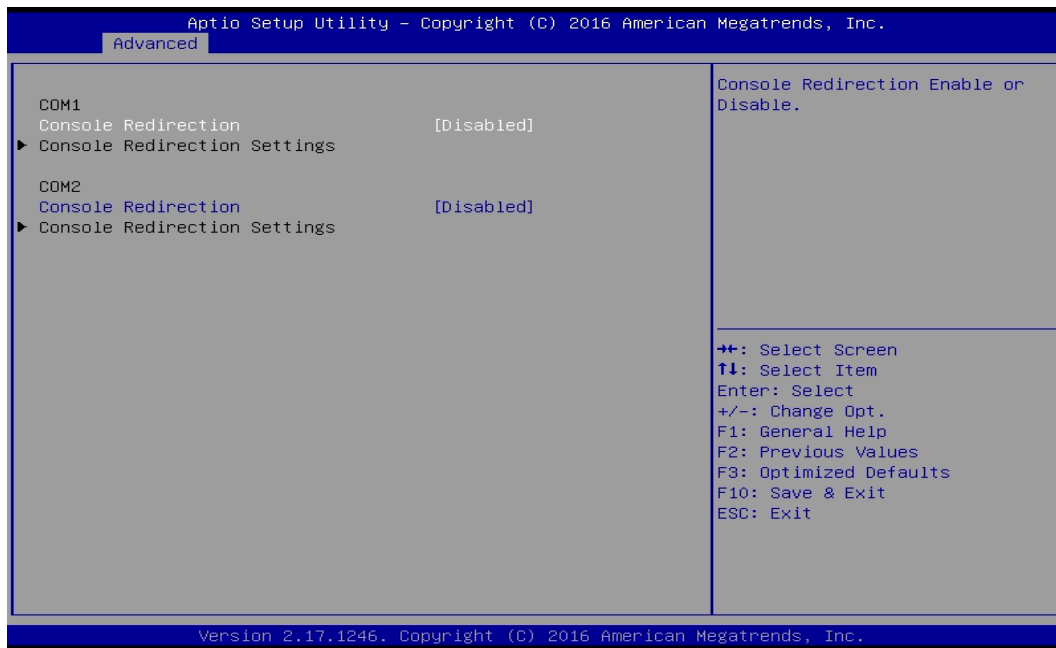

■ Console Redirection

This item allows users to enable or disable console redirection.

4.3.5 CPU Configuration

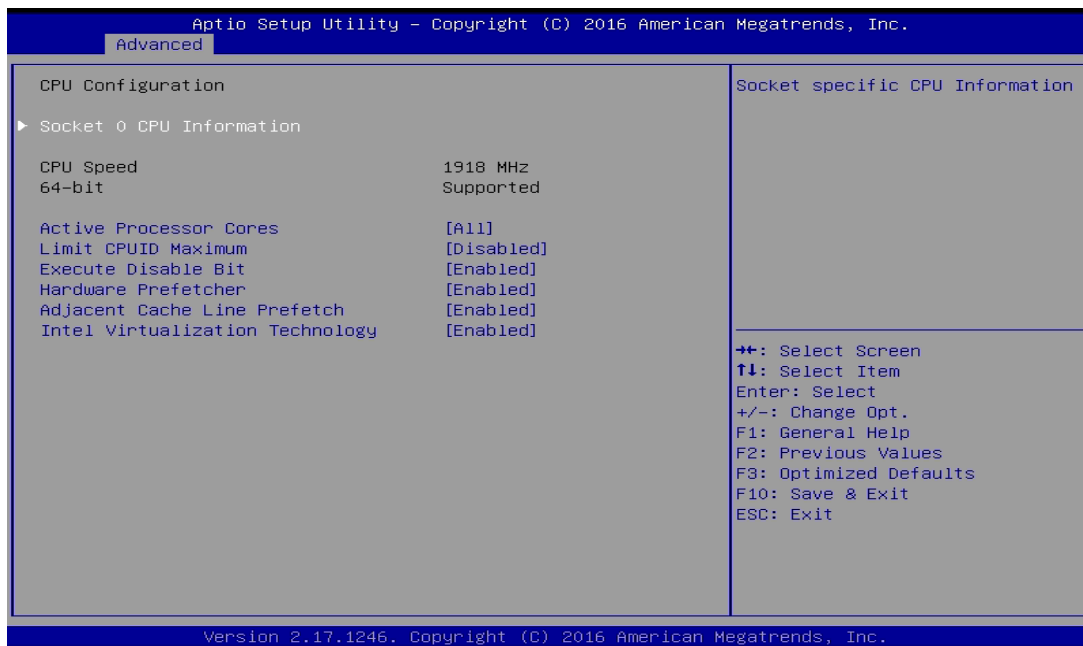

■ Socket 0 CPU Information

This section provides information on your CPU, frequency, and cache memory.

■ Active Processor Cores

Change the active processor cores. Select <All> or <1> mode.

■ Limit CPUID Maximum

This option is only useful if you are using an operating system that does not recognize all of the features of your processor.

Allows user to determine whether to limit CPUID maximum value. Set this item to

Disabled: For Windows XP operating system.

Enabled: For legacy operating system such as Windows NT4.0. (Default: Disabled)

■ Execute Disable Bit

Enables or disables Intel Execute Disable Bit function.

■ Hardware Prefetcher

Enables or disables L2 Cache Hardware Prefetcher.

■ Adjacent Cache Line Prefetch

Enables or disables L2 prefetching of adjacent cache lines.

■ Intel Virtualization Technology

Enables or disables Intel Virtualization Technology. Virtualization enhanced by Intel Virtualization Technology will allow a platform to run multiple operating systems and applications in independent partitions. With virtualization, one computer system can function as multiple virtual systems.

4.3.6 Thermal Configuration

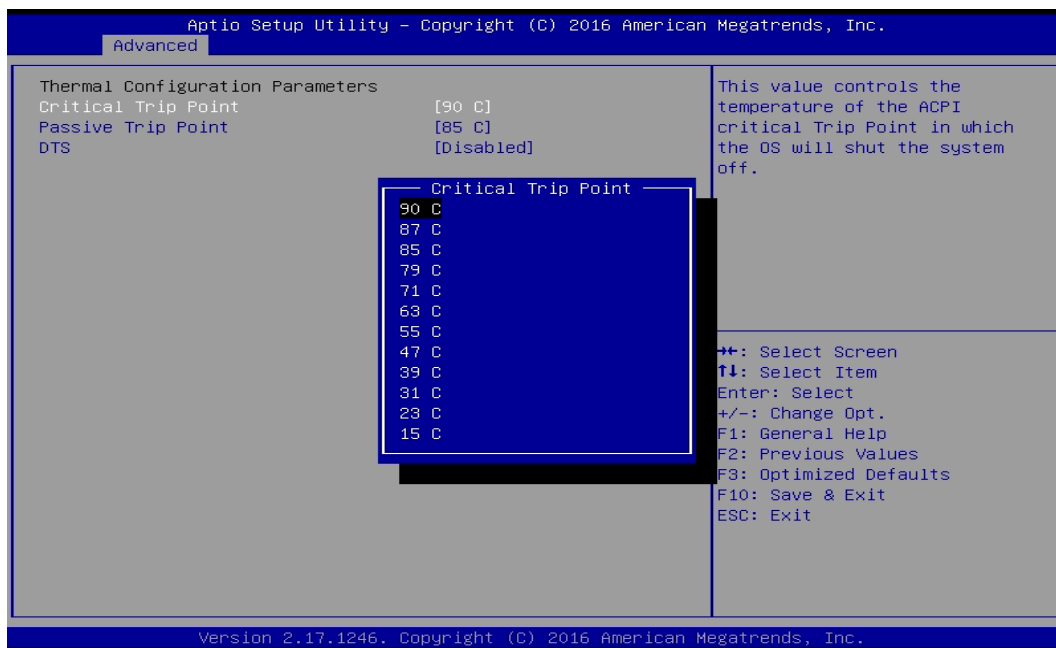

■ Critical Trip Point

Allows user to set the CPU temperature threshold. If the CPU temperature reaches this value, the operating system will shut down the system. This item is configurable only when DTS is enabled.

■ Passive Trip Point

Allows user to set the CPU temperature threshold. If the CPU temperature reaches this value, the CPU frequency will be automatically reduced. This item is configurable only when DTS is enabled.

■ DTS

Enables or disables the CPU overheating protection function. (Default: Disabled)

4.3.7 SATA Configuration

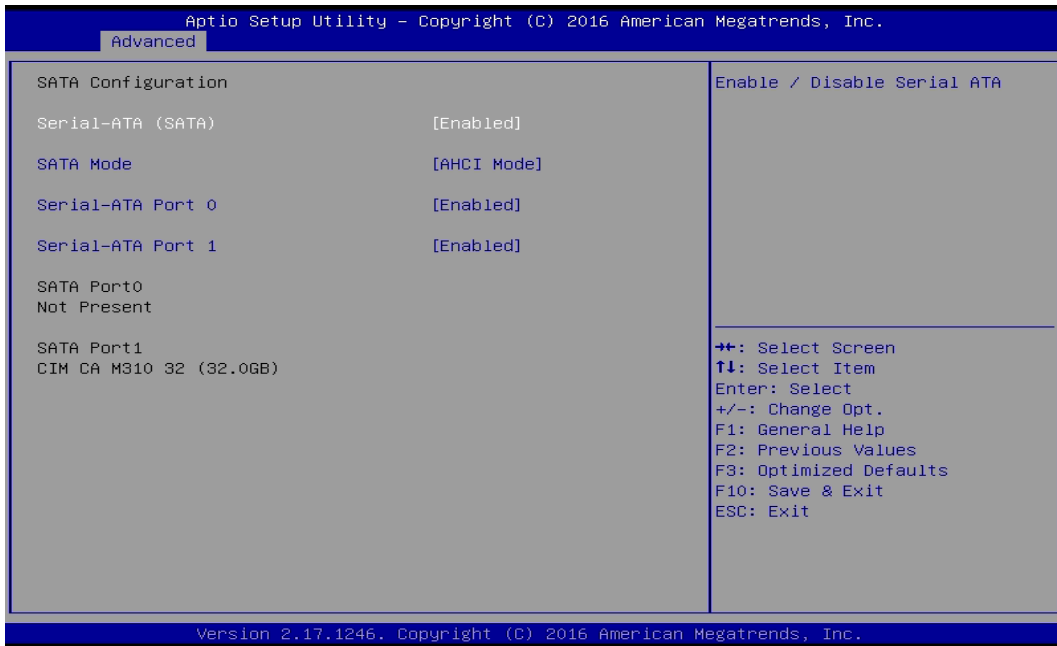

■ Serial-ATA (SATA)

This item will allow users to enable or disable Serial ATA.

■ SATA Mode

This item will allow users to select IDE or AHCI Mode.

■ Serial – ATA Port 0

This item will allow users to enable or disable Serial-ATA Port 0.

■ Serial – ATA Port 1

This item will allow users to enable or disable Serial-ATA Port 1.

4.3.8 OS Selection

This allows you to configure Windows OS version to install. The purpose of this is to enable USB 3.0 controller interface. If you set Windows 7 and install the OS, you will need to install USB 3.0 driver at the OS level to fully support USB 3.0 interfaces. If you set Windows 8.x and install it or later OS, the Windows OS will easily support USB 3.0 interfaces.

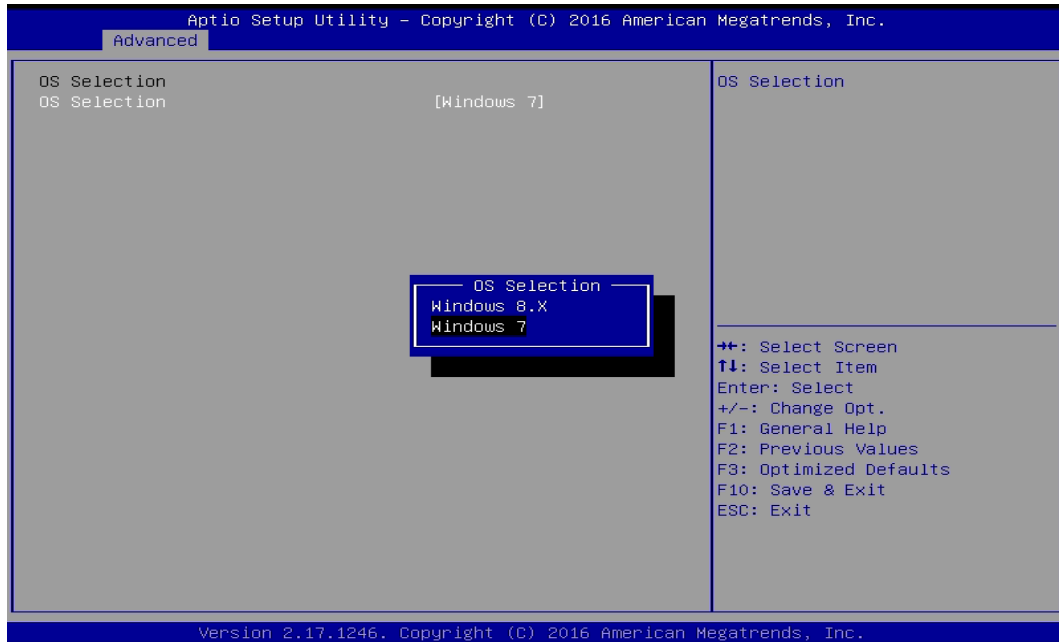

■ OS Selection

This allows to set Windows 8.x or Windows 7 (default).

4.3.9 Compatibility Support Module Configuration

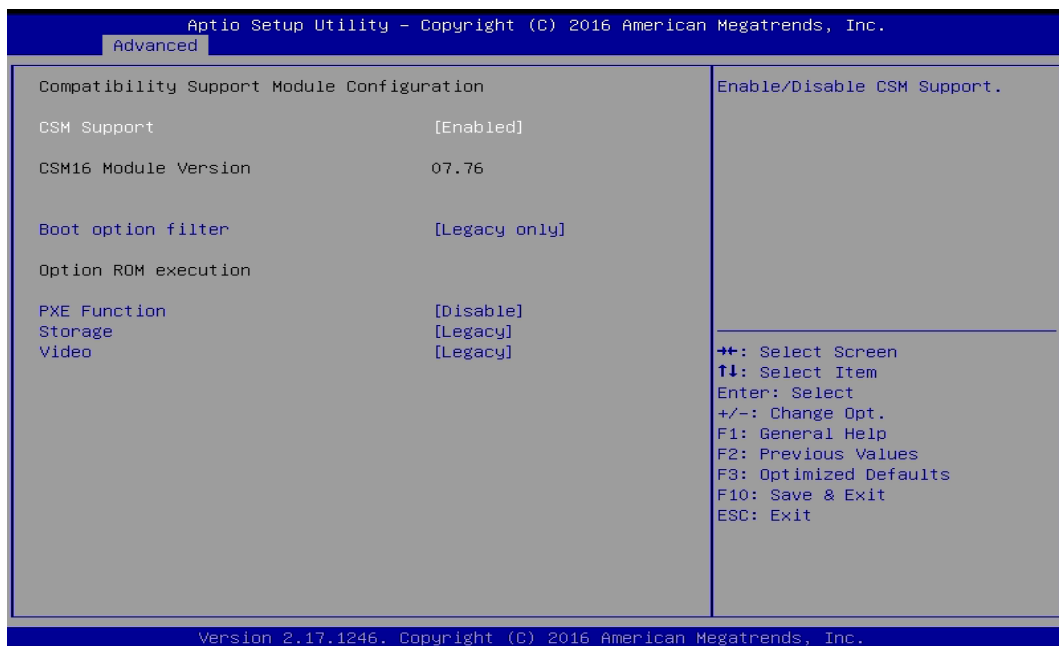

■ CSM Support

Enables or disables UEFI CSM (Compatibility Support Module) to support a legacy PC boot process.

■ Boot option filter

Allows user to select which type of operating system to boot.

UEFI and Legacy: Allows booting from operating systems that support legacy option ROM or UEFI option ROM.

Legacy only: Allows booting from operating systems that only support legacy option ROM.

UEFI only: Allows booting from operating systems that only support UEFI option ROM.

This item is configurable only when CSM Support is set to Enabled.

■ PXE Function

This item will allow users to enable or disable PXE function.

■ Storage

Allows user to select whether to enable the UEFI or legacy option ROM for the Storage device controller.

Do not launch: Disables option ROM.

UEFI only: Enables UEFI option ROM only.

Legacy only: Enables legacy option ROM only.

■ Video

Allows user to select whether to enable the UEFI or legacy option ROM for the Video device controller.

Do not launch: Disables option ROM.

UEFI only: Enables UEFI option ROM only.

Legacy only: Enables legacy option ROM only.

4.3.10 USB Configuration

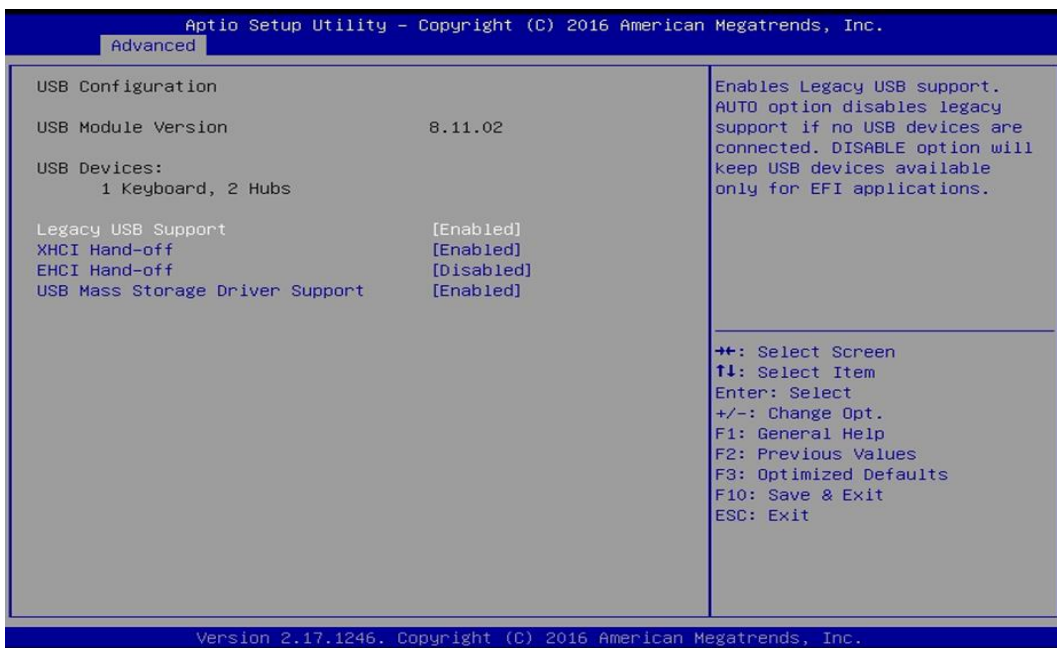

■ Legacy USB Support

Allows USB keyboard/ mouse to be used in MS-DOS.

■ **XHCI Hand-off**

Determines whether to enable XHCI (USB3.0) Hand-off feature for an operating system without XHCI (USB3.0) Hand-off support.

■ **EHCI Hand-off**

Determines whether to enable EHCI Hand-off feature for an operating system without EHCI Hand-off support.

■ **USB Mass Storage Driver Support**

Enables or disables support for USB storage devices.

4.4 Chipset Setup

This section allows you to configure chipset related settings according to user's preference.

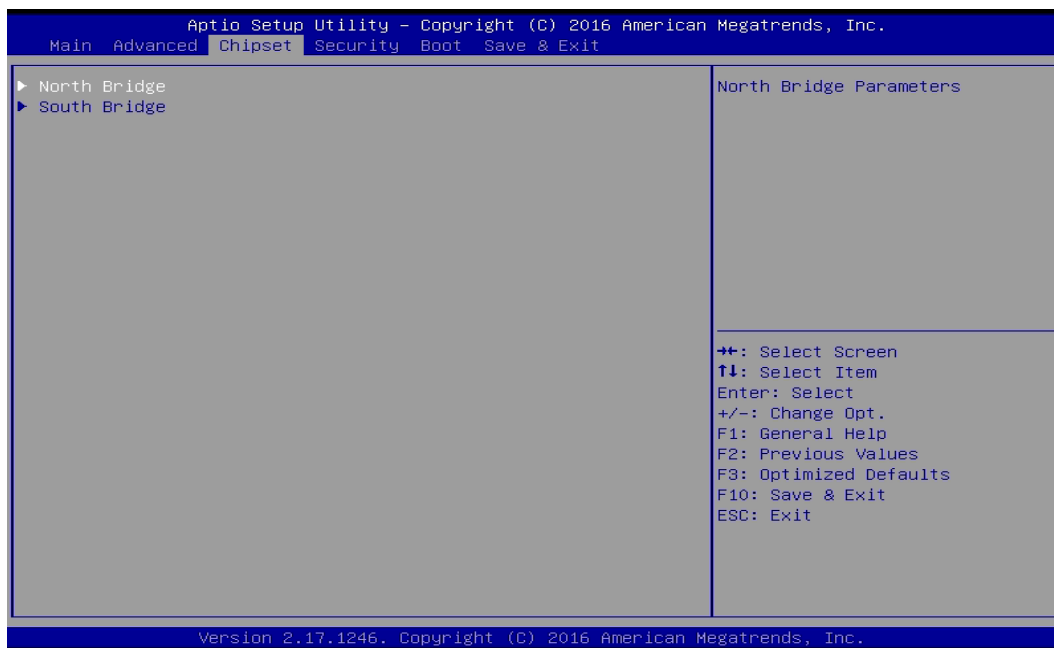

4.4.1 North Bridge

This section provides information on the installed memory size and memory/onboard graphics-related configuration options.

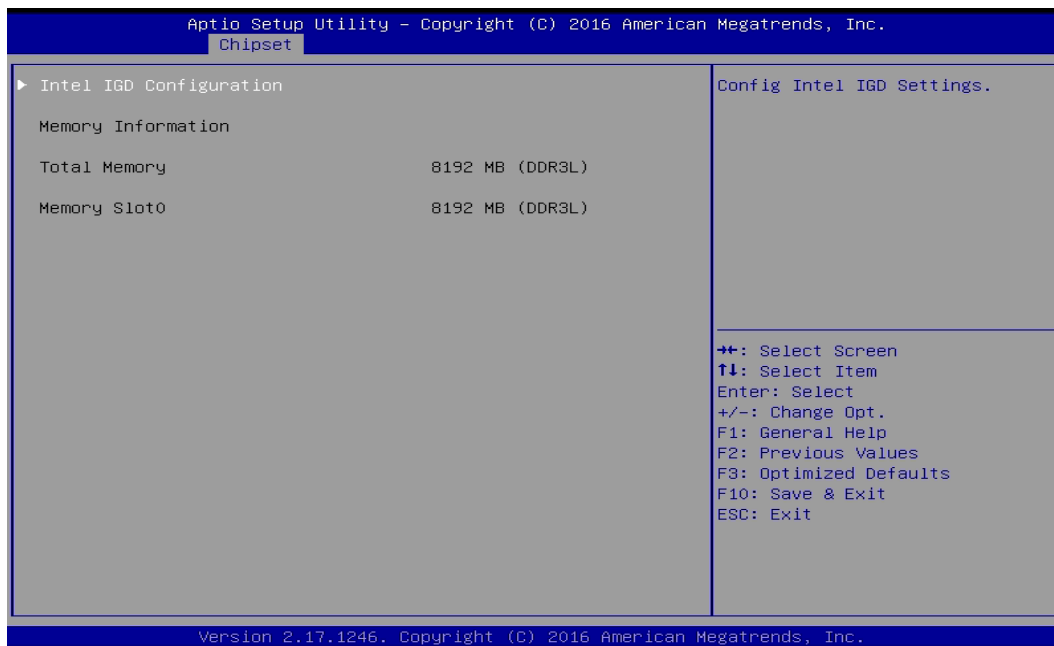

■ Intel IGD Configuration

This section provides onboard graphics-related configuration options.

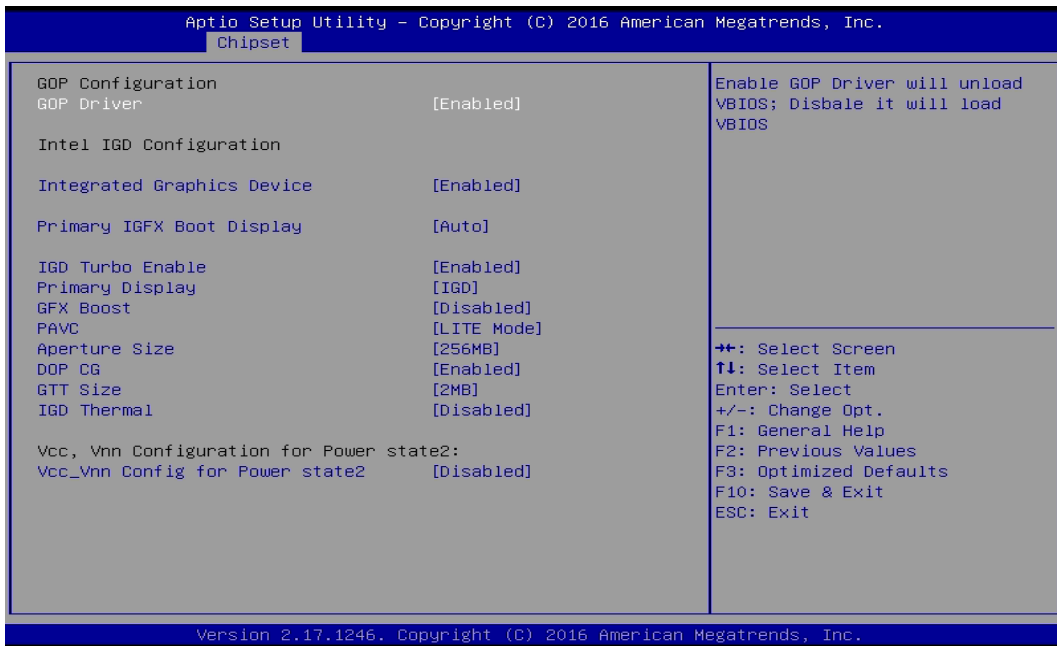

GOP Driver

This item will allow users to enable or disable GOP Driver.

Integrated Graphics Device

This item will allow users to enable or disable Integrated Graphics Device.

IGD Turbo Enable

This item will allow users to enable or disable IGD Turbo.

Primary Display

"Auto or IGFX or PEG or PCIE or SG" optimal to Primary Display.

GFX Boost

This item will allow users to enable or disable GFX Boost.

Aperture Size

Aperture size optimal between 128MB, 256MB, or 512MB.

DOP CG

This item will allow users to enable or disable DOP CG.

GTT Size

GTT size optimal between 1MB or 2MB.

IGD Thermal

This item will allow users to enable or disable IGD Thermal.

4.4.2 South Bridge

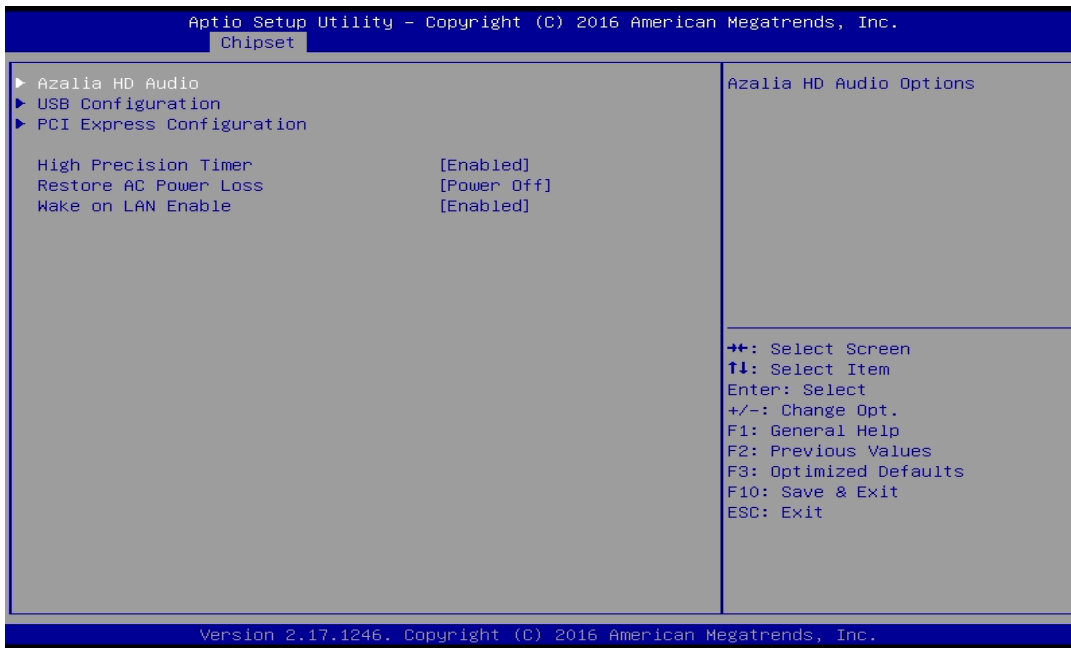

■ Azalia HD Audio

Control detection of the Azalia device.

Audio Controller

Enabled: Azalia will be unconditionally enabled.

Disabled: Azalia will be unconditionally disabled.

■ USB Configuration

XHCI Mode

This setting disables/enables the USB XHCI controller. The eXtensible Host Controller Interface (XHCI) is a computer interface specification that defines a register-level description of a Host Controller for Universal Serial Bus (USB), which is capable of interfacing to USB 1.0, 2.0, and 3.0 compatible devices. The specification is also referred to as the USB 3.0 Host Controller specification.

USB 2.0 (EHCI) Support

This setting disables/enables the USB EHCI controller. The Enhanced Host Controller Interface (EHCI) specification describes the register-level interface for a Host Controller for the Universal Serial Bus (USB) Revision 2.0.

USB RMH Mode

This item will allow users to enable or disable USB RMH Mode.

USB Port 0

This item will allow users to enable or disable USB Port 0.

USB Port 1

This item will allow users to enable or disable USB Port 1.

USB Port 2

This item will allow users to enable or disable USB Port 2.

USB Port 3

This item will allow users to enable or disable USB Port 3.

Wake On LAN Enable

This item enables or disables Wake On LAN (WOL) function.

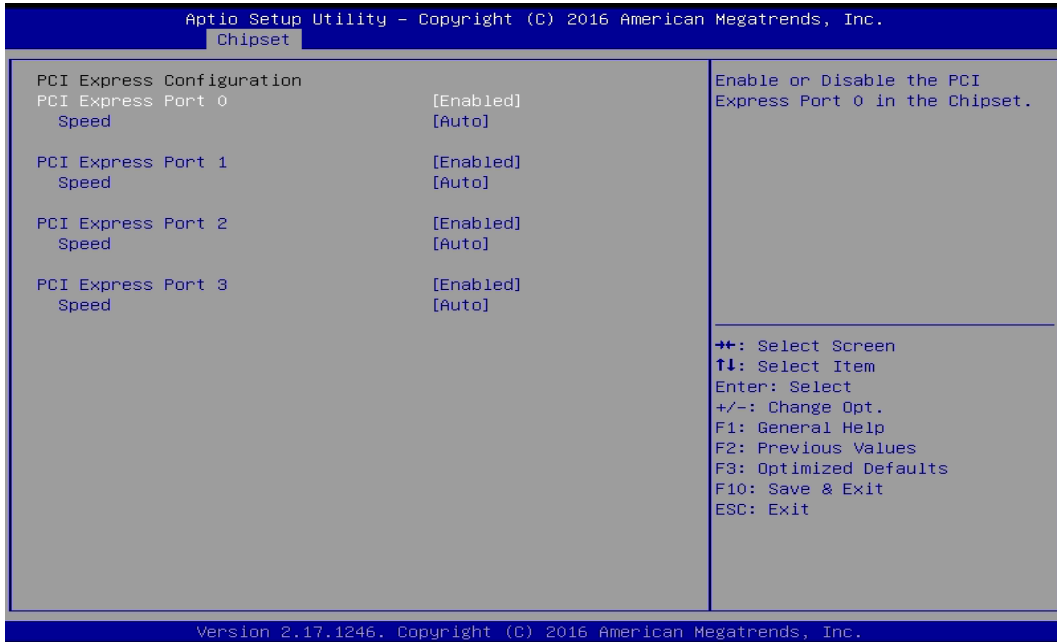

PCI Express Configuration

PCI Express Port 0

This item will allow users to enable or disable PCI Express Port 0.

Speed

Change the PCI Express interface speed. Select <AUTO> ,<Gen 2> or <Gen 1>

PCI Express Port 1

This item will allow users to enable or disable PCI Express Port 1.

Speed

Change the PCI Express interface speed. Select <AUTO> ,<Gen 2> or <Gen 1>

PCI Express Port 2

This item will allow users to enable or disable PCI Express Port 2.

Speed

Change the PCI Express interface speed. Select <AUTO> ,<Gen 2> or <Gen 1>

PCI Express Port 3

This item will allow users to enable or disable PCI Express Port 3.

Speed

Change the PCI Express interface speed. Select <AUTO> ,<Gen 2> or <Gen 1>

High Precision Timer

Enable or disable High Precision Event Timer (HPET) in the operating system.

Restore AC Power Loss

This setting specifies whether your system will reboot after a power failure or interrupt occurs. Available settings are:

Power Off: Leave the computer in the power off state.

Power On: Leave the computer in the power on state.

Last State: Restore the system to the previous status before power failure or interrupt occurred.

4.5 Security Setup

This section allows users to configure BIOS security settings.

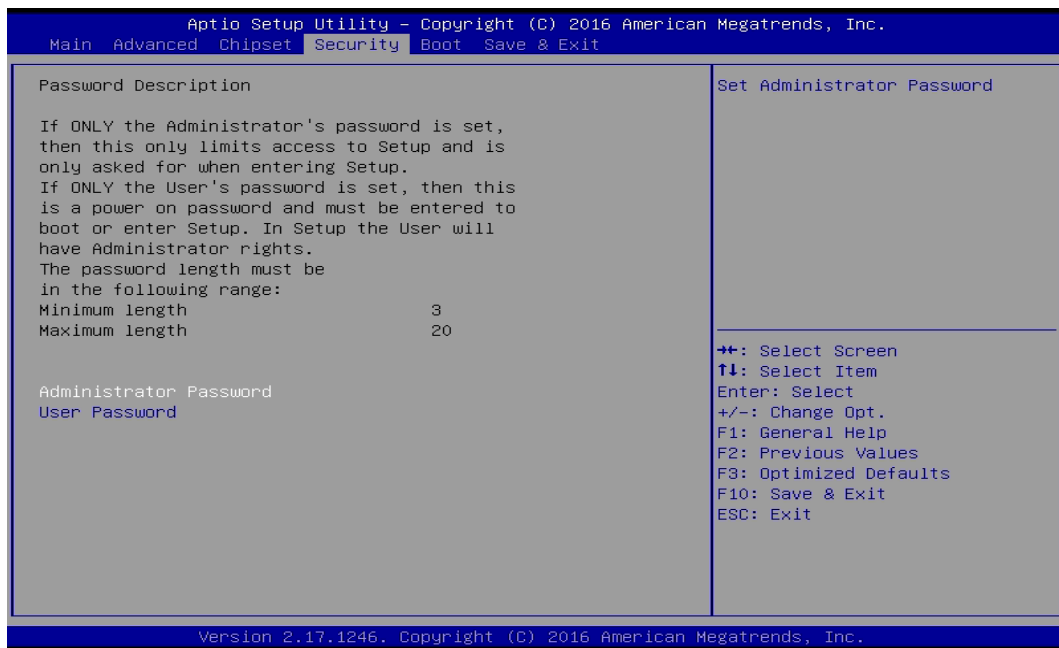

4.5.1 Administrator Password

Administrator Password controls access to the BIOS Setup utility.

4.5.2 User Password

User Password controls access to the system at boot and to the BIOS Setup utility.

4.6 Boot Setup

This section allows you to configure Boot settings.

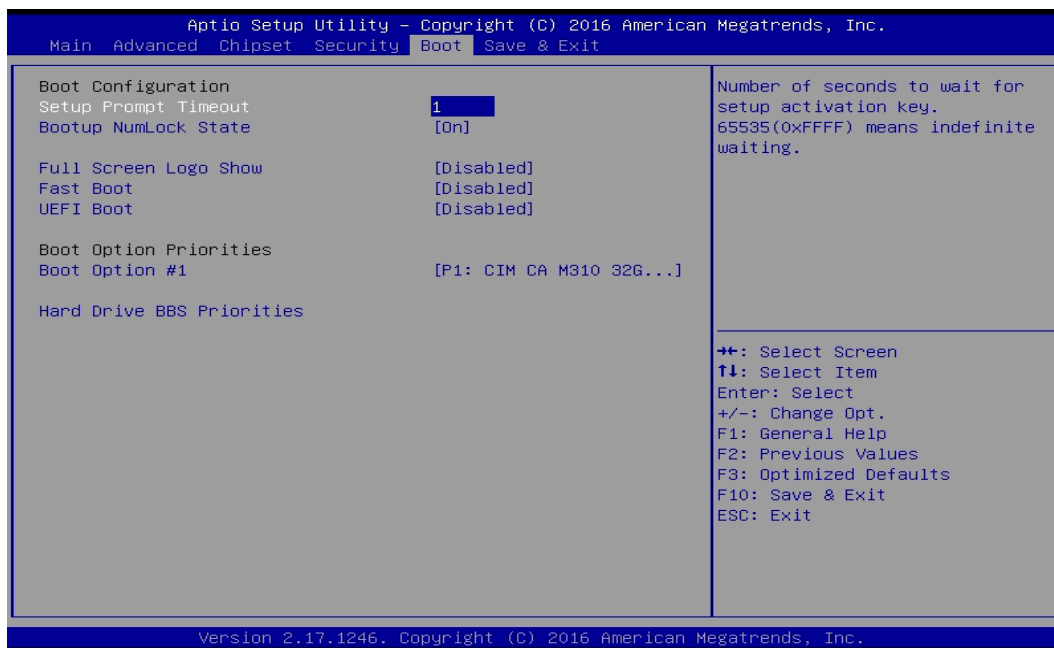

4.6.1 Setup Prompt Timeout

Use this item to set number of seconds to wait for setup activation key.

4.6.2 Bootup NumLock State

Allows users to select the power-on state for keyboard NumLock.

4.6.3 Full Screen Logo Show

This item allows user to enable or disable full screen logo show.

4.6.4 Fast Boot

This item allows user to enable or disable Fast Boot option.

4.6.5 UEFI Boot

This item allows user to enable or disable UEFI Boot option.

4.7 Save & Exit

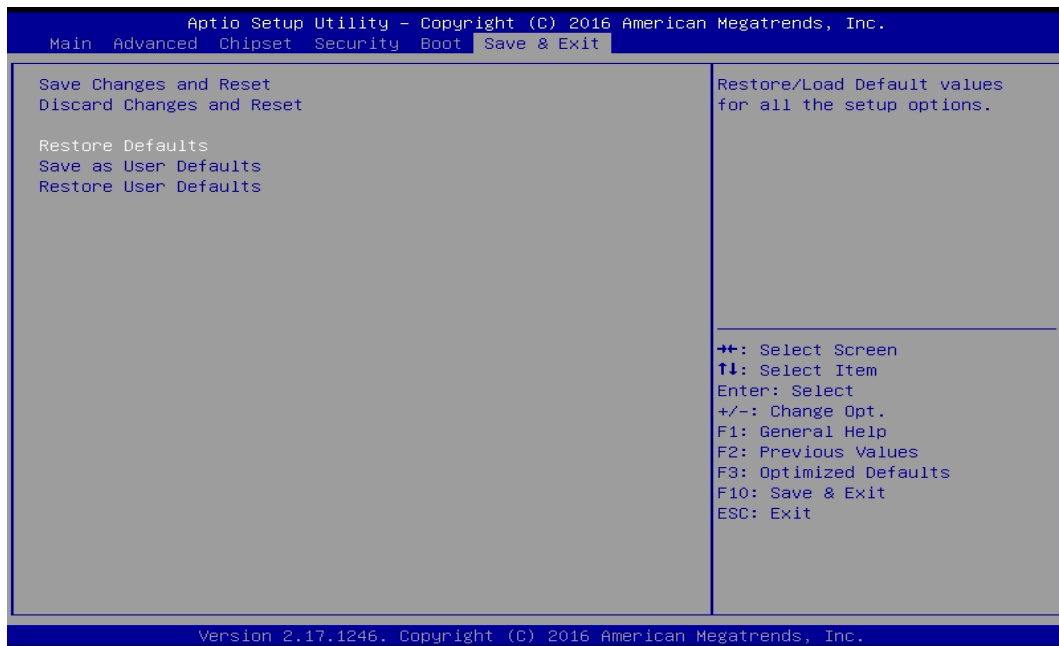

4.7.1 Save Changes and Reset

This item allows user to reset system setup after saving changes.

4.7.2 Discard Changes and Reset

This item allows users to reset system setup without saving any changes.

4.7.3 Restore Defaults

This item allows user to restore/ load default values for all the options.

4.7.4 Save as User Defaults

This item allows users to save the changes done so far as user defaults.

4.7.5 Restore User Defaults

This item allows users to restore the user defaults to all the options.



Chapter 5

Product Application

5.1 Digital I/O (DIO) application

This section describes DIO application of the product. The content and application development are better understood and implemented by well experienced professionals or developers.

5.1.1 Digital I/O Programming Guide

5.1.1.1 Pins for Digital I/O of Cincoze P1001 series product

Item	Standard
GPIO74 (Pin107)	DI
GPIO75 (Pin108)	
GPIO76 (Pin109)	
GPIO77 (Pin110)	
GPIO80 (Pin111)	DO
GPIO81 (Pin112)	
GPIO82 (Pin113)	
GPIO83 (Pin114)	

5.1.1.2 Programming Guide

To program the Super I/O chip F81866A configuration registers, the following configuration procedures must be followed in sequence:

- (1) Enter the Extended Function Mode
- (2) Configure the configuration registers
- (3) Exit the Extended Function Mode

The configuration register is used to control the behavior of the corresponding devices. To configure the register, use the index port to select the index and then write data port to alter the parameters. The default index port and data port are 0x4E and 0x4F, respectively. **To enable configuration, the entry key 0x87 must be written to the index port. To disable configuration, write exit entry key 0xAA to the index port.** Following is an example to enable configuration and to disable configuration by using debug.

```
-o 4e 87
```

- o 4e 87 (enable configuration)
- o 4e aa (disable configuration)

5.1.1.3 Relative Registers

To program the F81866A configuration registers, see the following configuration procedures.

Logic Device Number Register (LDN) — Index 07h

Bit	Name	R/W	Reset	Default	Description
7-0	LDN	R/W	LRESET#	00h	00h: Select FDC device configuration registers. 03h: Select Parallel Port device configuration registers. 04h: Select Hardware Monitor device configuration registers. 05h: Select KBC device configuration registers. 06h: Select GPIO device configuration registers. 07h: Select WDT device configuration registers. 0Ah: Select PME, ACPI and ERP device configuration registers. 10h: Select UART1 device configuration registers. 11h: Select UART2 device configuration registers. 12h: Select UART3 device configuration registers. 13h: Select UART4 device configuration registers. 14h: Select UART5 device configuration registers. 15h: Select UART6 device configuration registers. Otherwise: Reserved.

7.7.11.1GPIO7 Output Enable Register — Index 80h

Bit	Name	R/W	Reset	Default	Description
7	GPIO77_OE	R/W	LRESET#	0	0: GPIO77 is in input mode. 1: GPIO77 is in output mode.
6	GPIO76_OE	R/W	LRESET#	0	0: GPIO76 is in input mode. 1: GPIO75 is in output mode.
5	GPIO75_OE	R/W	LRESET#	0	0: GPIO75 is in input mode. 1: GPIO75 is in output mode.
4	GPIO74_OE	R/W	LRESET#	0	0: GPIO74 is in input mode. 1: GPIO74 is in output mode.

7.7.11.3GPIO7 Pin Status Register — Index 82h (This byte could be also read by base address + 3)

Bit	Name	R/W	Reset	Default	Description
7	GPIO77_IN	R	-	-	The pin status of GPIO77/STB#.
6	GPIO76_IN	R	-	-	The pin status of GPIO76/AFD#.
5	GPIO75_IN	R	-	-	The pin status of GPIO75/ERR#.
4	GPIO74_IN	R	-	-	The pin status of GPIO74/INIT#.

7.7.12.1 GPIO8 Output Enable Register — Index 88h

3	GPIO83_OE	R/W	LRESET#	1	0: GPIO83 is in input mode. 1: GPIO83 is in output mode.
2	GPIO82_OE	R/W	LRESET#	1	0: GPIO82 is in input mode. 1: GPIO82 is in output mode.
1	GPIO81_OE	R/W	LRESET#	1	0: GPIO81 is in input mode. 1: GPIO81 is in output mode.
0	GPIO80_OE	R/W	LRESET#	1	0: GPIO80 is in input mode. 1: GPIO80 is in output mode.

3	GPIO83_VAL	R/W	LRESET#	1	0: GPIO83 outputs 0 when in output mode. 1: GPIO83 outputs 1 when in output mode.
2	GPIO82_VAL	R/W	LRESET#	1	0: GPIO82 outputs 0 when in output mode. 1: GPIO82 outputs 1 when in output mode.
1	GPIO81_VAL	R/W	LRESET#	1	0: GPIO81 outputs 0 when in output mode. 1: GPIO81 outputs 1 when in output mode.
0	GPIO80_VAL	R/W	LRESET#	1	0: GPIO80 outputs 0 when in output mode. 1: GPIO80 outputs 1 when in output mode.

5.1.1.4 Sample Code in C Language

5.1.1.4.1 Control of GP74 to GP77 (DI1 ~ DI4)

```
#define AddrPort 0x4E
```

```
#define DataPort 0x4F
```

<Enter the Extended Function Mode>

```
WriteByte(AddrPort, 0x87)
```

```
WriteByte(AddrPort, 0x87) // Must write twice to enter Extended mode
```

<Select Logic Device>

```
WriteByte(AddrPort, 0x07)
```

```
WriteByte(dataPort, 0x06) // Select logic device 06h
```

<Input Mode Selection> // Set GP74 to GP77 input Mode

```
WriteByte(AddrPort, 0x80) // Select configuration register 80h
```

```
WriteByte(DataPort, 0x0X) // Set (bit 4~7) = 0 to select GP 74~77 as Input mode.
```

<Input Value>

```
WriteByte(AddrPort, 0x82) // Select configuration register 82h
```

```
ReadByte(DataPort, Value) // Read bit 4~7 (0xFF)= GP74 ~77 as High.
```

<Leave the Extended Function Mode>

```
WriteByte(AddrPort, 0xAA)
```

5.1.1.4.2 Control of GP80 to GP83 (DO1 ~ DO4)

```
#define AddrPort 0x4E
```

```
#define DataPort 0x4F
```

<Enter the Extended Function Mode>

```
WriteByte(AddrPort, 0x87)
```

```
WriteByte(AddrPort, 0x87) // Must write twice to enter Extended mode
```

<Select Logic Device>

```
WriteByte(AddrPort, 0x07)
```

```
WriteByte(DataPort, 0x06) // Select logic device 06h
```

<Output Mode Selection> // Set GP80 to GP83 output Mode

```
WriteByte(AddrPort, 0x88) // Select configuration register 88h
```

```
WriteByte(DataPort, 0xFF) // Set (bit 0~3) = 1 to select GP 80 ~83 as Output mode.
```

<Output Value>

```
WriteByte(AddrPort, 0x89) // Select configuration register 89h
```

```
WriteByte(DataPort, Value) // Set bit 0~3=(0/1) to output GP 80~83 as Low or High
```

<Leave the Extended Function Mode>

```
WriteByte(AddrPort, 0xAA)
```

5.1.1.5 Change base address - DIO base address (Cincoze default 0xA00)

<Enter the Extended Function Mode>

```
WriteByte(AddrPort, 0x87)
```

```
WriteByte(AddrPort, 0x87) // Must write twice to enter Extended mode
```

<Select Logic Device>

```
WriteByte(AddrPort, 0x07)
```

```
WriteByte(dataPort, 0x06) // Select logic device 06h
```

```
WriteByte(AddrPort, 0x60) // Select configuration register 60h (High Byte address)
```

```
WriteByte(DataPort, (0x0A))
```

```
WriteByte(AddrPort, 0x61) // Select configuration register 61h (Low Byte address)
```

```
WriteByte(DataPort, (0x00))
```

<Leave the Extended Function Mode>

```
WriteByte(AddrPort, 0xAA)
```

Note: Cincoze DIO Port base address is 0x0A00h.

5.1.1.6 DATA Bit Table (DIO)

7	6	5	4	3	2	1	0	bit
0	0	0	1	-	-	-	-	value
1				X				/h

= DI1

7	6	5	4	3	2	1	0	bit
-	-	-	-	0	0	0	1	value
X				1				/h

= DO1

7	6	5	4	3	2	1	0	bit
0	0	1	0	-	-	-	-	value
2				X				/h

= DI2

7	6	5	4	3	2	1	0	bit
-	-	-	-	0	0	1	0	value
X				2				/h

= DO2

7	6	5	4	3	2	1	0	bit
0	1	0	0	-	-	-	-	value
4				X				/h

= DI3

7	6	5	4	3	2	1	0	bit
-	-	-	-	0	1	0	0	value
X				4				/h

= DO3

7	6	5	4	3	2	1	0	bit
1	0	0	0	-	-	-	-	value
8				X				/h

= DI4

7	6	5	4	3	2	1	0	bit
-	-	-	-	1	0	0	0	value
X				8				/h

= DO4

5.1.1.7 DIO I/O Port Address

DI4	DI3	DI2	DI1	DO4	DO3	DO2	DO1	Pin Definition
7	6	5	4	3	2	1	0	Data Bits
DI				DO				DIO
0xA03				0xA02				I/O Port address

5.2 Digital I/O (DIO) Hardware Specification

- XCOM+: Isolated power in V+
- XCOM-: Isolated power in V-
- Isolated power in DC voltage: 9-30V
- 4x Digital Input (Source Type)
- Input Signal Voltage Level
 - Signal Logic 0: XCOM+ = 9V, $\text{Signal Low} - \underline{V-} < 1\text{V}$
 $\text{XCOM+} > 9\text{V}, \quad \underline{V+} - \text{Signal Low} > 8\text{V}$
 - Signal Logic 1: $> \underline{\text{XCOM+}} - \underline{3\text{V}}$
- Input Driving Sink Current:
 - Minimal: 1 mA
 - Normal: 5 mA
- 4x Digital Output (Open Drain)
 - DO Signal have to pull up resistor to XCOM+ for external device, the resistance will affect the pull up current
 - Signal High Level: Pull up resistor to XCOM+
 - Signal Low Level: = XCOM-
 - Sink Current: 1A (Max)



DIO1: Digital Input / Output Connector

Connector Type: Terminal Block 1X10 10-pin, 3.5mm pitch

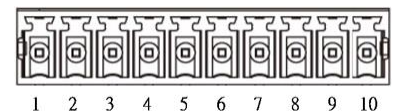
Pin	Definition	Pin	Definition
1	DC INPUT	6	DO1
2	DI1	7	DO2
3	DI2	8	DO3
4	DI3	9	DO4
5	DI4	10	GND

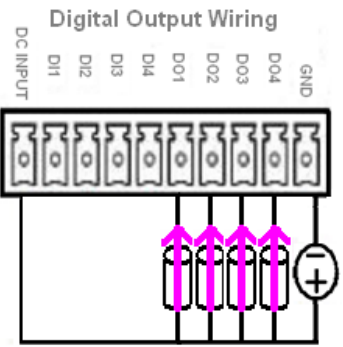
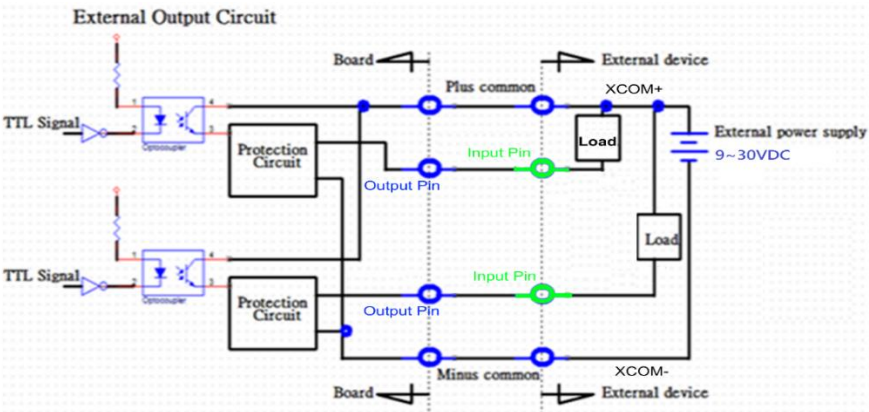
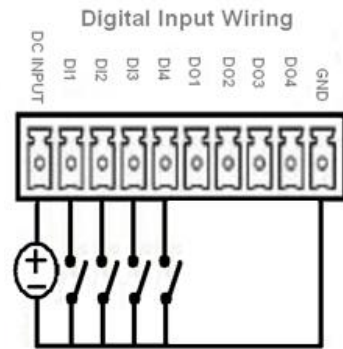
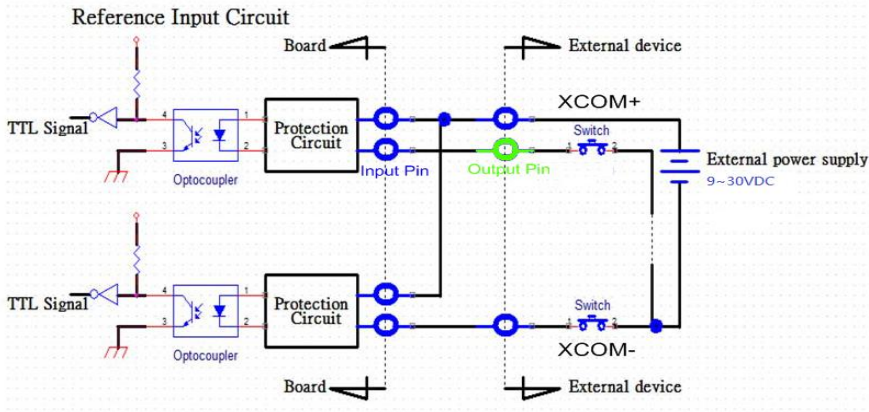





Chapter 6

Optional Accessories

6.1 Installing VESA Mount

Before the installation of VESA mount, user need to follow the chapter 3.13 to disassemble the mounting brackets on the CO display module first.

P1000 series supports VESA mounting that customer can mount system with panel complying with VESA 75mm and 100 mm standard for various usage. The 75mm VESA uses blue-circle-marked screw holes. The 100mm VESA uses red-circle-marked screw holes.

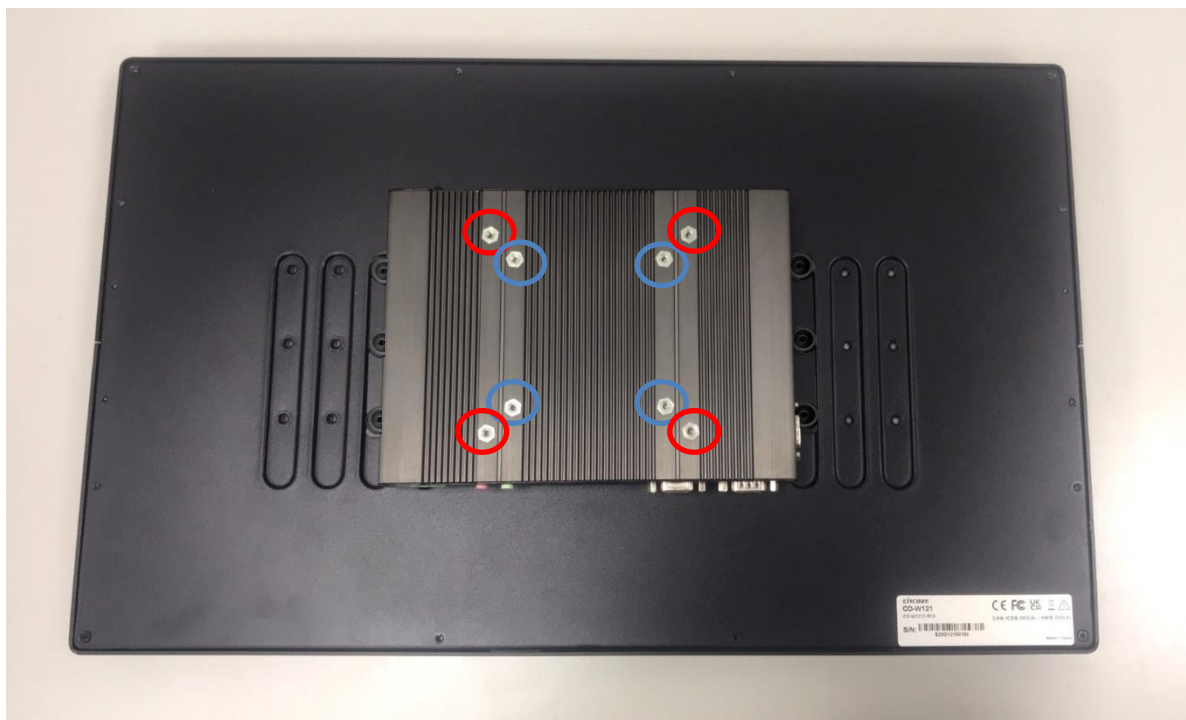

1. Put the VESA stand on, and align with the mounting holes.



2. Fasten the VESA mount screws to complete the VESA mounting.



6.2 Installing Rack Mount

Before the installation of rack mount, user need to follow the chapter 3.13 to disassemble the mounting brackets on the CO display module first.

1. Locate the screw holes on the PC or monitor module.

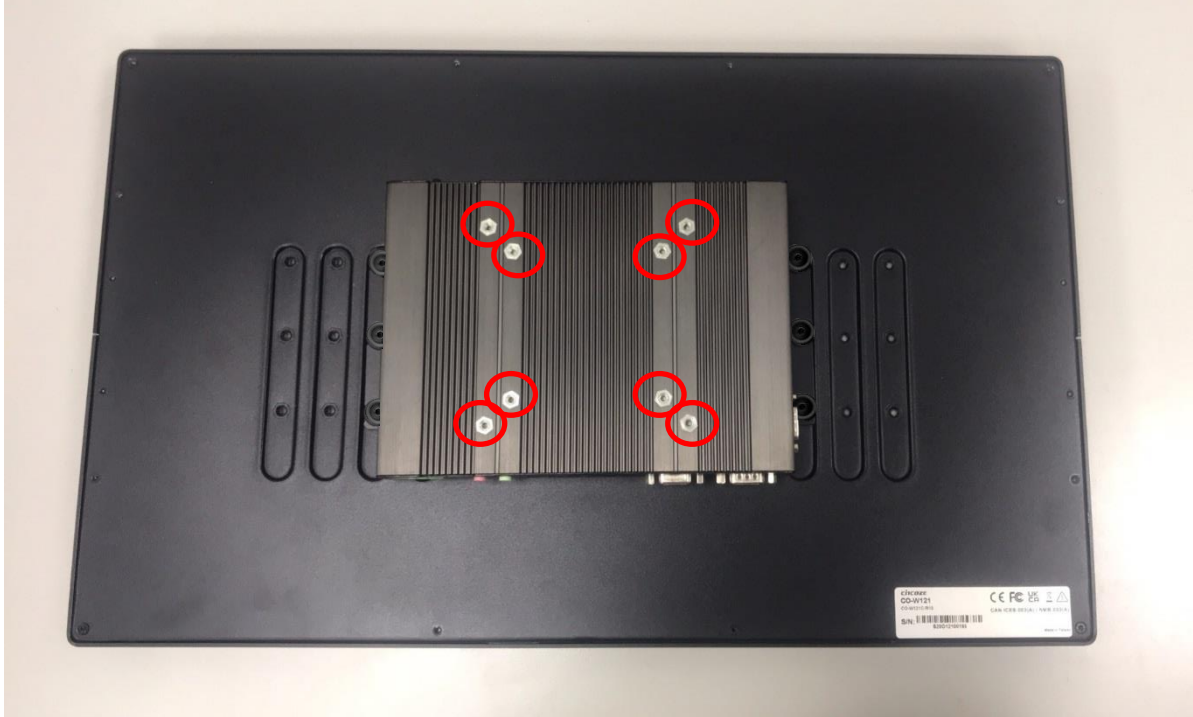

2. Put on the rack mount base and fasten the screws.

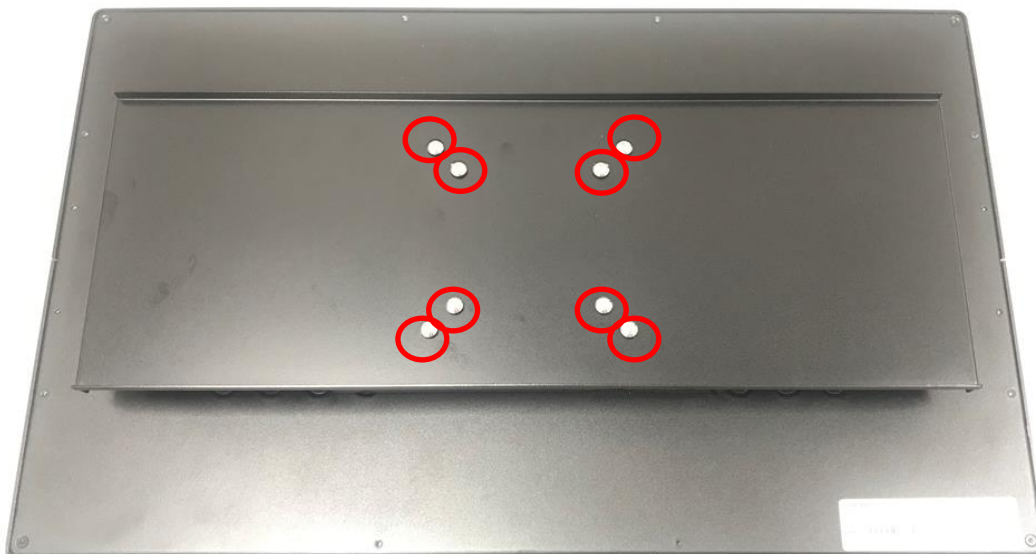

3. Assemble two rack mount brackets by fastening 4 screws (M5x6) at each side.

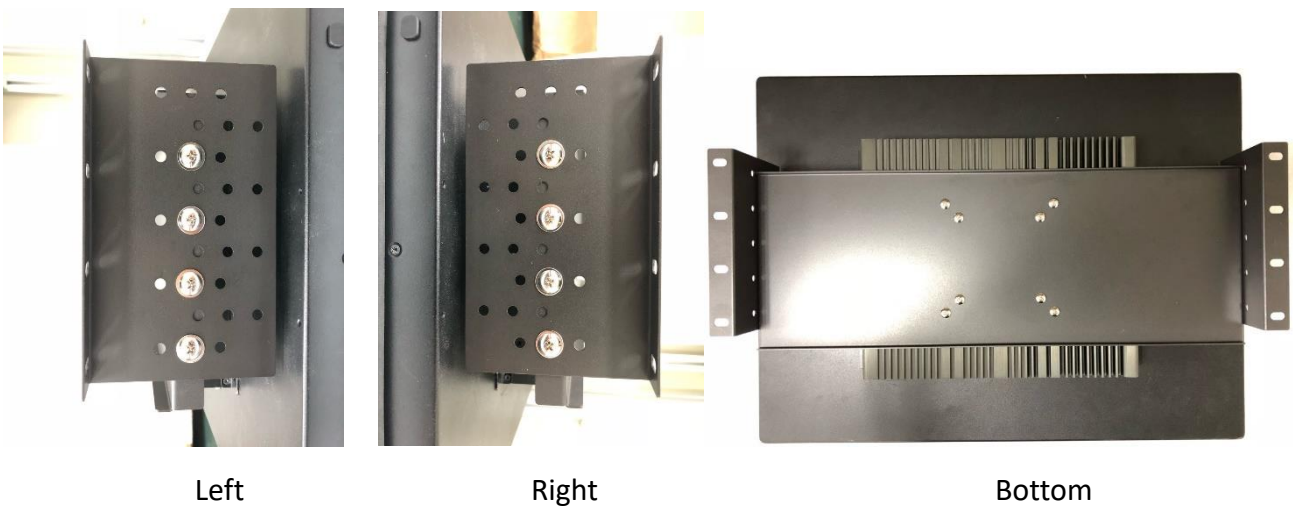
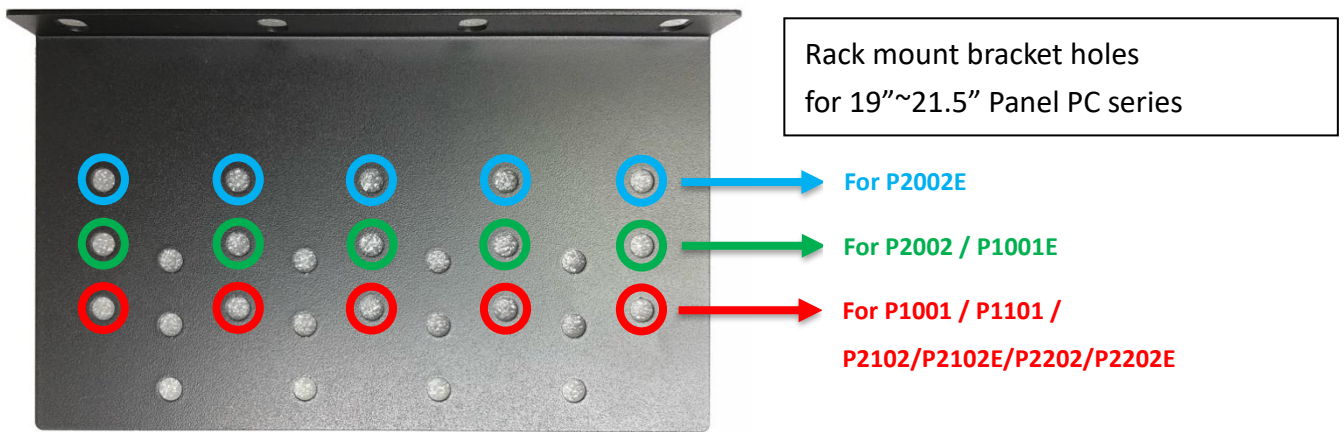

4. Assemble two rack mount brackets by fastening 4 screws (M5x12), flat washers and hex nuts at each side.



cincoze

© 2022 Cincoze Co., Ltd. All rights reserved.

The Cincoze logo is a registered trademark of Cincoze Co., Ltd.

All other logos appearing in this catalog are the intellectual property of the respective company, product, or organization associated with the logo.

All product specifications and information are subject to change without notice.