

chcoze

DS-1300 Series

User Manual



Rugged Embedded Computer

10th Generation Intel® Xeon/Core™ Series Processors, High Performance,
Expandable and Modular Rugged Embedded Computer

Contents

Preface	6
Revision.....	6
Copyright Notice.....	6
Acknowledgement.....	6
Disclaimer	7
Declaration of Conformity	7
Product Warranty Statement	7
Technical Support and Assistance	8
Conventions Used in this Manual.....	9
Safety Precautions	9
Ordering information.....	11
Package Checklist	11
Chapter 1 Product Introductions	12
1.1 Overview	13
1.2 Highlights.....	13
1.3 Product Pictures.....	15
1.4 Key Features.....	18
1.5 Hardware Specification	19
1.6 System I/O.....	23
1.7 Mechanical Dimension.....	27
Chapter 2 Switches & Connectors	29
2.1 Location of Switches and Connectors.....	30
2.1.1 Top View	30
2.1.2 Bottom View	31
2.2 Switches and Connectors Definition	32
2.3 Definition of Switches	34
2.4 Definition of Connectors.....	36
Chapter 3 System Setup	43
3.1 Removing Top Cover	44
3.2 Installing CPU	46
3.3 Installing SO-DIMM	48
3.4 Installing Mini-PCIe Card.....	50
3.5 Installing M.2 M Key Card	52
3.6 Installing Antenna	53
3.7 Installing Antenna Cutout Universal Bracket (Rear)	55
3.8 Installing Antenna Cutout Universal Bracket (Front).....	56
3.9 Installing SATA Hard Drive on Top Side.....	57
3.10 Installing PCI/PCIe Add-on Card.....	58
3.11 Assembling Top Cover.....	62

3.12 Installing SATA Hard Drives at Front Panel	64
3.13 Installing SIM Card	66
3.14 Replacing CMOS Battery	67
3.15 Installing Wall Mount.....	69
3.16 Connecting to Power Supply.....	71
Chapter 4 BIOS Setup	72
4.1 BIOS Introduction.....	73
4.2 Main Setup.....	74
4.3 Advanced Setup	75
4.3.1 CPU Configuration.....	75
4.3.2 Power & Performance.....	76
4.3.3 SATA Configuration	76
4.3.4 PCH-FW Configuration	77
4.3.5 Trusted Computing.....	78
4.3.6 ACPI Settings	79
4.3.7 F81866 Super IO Configuration.....	80
4.3.8 Hardware Monitor	81
4.3.9 S5 RTC Wake Settings.....	82
4.3.10 Serial Port Console Redirection.....	82
4.3.11 AMI Graphic Output Protocol Policy.....	83
4.3.12 USB Configuration	83
4.3.13 Network Stack Configuration	84
4.3.14 CSM Configuration	85
4.3.15 NVMe Configuration	86
4.4 Chipset Setup	87
4.4.1 System Agent (SA) Configuration	87
4.4.2 PCH-IO Configuration	89
4.5 Security Setup	92
4.5.1 Administrator Password	92
4.5.2 User Password	92
4.5.3 Security Boot	92
4.6 Boot Setup.....	93
4.6.1 Setup Prompt Timeout [1].....	93
4.6.2 Bootup NumLock State [Off]	93
4.6.3 Quiet Boot [Disabled]	93
4.6.4 Fast Boot [Disabled]	93
4.7 Save & Exit.....	94
4.7.1 Save Changes and Exit	94
4.7.2 Discard Changes and Exit.....	94
4.7.3 Save Changes and Reset.....	94
4.7.4 Discard Changes and Reset.....	94

4.7.5	Save Changes	94
4.7.6	Discard Changes	94
4.7.7	Restore Defaults	94
4.7.8	Save as User Defaults	94
4.7.9	Restore User Defaults.....	94
Chapter 5	Product Application.....	95
5.1	Digital I/O (DIO) application.....	96
5.1.1	Digital I/O Programming Guide	96
5.2	DIO Hardware Specification.....	109
5.2.1	DIO Connector Definition	110
5.3	GPIO LED application	113
5.3.1	GPIO LED Programming Guide	113
5.4	GPIO LED Status Definition	119
Chapter 6	Optional Modules & Accessories	120
6.1	Optional Module Pin Definition & Settings.....	121
6.1.1	CMI-2P5GLAN03/ UB1012 Module	121
6.1.2	CMI-10GXM12LAN03/ UB1037 Module.....	121
6.1.3	CMI-M12LAN01-R12/UB1010 Module.....	122
6.1.4	CMI-XM12LAN01-R12/UB1030 Module.....	122
6.1.5	CMI-CAN01-R10/UB1038 Module.....	123
6.1.6	CMI-COM02/UB1004 Module	124
6.1.7	CMI-ICOM01/UB1004 Module	125
6.1.8	CFM-IGN101 Module.....	126
6.2	Installing High Speed CMI Module.....	127
6.2.1	CMI-LAN01-R12/UB1012 Module	127
6.2.2	CMI-2P5GLAN03/UB1012 Module	128
6.2.3	CMI-10GXM12LAN03/UB1037 Module	131
6.2.4	CMI-M12LAN01-R12/UB1010 Module.....	135
6.2.5	CMI-XM12LAN01-R10/UB1030 Module.....	137
6.2.6	CMI-10GLAN03-R10/UB1028 Module.....	140
6.2.7	CMI-CAN01-R10/UB1038 Module.....	143
6.3	Installing Low Speed CMI Module.....	145
6.3.1	CMI-DIO02/UB1018 Module	145
6.3.2	CMI-COM02/UB1004 Module	146
6.3.3	CMI-ICOM01/UB1004 Module	148
6.4	Installing CFM Module	150
6.4.1	CFM-PoE03 Module.....	150
6.4.2	CFM-IGN101 Module.....	153
6.5	Installing MEC Module	154
6.5.1	MEC-COM-M212-DB9/UB0303 Module	154
6.5.2	MEC-USB-M102-30/UB0314 Module.....	157

6.5.3 MEC-LAN-M102-30/UB0311 Module.....	160
6.6 Installing External FAN	163
6.7 Installing Internal FAN (For DS-1302 only).....	165

Preface

Revision

Revision	Description	Date
1.00	First Release	2021/06/28
1.01	Add CMI-XM12LAN01-R10 installation steps	2021/07/26
1.02	Correction Made	2021/07/30
1.03	Correction Made	2021/08/10
1.04	Correction Made	2021/08/31
1.05	Correction Made	2021/09/06
1.06	Remove Pentium & Celeron CPU Specification	2021/12/16
1.07	Correction Made	2022/05/31
1.08	Correction Made	2022/06/14
1.09	Correction Made	2022/09/30
1.10	Correction Made	2023/04/14
1.11	MEC-USB Updated	2023/07/31
1.12	Correction Made	2023/09/21
1.13	Spec of Ingress Protection Added	2024/02/22
1.14	Antenna Cutout Universal Bracket (Model No. UB0331) Installation Added	2025/07/04
1.15	Correction Made	2025/09/26
1.16	Added CMI-2P5GLAN, CMI-10GXM12LAN	2025/12/08
1.17	Added UL Certification	2026/01/16
1.18	Added CMI-CAN01	2026/04/28

Copyright Notice

© 2021 by Cincoze Co., Ltd. All rights are reserved. No parts of this manual may be copied, modified, or reproduced in any form or by any means for commercial use without the prior written permission of Cincoze Co., Ltd. All information and specifications provided in this manual are for reference only and remain subject to change without prior notice.

Acknowledgement

Cincoze is a registered trademark of Cincoze Co., Ltd. All registered trademarks and product names mentioned herein are used for identification purposes only and may be trademarks and/or registered trademarks of their respective owners.

Disclaimer

This manual is intended to be used as a practical and informative guide only and is subject to change without notice. It does not represent a commitment on the part of Cincoze. This product might include unintentional technical or typographical errors. Changes are periodically made to the information herein to correct such errors, and these changes are incorporated into new editions of the publication.

Declaration of Conformity



FCC

This equipment has been tested and found to comply with the limits for a Class A digital device, pursuant to Part 15 of the FCC Rules. These limits are designed to provide reasonable protection against harmful interference when the equipment is operated in a commercial environment. This equipment generates, uses, and can radiate radio frequency energy and, if not installed and used in accordance with the instruction manual, may cause harmful interference to radio communications. Operation of this equipment in a residential area is likely to cause harmful interference in which case the user will be required to correct the interference at his own expense.



CE

The product(s) described in this manual complies with all application European Union (CE) directives if it has a CE marking. For computer systems to remain CE compliant, only CE-compliant parts may be used. Maintaining CE compliance also requires proper cable and cabling techniques.



UL

A product that carries the “UL Listed” approval mark means that the product has been tested by UL to nationally recognized Safety Standards and has been found to be free from reasonably foreseeable risk of fire, electric shock and related hazards.

Product Warranty Statement

Warranty

Cincoze products are warranted by Cincoze Co., Ltd. to be free from defect in materials and workmanship for 2 years from the date of purchase by the original purchaser. During the warranty period, we shall, at our option, either repair or replace any product that proves to be defective under normal operation. Defects, malfunctions, or failures of the warranted product caused by damage resulting from natural disasters (such as by lightning, flood, earthquake, etc.), environmental and atmospheric disturbances, other external forces such as power line disturbances, plugging the board in under power, or incorrect cabling, and damage caused by misuse,

abuse, and unauthorized alteration or repair, and the product in question is either software, or an expendable item (such as a fuse, battery, etc.), are not warranted.

RMA

Before sending your product in, you will need to fill in Cincoze RMA Request Form and obtain an RMA number from us. Our staff is available at any time to provide you with the most friendly and immediate service.

■ **RMA Instruction**

- Customers must fill in Cincoze Return Merchandise Authorization (RMA) Request Form and obtain an RMA number prior to returning a defective product to Cincoze for service.
- Customers must collect all the information about the problems encountered and note anything abnormal and describe the problems on the “Cincoze Service Form” for the RMA number apply process.
- Charges may be incurred for certain repairs. Cincoze will charge for repairs to products whose warranty period has expired. Cincoze will also charge for repairs to products if the damage resulted from acts of God, environmental or atmospheric disturbances, or other external forces through misuse, abuse, or unauthorized alteration or repair. If charges will be incurred for a repair, Cincoze lists all charges, and will wait for customer’s approval before performing the repair.
- Customers agree to ensure the product or assume the risk of loss or damage during transit, to prepay shipping charges, and to use the original shipping container or equivalent.
- Customers can be sent back the faulty products with or without accessories (manuals, cable, etc.) and any components from the system. If the components were suspected as part of the problems, please note clearly which components are included. Otherwise, Cincoze is not responsible for the devices/parts.
- Repaired items will be shipped along with a "Repair Report" detailing the findings and actions taken.

Limitation of Liability

Cincoze’ liability arising out of the manufacture, sale, or supplying of the product and its use, whether based on warranty, contract, negligence, product liability, or otherwise, shall not exceed the original selling price of the product. The remedies provided herein are the customer’s sole and exclusive remedies. In no event shall Cincoze be liable for direct, indirect, special or consequential damages whether based on contract of any other legal theory.

Technical Support and Assistance

1. Visit the Cincoze website at www.cincoze.com where you can find the latest information about the product.

2. Contact your distributor or our technical support team or sales representative for technical support if you need additional assistance. Please have following information ready before you call:

- Product name and serial number
- Description of your peripheral attachments
- Description of your software (operating system, version, application software, etc.)
- A complete description of the problem
- The exact wording of any error messages

Conventions Used in this Manual



WARNING
(AVERTIR)

This indication alerts operators to an operation that, if not strictly observed, may result in severe injury.
(Cette indication avertit les opérateurs d'une opération qui, si elle n'est pas strictement observée, peut entraîner des blessures graves.)



CAUTION
(ATTENTION)

This indication alerts operators to an operation that, if not strictly observed, may result in safety hazards to personnel or damage to equipment.
(Cette indication avertit les opérateurs d'une opération qui, si elle n'est pas strictement observée, peut entraîner des risques pour la sécurité du personnel ou des dommages à l'équipement.)



NOTE
(NOTE)

This indication provides additional information to complete a task easily.
(Cette indication fournit des informations supplémentaires pour effectuer facilement une tâche.)

Safety Precautions

Before installing and using this device, please note the following precautions.

1. Read these safety instructions carefully.
2. Keep this User's Manual for future reference.
3. Disconnect this equipment from any AC outlet before cleaning.
4. For plug-in equipment, the power outlet socket must be located near the equipment and must be easily accessible.
5. Keep this equipment away from humidity.
6. Put this equipment on a reliable surface during installation. Dropping it or letting it fall may cause damage.

7. Make sure the voltage of the power source is correct before connecting the equipment to the power outlet.
8. Use a power cord that has been approved for use with the product and that matches the voltage and current marked on the product's electrical range label. The voltage and current rating of the cord must be greater than the voltage and current rating marked on the product.
9. Position the power cord so that people cannot step on it. Do not place anything over the power cord.
10. All cautions and warnings on the equipment should be noted.
11. If the equipment is not used for a long time, disconnect it from the power source to avoid damage from transient overvoltage.
12. Never pour any liquid into an opening. This may cause fire or electrical shock.
13. Never open the equipment. For safety reasons, the equipment should be opened only by qualified service personnel.

If one of the following situations arises, get the equipment checked by service personnel:

- The power cord or plug is damaged.
 - Liquid has penetrated into the equipment.
 - The equipment has been exposed to moisture.
 - The equipment does not work well, or you cannot get it work according to the user's manual.
 - The equipment has been dropped and damaged.
 - The equipment has obvious signs of breakage.
14. CAUTION: Danger of explosion if battery is incorrectly replaced. Replace only with the same or equivalent type recommended by the manufacturer.
 15. Equipment intended only for use in a RESTRICTED ACCESS AREA.
 16. Output of the external power source shall comply with ES1, PS3 requirements, output rating between 9-48 VDC, with minimum rated maximum ambient temperature 60°C, and has to be evaluated according to UL/IEC/EN 60950-1 and/or UL/IEC/EN 62368-1. If you need further assistance, please contact Cincoze for further information.
 17. Ensure to connect the power cord of the power adapter to a socket-outlet with an earth connection.
 18. Dispose of used battery promptly. Keep away from children. Do not disassemble and do not dispose of in fire.

Ordering information

Before installation, please ensure all the items listed in the following table are included in the package. Notify your sales representative if any of the above items are missing or damaged.

Available Models

Model No.	Product Description
DS-1300	10th Generation Intel® Xeon/Core™ Series Processors, High Performance, Expandable and Modular Rugged Embedded Computer
DS-1301	10th Generation Intel Xeon/Core Series Processors, High Performance, Expandable and Modular Rugged Embedded Computer with 1x PCI/PCIe Expansion Slot
DS-1302	10th Generation Intel Xeon/Core Series Processors, High Performance, Expandable and Modular Rugged Embedded Computer with 2 PCI/PCIe Expansion Slot

Package Checklist

Item	Description	Q'ty
1	Heatsink Pack	1
2	Screw Pack	1
3	Wall Mount Kit	1
4	Power Terminal Block Connector	1
5	Remote Function Terminal Block Connector	2
6	Fan Terminal Block Connector	1



Chapter 1

Product Introductions

1.1 Overview

The DS-1300 series is a powerful embedded computer and brings unrivalled performance. It has versatile functionalities and rich industrial I/O. And most importantly, it has one PCI/PCIe expansion capability (DS-1301 and DS-1302). Equipped with Cincoze’s CMI, CFM, MEC modular expansion, customization for additional I/O or other functionality to fulfill different applications couldn’t be easier. The DS-1301 meets the requirements of industrial environments and is certified with industry standards. It delivers ultimate and reliable performance for factory automation, industrial automation and rolling stock applications.

1.2 Highlights



10-CORE & 80W

Workstation Grade Processor Support!

10-Core, Up To 80 W CPU

The DS-1300 series, powered by a workstation-grade 10th-gen Intel® Xeon® or Core™ i9/i7/i5/i3 CPU with up to 10-core architecture, provides superior processing performance. The DS-1300 supports Xeon® CPU up to 80 W TDP. It incorporates DDR4 2933/2666 MHz memory up to 64 GB, delivering unparalleled performance in a rugged, fanless system.

More Powerful & Faster Multiplies Productivity

The DS-1300 series’s 10th-gen CPU brings to 31% better integer multi-tasking for compute-intensive application performance than 9th-gen CPUs*. DDR4 2933 MHz memory further increases speed by 10%**.

* 31% increase for 10th-gen i9-10900E 65W vs 9th-gen i7-9700 65W CPU
** 10% increase for 2933 MHz of DS-1300 vs 2666 MHz of DS-1200.

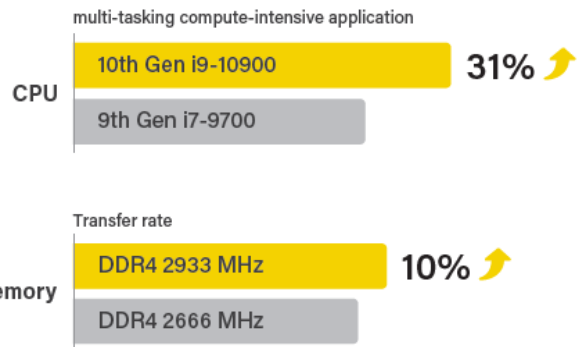

Industrial I/O and Modular Expansion

The DS-1300 series offers a vast array of industrial-focused I/O including up to 2x GbE LAN, 6x USB 3.2, and 2x USB 2.0, 2x RS232/422/485, 2x 2.5" SATA, 3x mSATA, 1x M.2 key M for NVMe SSD, 2x SIM card slots, 3x full-size Mini-PCIe and triple independent displays (DisplayPort, HDMI, VGA). It also features modular expansion through Cincoze’s CMI/CFM modules, adding additional I/O or other functionality such as high-speed 10GbE LAN, PoE, and ignition sensing.

Rugged Reliability Against Rigorous Environments

The DS-1300 series's fanless and cableless industrial-grade design can withstand rigorous environments. Its unique thermal design supports an extended operating temperature range from -40°C to 70°C. It has also passed stringent industry standards, including MIL-STD-810G military standard and EN50155 (EN 50121-3-2 only) for rolling stock environments.

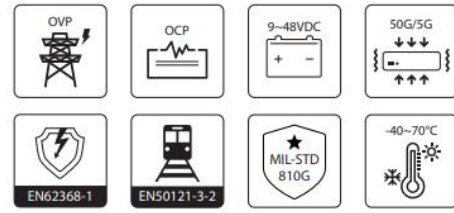
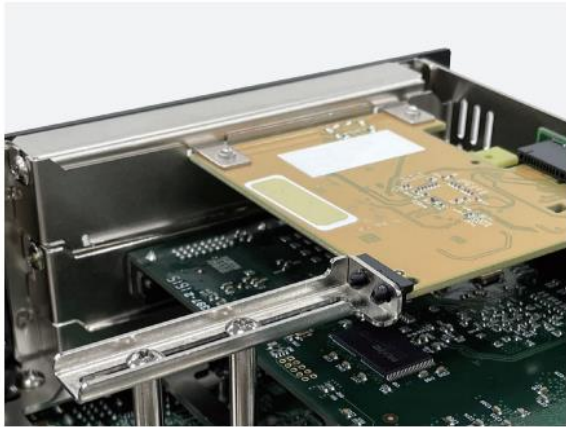

Adjustable PCIe Card Retainer

The PCI/PCIe expansion slot includes an adjustable card retainer that firmly secures the PCI/PCIe add-on card. The retainer is a cool feature that provides the extra protection needed to prevent add-on cards from shaking loose in high-vibration environments like rolling stock.

Patent No. I773359

1.3 Product Pictures

DS-1300

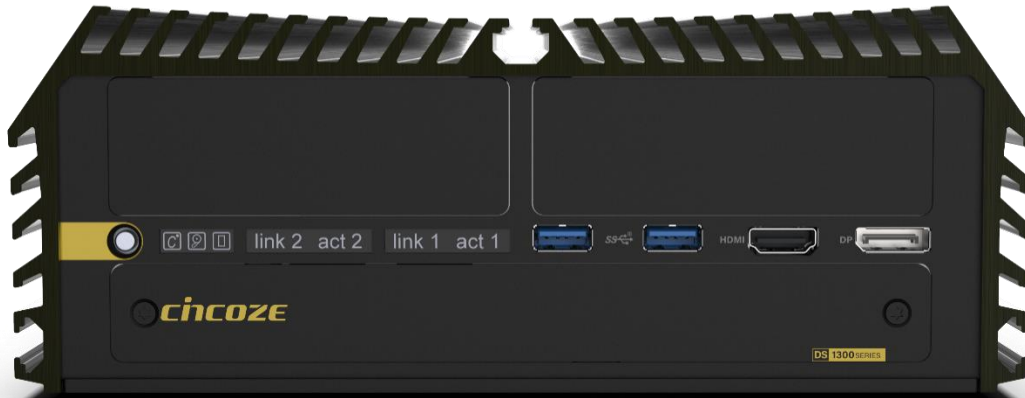

Front



Rear

DS-1301



Front



Rear

DS-1302



Front



Rear

1.4 Key Features

- 10-core 10th-gen Intel® Xeon® and Core™ i9/i7/i5/i3 CPU (max 80 W TDP)
- 2x GbE LAN and optional 2x 10GbE LAN
- 2x 2.5" SATA storage, 3x mSATA sockets, 1x M.2 key M for NVMe SSD
- 2x PCI/PCIe expansion slots
- 3x full-size Mini PCIe sockets, 2x SIM card slots
- Optional CMI modules for I/O expansion
- Optional CFM modules for ignition sensing & PoE
- Wide operating temperature -40°C to 70°C
- MIL-STD-810G military standard and EN50155 (EN 50121-3-2 only)

1.5 Hardware Specification

System

Processor	<p>Intel® Xeon® Series Processor (80W / 35W):</p> <ul style="list-style-type: none"> • Intel® Xeon® W-1270E 8 Cores Up to 4.8 GHz, TDP 80W • Intel® Xeon® W-1250E 6 Cores Up to 4.7 GHz, TDP 80W • Intel® Xeon® W-1290TE 10 Cores Up to 4.5 GHz, TDP 35W • Intel® Xeon® W-1270TE 8 Cores Up to 4.4 GHz, TDP 35W • Intel® Xeon® W-1250TE 6 Cores Up to 3.8 GHz, TDP 35W <p>Intel® Core® Series Processor (65W / 35W):</p> <ul style="list-style-type: none"> • Intel® Core™ i9-10900E 10 Cores Up to 4.7 GHz, TDP 65W • Intel® Core™ i7-10700E 8 Cores Up to 4.5 GHz, TDP 65W • Intel® Core™ i5-10500E 6 Cores Up to 4.2 GHz, TDP 65W • Intel® Core™ i3-10100E 4 Cores Up to 3.8 GHz, TDP 65W • Intel® Core™ i9-10900TE 10 Cores Up to 4.5 GHz, TDP 35W • Intel® Core™ i7-10700TE 8 Cores Up to 4.5 GHz, TDP 35W • Intel® Core™ i5-10500TE 6 Cores Up to 3.7 GHz, TDP 35W • Intel® Core™ i3-10100TE 4 Cores Up to 3.6 GHz, TDP 35W
Chipset	<ul style="list-style-type: none"> • Intel® W480E Chipset
Memory	<ul style="list-style-type: none"> • 2x DDR4 SO-DIMM Socket, Support Up to 64GB (Un-buffered and non-ECC) • Xeon / i9 / i7 Processor Supports Up to 2933MHz • i5 / i3 Processor Supports Up to 2666 MHz
BIOS	<ul style="list-style-type: none"> • AMI BIOS
Graphics	
Graphics Engine	<ul style="list-style-type: none"> • Integrated Intel® UHD-630 Graphics
Maximum Display Output	<ul style="list-style-type: none"> • Supports Triple Independent Display
HDMI	<ul style="list-style-type: none"> • 1x HDMI Connector (4096 x 2160@30Hz)
DP	<ul style="list-style-type: none"> • 2x DisplayPort Connector (4096 x 2340@60Hz)
VGA	<ul style="list-style-type: none"> • 1x VGA Connector (1920 x 1200 @60Hz)
Audio	
Audio Codec	<ul style="list-style-type: none"> • Realtek® ALC888, High Definition Audio
Line-out	<ul style="list-style-type: none"> • 1x Line-out, Phone Jack 3.5mm
Mic-in	<ul style="list-style-type: none"> • 1x Mic-in, Phone Jack 3.5mm
I/O	

LAN	<ul style="list-style-type: none"> • 2x GbE LAN, RJ45 - GbE1: Intel® I219-LM - GbE2: Intel® I210
COM	<ul style="list-style-type: none"> • 2x RS-232/422/485 with Auto Flow Control (Supports 5V/12V), DB9
USB	<ul style="list-style-type: none"> • 2x 10Gbps USB 3.2 Gen2, Type A • 4x 5Gbps USB 3.2 Gen1, Type A • 2x 480Mbps USB 2.0, Type A
PS/2	<ul style="list-style-type: none"> • 1x PS/2, 6 Pin Mini-DIN Female Connector
Storage	
SSD/HDD	<ul style="list-style-type: none"> • 1x 2.5" Front Accessible SATA HDD/SSD Bay (SATA3.0) • 1x 2.5" Internal SATA HDD/SSD Bay (SATA3.0)
mSATA	<ul style="list-style-type: none"> • 3x mSATA Socket (SATA 3.0, shared by Mini-PCIe socket)
M.2 SSD	<ul style="list-style-type: none"> • 1x M.2 Key M Type 2280 Socket, Support PCIe x4 NVMe SSD or SATA SSD (SATA3.0)
RAID	<ul style="list-style-type: none"> • Support RAID 0/1/5/10
Expansion	
PCI Express	<ul style="list-style-type: none"> • 1 x PCI/PCIe Expansion Slot with Optional Riser Card (DS-1301) • 2x PCI/PCIe Expansion Slot with Optional Riser Card (DS-1302) * Supports maximum dimensions of add-on card (L x H): 235 x 124 mm
Mini PCI Express	<ul style="list-style-type: none"> • 3x Full-size Mini-PCIe Socket
SIM Socket	<ul style="list-style-type: none"> • 2x SIM Socket
CMI (Combined Multiple I/O) Interface	<ul style="list-style-type: none"> • 2x High Speed CMI Interface for optional CMI Module Expansion • 2x Low Speed CMI Interface for optional CMI Module Expansion
CFM (Control Function Module) Interface	<ul style="list-style-type: none"> • 1x CFM IGN Interface for optional CFM-IGN Module Expansion
Other Function	
External FAN Connector	<ul style="list-style-type: none"> • 1x External FAN Connector, 4-pin Terminal Block (Support Smart Fan by BIOS)
Power Ignition Sensing	<ul style="list-style-type: none"> • Support Power Ignition Sensing Function with Delay Time Management and Selectable 12V/24V (With Optional CFM Module)
Clear CMOS Switch	<ul style="list-style-type: none"> • 1x Clear CMOS Switch
Reset Button	<ul style="list-style-type: none"> • 1x Reset Button

Instant Reboot	<ul style="list-style-type: none"> • Support 0.2sec Instant Reboot Technology
Watchdog Timer	<ul style="list-style-type: none"> • Software Programmable Supports 256 Levels System Reset
Power	
Power Button	<ul style="list-style-type: none"> • 1x ATX Power On/Off Button
Power Mode Switch	<ul style="list-style-type: none"> • 1x AT/ATX Mode Switch
Power Input	<ul style="list-style-type: none"> • 9 - 48VDC, 3-pin Terminal Block
Remote Power On/Off	<ul style="list-style-type: none"> • 1x Remote Power On/Off, 2-pin Terminal Block
Remote Power LED	<ul style="list-style-type: none"> • 1x Remote Power LED, 2-pin Terminal Block
Total Power Budget	<ul style="list-style-type: none"> • 180W
Physical	
Dimension (W x D x H)	<ul style="list-style-type: none"> • 227 x 261 x 88 mm (DS-1300) • 227 x 261 x 108 mm (DS-1301) • 227 x 261 x 128 mm (DS-1302)
Weight Information	<ul style="list-style-type: none"> • 4.3 KG (DS-1300) • 4.92 KG (DS-1301) • 5.14 KG (DS-1302)
Mechanical Construction	<ul style="list-style-type: none"> • Extruded Aluminum with Heavy Duty Metal
Mounting	<ul style="list-style-type: none"> • Wall Mount
Physical Design	<ul style="list-style-type: none"> • Fanless Design • Cableless Design • Jumper-less Design • Unibody Design
Reliability & Protection	
Reverse Power Input Protection	<ul style="list-style-type: none"> • Yes
Over Voltage Protection	<ul style="list-style-type: none"> • Protection Range: 51-58V • Protection Type: shut down operating voltage, re-power on at the present level to recover
Over Current Protection	<ul style="list-style-type: none"> • 15A
CMOS Battery Backup	<ul style="list-style-type: none"> • SuperCap Integrated for CMOS Battery Maintenance-free Operation
MTBF	<ul style="list-style-type: none"> • MTBF: 371,393 hours - Database: Telcordia SR-332 Issue3, Method 1, Case 3

Environment	
Operating Temperature	<ul style="list-style-type: none"> • 35W TDP Processor: -40°C to 70°C • 58W – 65W TDP Processor: -40°C to 50°C (With External Fan Kit) • 80W TDP Processor: -40°C to 40°C (With External Fan Kit) * PassMark BurnInTest: 100% CPU, 2D/3D Graphics (without thermal throttling) * With extended temperature peripherals; Ambient with air flow * According to IEC60068-2-1, IEC60068-2-2, IEC60068-2-14
Storage Temperature	<ul style="list-style-type: none"> • -40°C to 85°C
Relative Humidity	<ul style="list-style-type: none"> • 95%RH @ 70°C (non-Condensing)
Ingress Protection	<ul style="list-style-type: none"> • Ingress Protection IP30 Compliant * According to IEC60529
Shock	<ul style="list-style-type: none"> • MIL-STD-810G
Vibration	<ul style="list-style-type: none"> • MIL-STD-810G
EMC	<ul style="list-style-type: none"> • CE, UKCA, FCC, ICES-003 Class A • EN 50155 (EN50121-3-2 Only)
Safety	<ul style="list-style-type: none"> • UL, cUL, CB, IEC, EN 62368-1
Operating System	
Windows	<ul style="list-style-type: none"> • Windows® 10
Linux	<ul style="list-style-type: none"> • Supports by project

** Product Specifications and features are for reference only and are subject to change without prior notice. For more information, please refer to the latest product datasheet from Cincoze's website.*

1.6 System I/O

1.6.1 Front

ATX Power On/Off

Used to power-on or power-off the system

Temperature LED

Indicates the temperature of the system

HDD LED

Indicates the status of the hard drive

GPIO LED

Indicates the status of the GPIO

Ethernet LED

Indicates the status of the LAN ports

Universal I/O Bracket

Used to customized I/O output

USB 3.2 Gen2

Used to connect USB 3.2 Gen2/3.2 Gen1/3.0/2.0/1.1 device

HDMI

Used to connect the system with HDMI monitor

DisplayPort

Used to connect the system with DisplayPort monitor

AT/ATX Mode Switch

Used to select AT or ATX power mode

SIM Socket

Used to inserts a SIM card

Removable HDD Bay

Used to inserts a 2.5" HDD

CMOS Battery

Used to inserts a CMOS battery

IGN Setting Switch

Used to set up IGN function

Reset Button

Used to reset the system

DS-1300

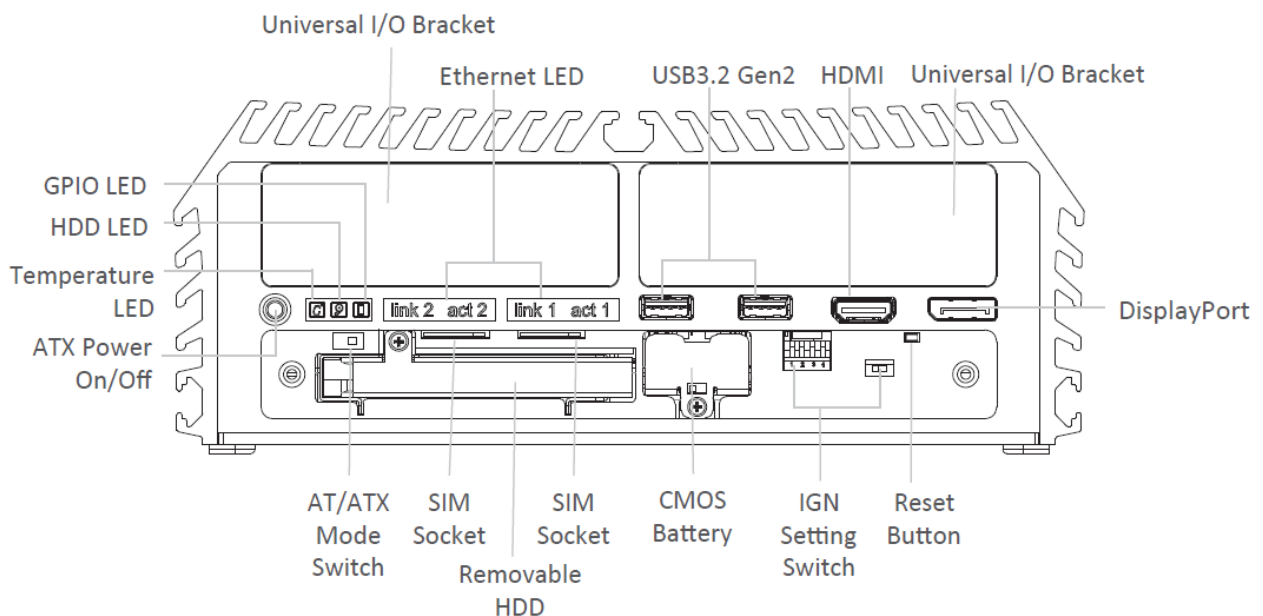

DS-1301

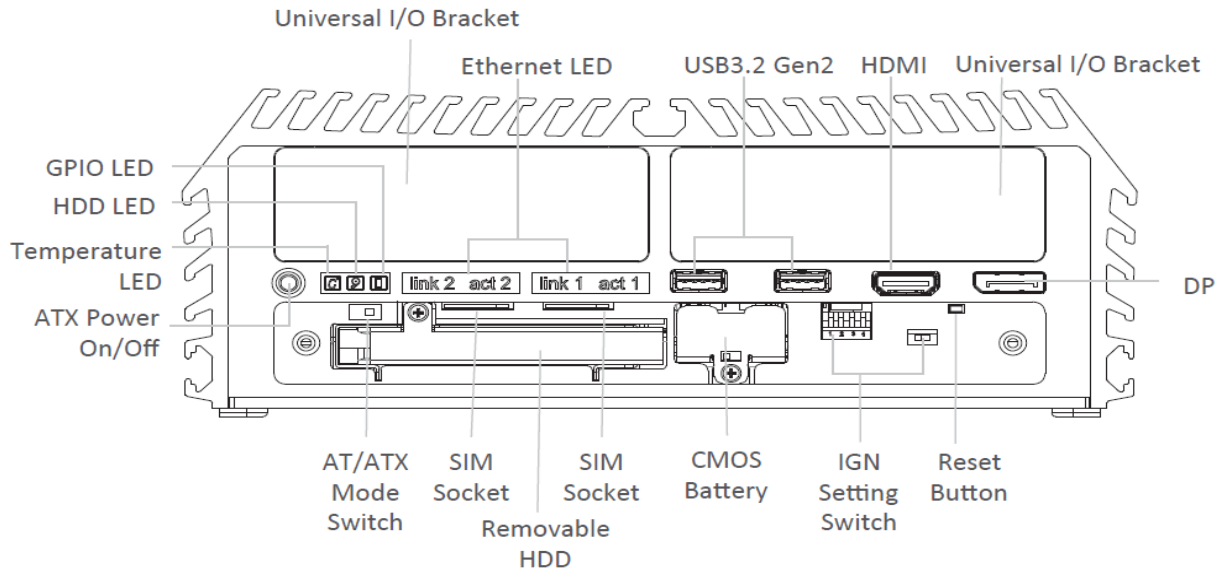

DS-1302

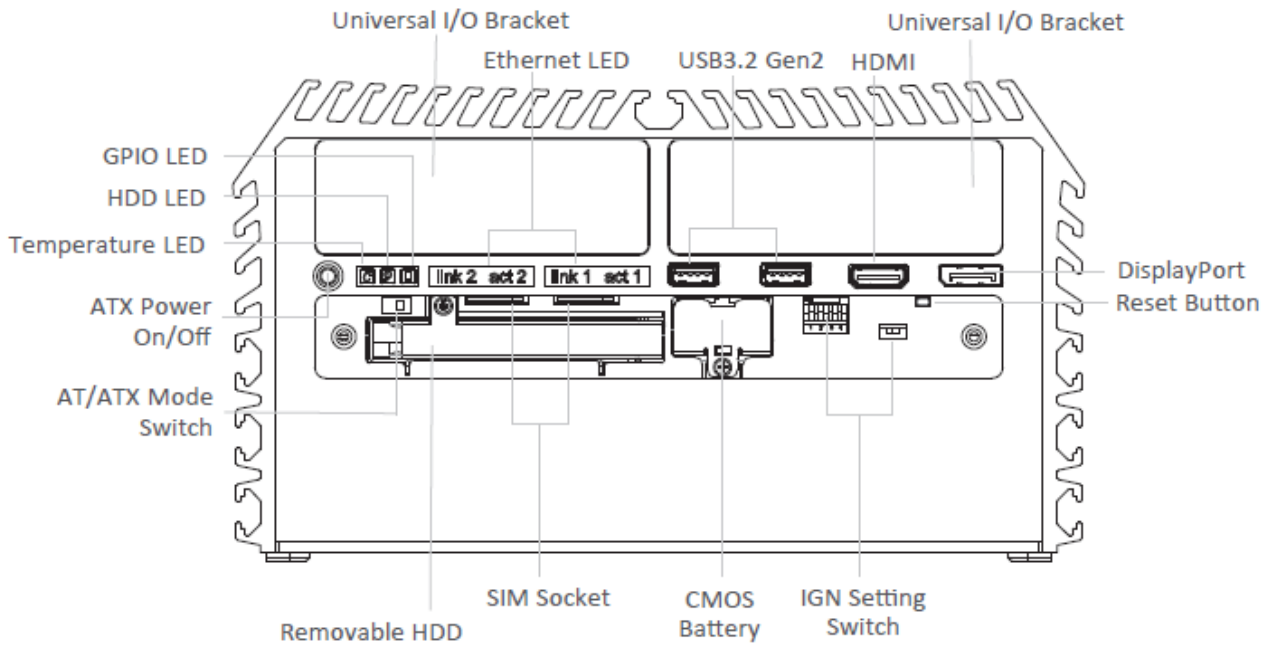

1.6.2 Rear

DC IN

Used to plug a DC power input with terminal block

Antenna

Used to connect an antenna for optional wireless module

External Fan Power

Used to plug an external fan with terminal block

VGA

Used to connect a monitor with VGA interface

DisplayPort

Used to connect the system with DisplayPort monitor

PS/2 Port

Used to connect the PS/2 device

USB 2.0

Used to connect USB 2.0/1.1 device

LAN1, LAN2

Used to connect to local area network

USB 3.2 Gen1

Used to connect USB 3.2 Gen1/3.0/2.0/1.1 device

COM1, COM2

Used to connect to RS-232/422/485 serial devices

Line-Out

Used to connect a speaker

Mic-In

Used to connect a microphone

Remote Power LED

A terminal block used to connect to remote power on/off LED

Remote Power On/Off

A terminal block used to connect to remote power on/off switch

Universal I/O Bracket

Used to customized I/O output

DS-1300

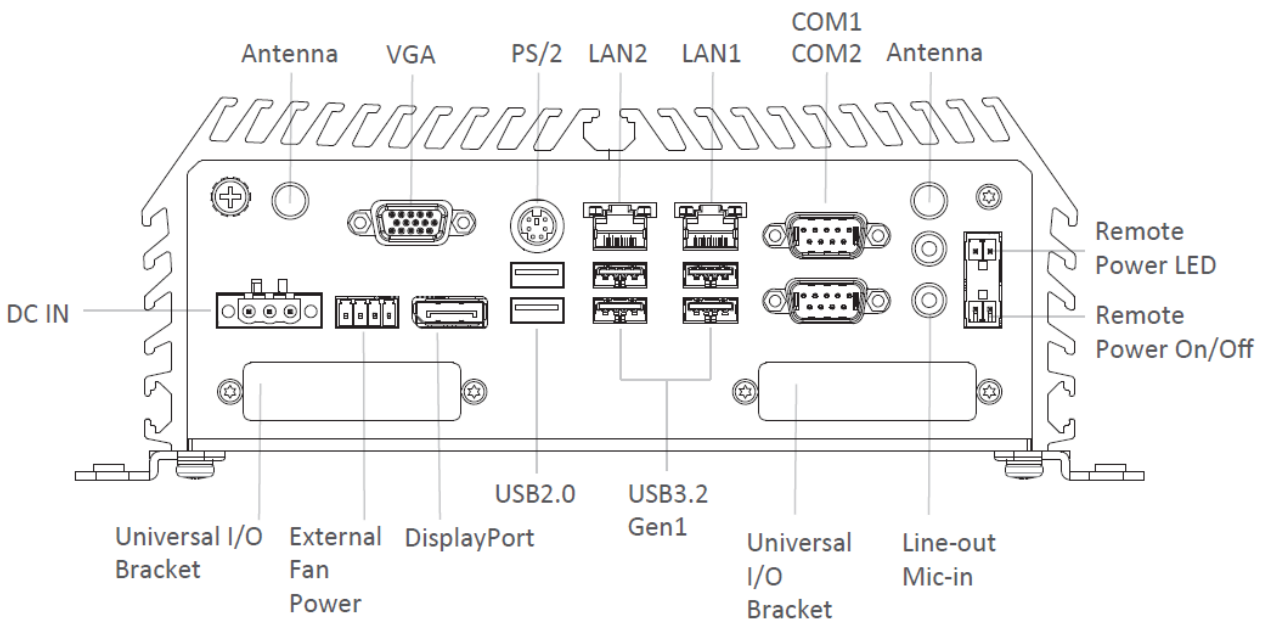

DS-1301

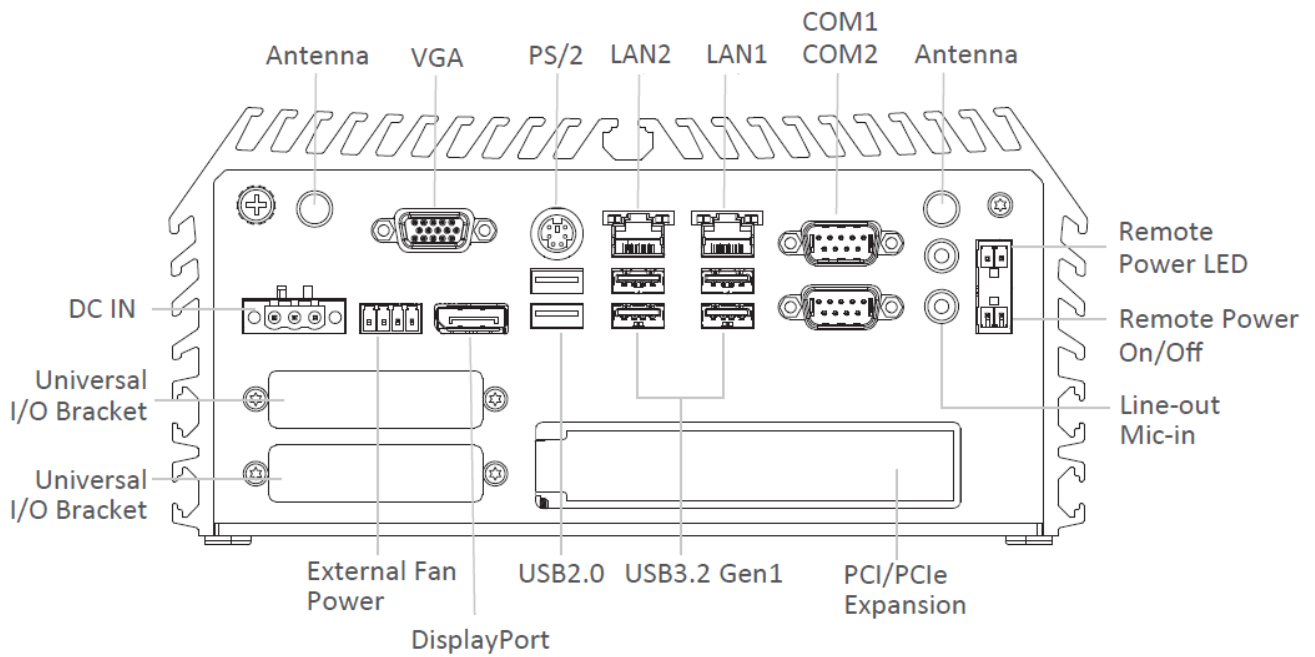

DS-1302

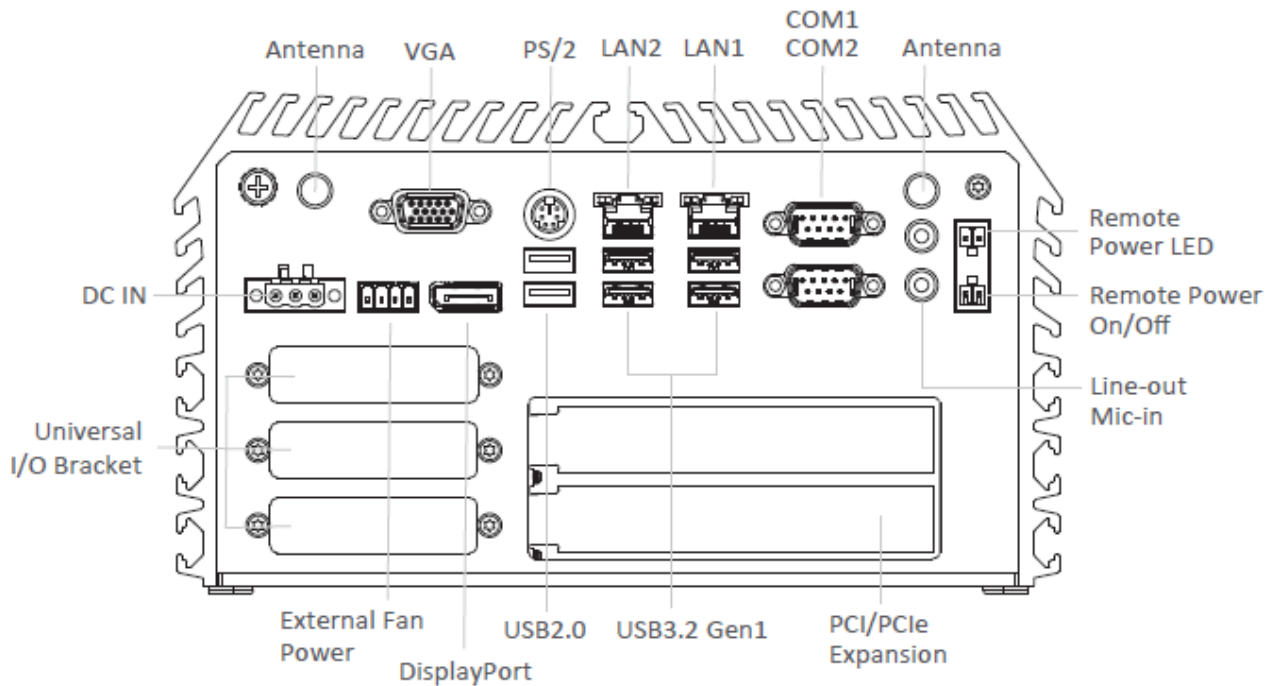

1.7 Mechanical Dimension

DS-1300

Unit: mm

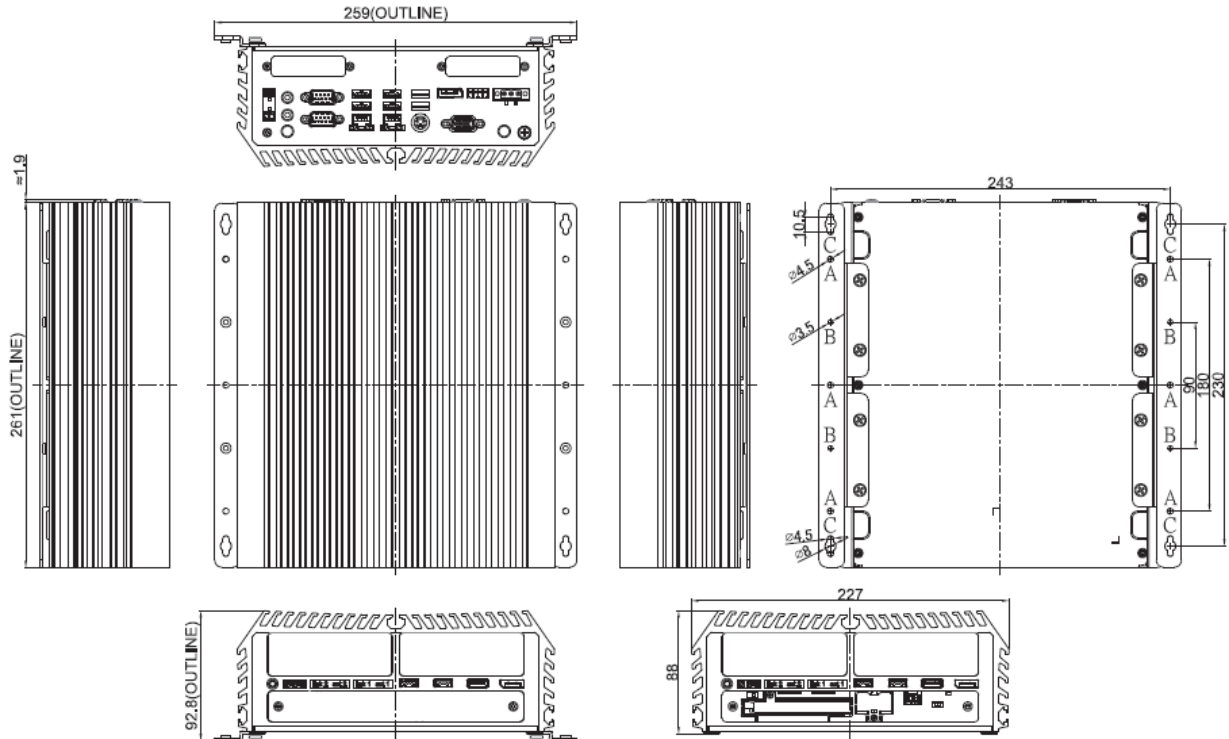

DS-1301

Unit: mm

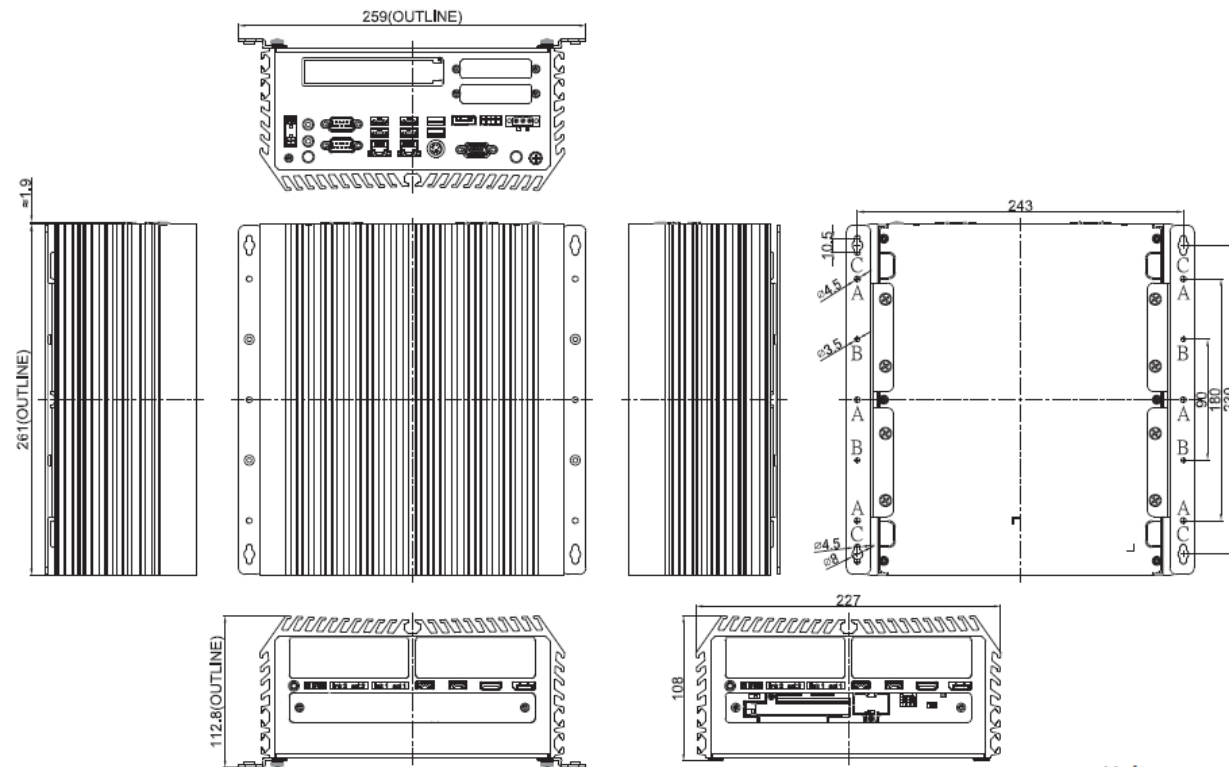

DS-1302

Unit: mm

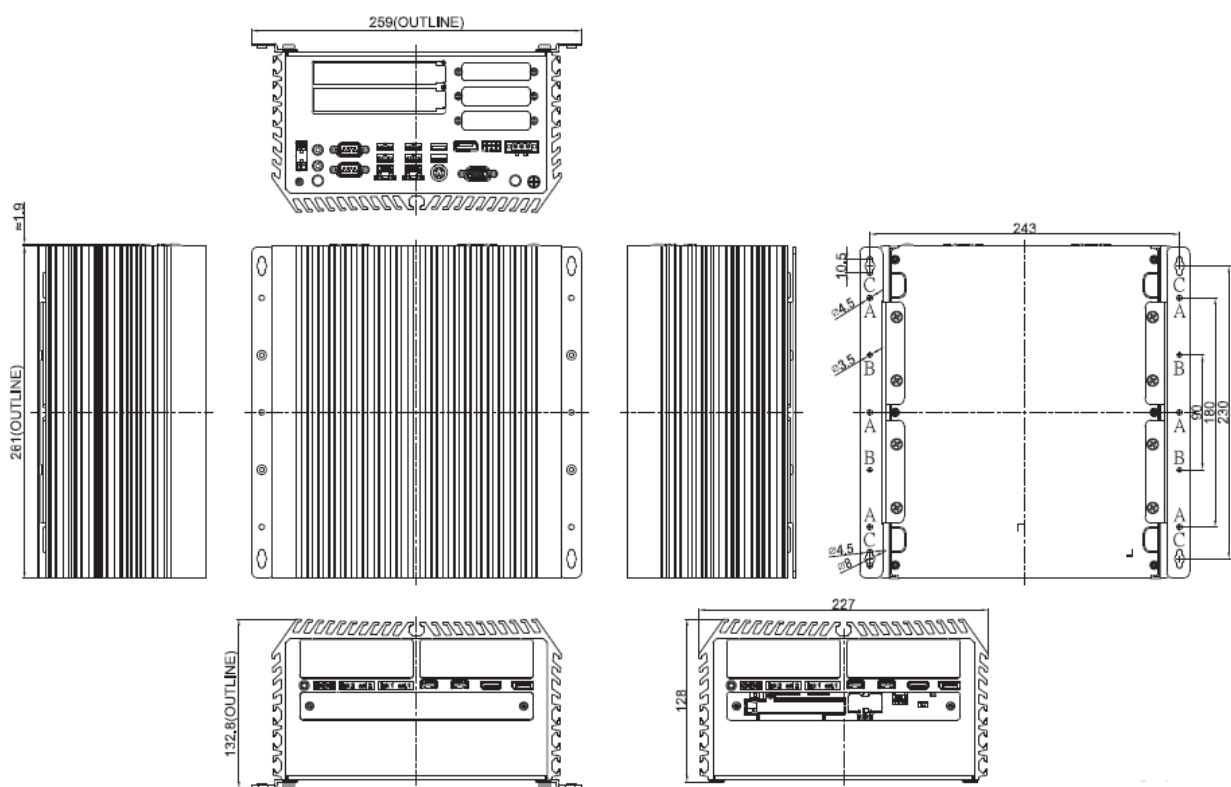



Chapter 2

Switches & Connectors

2.1 Location of Switches and Connectors

2.1.1 Top View

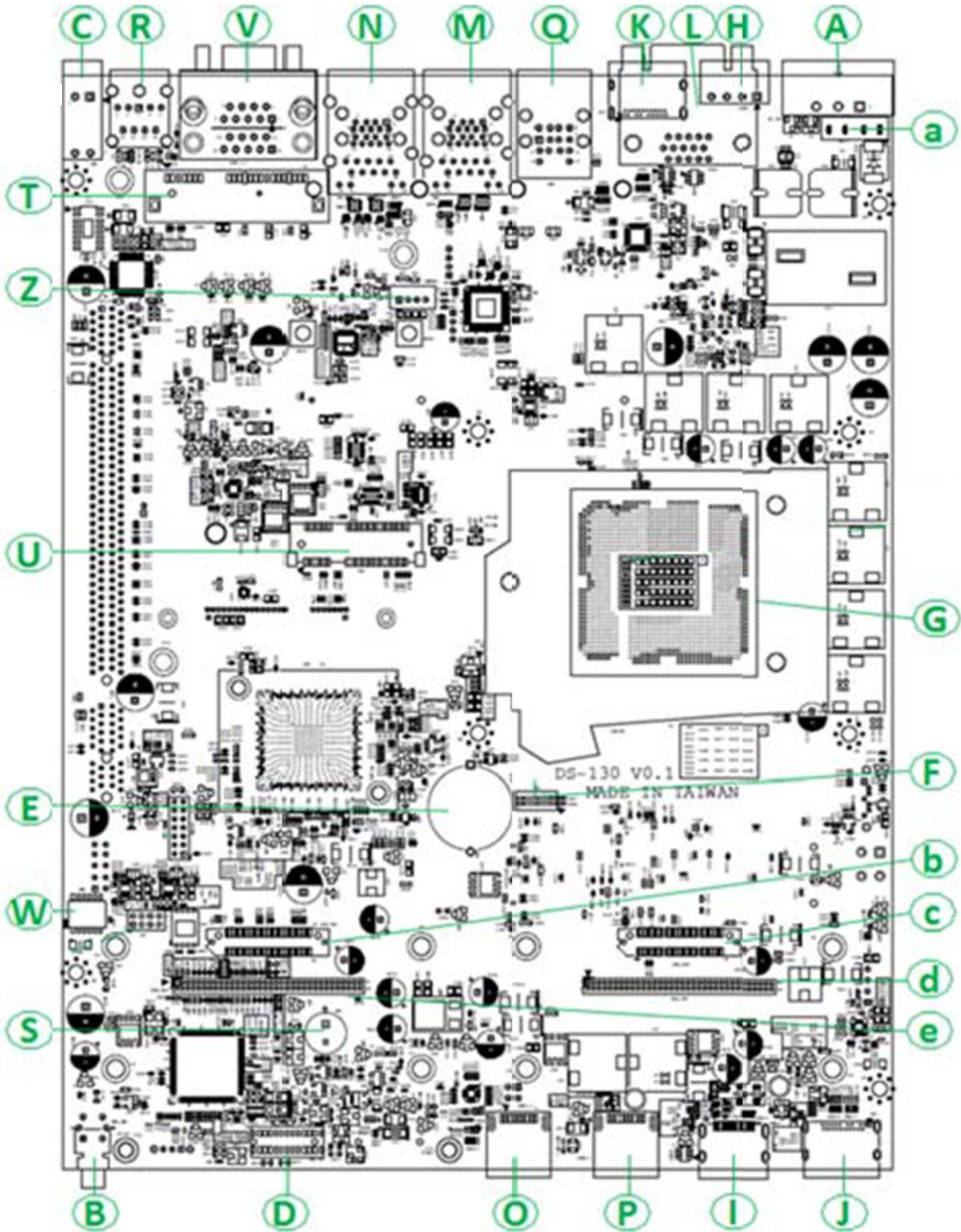

2.1.2 Bottom View

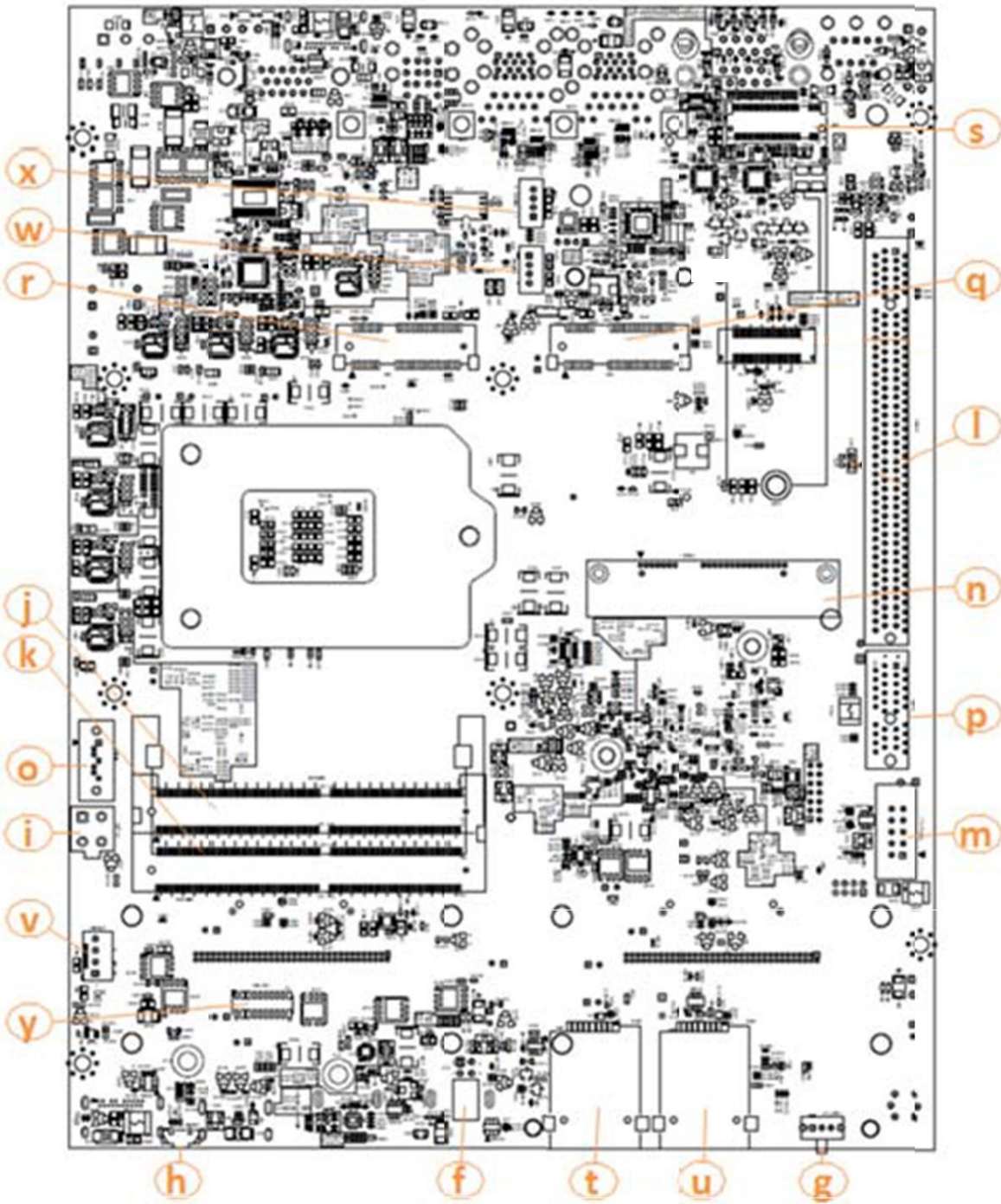

2.2 Switches and Connectors Definition

List of Switch & Connector

Location	Connector	Definition
Ⓑ	PWR_SW1	Power button with power on LED
Ⓓ	LED_PH1	LED board connector
ⓅⓄ	USB3_1, USB3_2	USB3.2 Gen2 port connector
Ⓘ	HDMI1	HDMI connector
ⓃⓀ	DP1, DP2	Display Port (DP++) connector
Ⓢ	BZ1	Buzzer
Ⓟ	BTB_FH2	CM BTB 50 pins Slot, support PCIE 1x4 or 4x1 4LAN/POE
Ⓒ	BTB_FH4	CM BTB 50 pins Slot, support PCIE 1x2 or 2x1 4LAN/POE
ⓔⓓ	BTB_FH1, BTB_FH3	CM BTB 68 pins Connector, support COM3-COM6/16 Bits DIO.
Ⓦ	SW1	SATA DOM/ COM1 and COM2 Power Select
Ⓔ	GDC1	Super CAP for CMOS Backup
Ⓕ	SW2	Super CAP switch
Ⓖ	U1	CPU Socket LGA1200
Ⓤ	CN5	Mini PCI-Express Socket (Support mPCIE/ mSATA / USB3 + SIM module)
ⓏⓍⓌⓋ	POWER1, POWER2, POWER3, POWER4	+5V/+12V power output connector
Ⓣ	SATA1	22 PINs SATA Connector
ⓐ	FS_1	DC input power fuse 15A/58V
Ⓒ	CN7	Remote Power On/Off + Remote Power LED connector
Ⓡ	AUDIO1	2 IN 1 Audio Phone Jack for Headphone line out & MIC phone in
Ⓥ	COM_1_1	Dual COM connector (COM1-2), support RS232/RS422/RS485
ⓃⓂ	CN1, CN2	Dual USB3.2 Gen1 + GLAN RJ45 Connector
Ⓚ	CN6	Dual USB2.0 + PS2 Connector
Ⓛ	VGA1	VGA Connector (DB15)
Ⓜ	FAN1	CPU Smart FAN Connector
Ⓐ	DC_IN2	3 PINs DC 9-48V power input with power ignition connector
ⓗ	RESET1	Reset button
Ⓕ	JP2	RTC battery board connector
ⓊⓉ	SIM1, SIM2	SIM card socket A and B

ⓐ	AT_ATX	AT/ATX power mode switch (default AT mode)
ⓑ	IGN_PH1	IGN control board connector
ⓒ	DC_IN1	4 PINs DC 9-48V power input connector
ⓓ	SATA3	7 PINs SATA/SATA DOM Connector
ⓔⓕ	SODIMM1, SODIMM2	DDR4 SO-DIMM
ⓖ	USB2_13_1	USB2.0 BOX Header (2 Ports)
ⓗ	PCIE1	PCIE x1 Slot
ⓘ	SATA2	22 PINs SATA Connector
ⓙ	PCIE2	PEG/PCIE x16 Slot
ⓚⓛ	CN3, CN4	Mini PCI-Express Socket (Support mPCIe/ mSATA / USB3 module)
ⓜ	CN8	M.2 Key M Socket (Support AHCI or NVMe PCIe / SATA Storage)

2.3 Definition of Switches

PWR_SW1: Power button with power on LED

Switch	Definition
Push	Power System



LED Type	LED Status	Status
Power LED	Blue	Power off (S4/S5)
	Green	Power on (S0)
	Blinking Blue & Green	Stand by (S3)

SW1: SATA DOM / COM1 / COM2 Power Select

Location	Function		DIP1	DIP2
SW1	SATA DOM	Disable	N/A	ON (Default)
		Enable		OFF
Location	Function		DIP3	DIP4
SW1	COM1	0V(RI)	ON (Default)	ON (Default)
		5V	ON	OFF
		12V	OFF	OFF
Location	Function		DIP5	DIP6
SW1	COM2	0V(RI)	ON (Default)	ON (Default)
		5V	ON	OFF
		12V	OFF	OFF

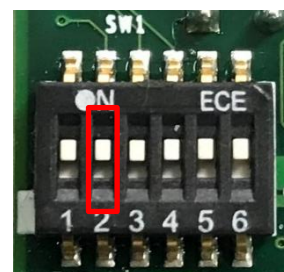

ON
OFF

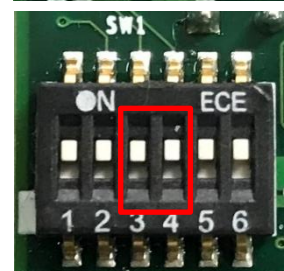

ON
OFF

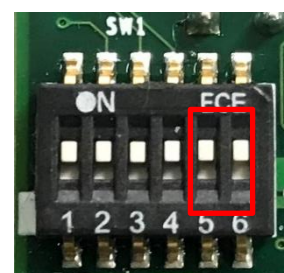

ON
OFF

SW2: Super CAP Switch

Location	Function		DIP1	DIP2
SW2	Super CAP	Enabled	ON (Default)	ON (Default)
		Disabled	OFF	

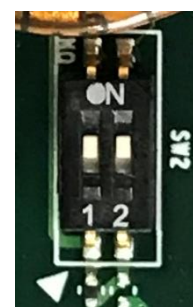

ON
OFF

RESET1: Reset Button

Switch	Definition
Push	Reset System



AT_ATX: AT / ATX Power Mode Switch

Switch	Definition
Left	AT Power Mode
Right	ATX Power Mode (Default)



CLR_CMOS1: Clear BIOS Switch

Pin	Definition
1-2 (Left)	Normal Status (Default)
2-3 (Right)	Clear BIOS



WARNING
(AVERTIR)

After performing Clear CMOS, the system will take several minutes to start. This is normal. During this process, the system will POST three times, and the system's Power LED will alternate between green and blue lights.

(Après avoir effectué Clear CMOS, le système prendra plusieurs minutes pour démarrer. Cela est normal. Pendant ce processus, le système effectuera trois fois le POST, et la LED d'alimentation du système alternera entre les lumières verte et bleue.)

2.4 Definition of Connectors

CN5 : Mini PCI-Express Socket (Support mPCIE/ mSATA / USB3 + SIM module)

PIN	Definition	PIN	Definition
1	WAKE#	27	GND
2	3.3Vaux	28	+1.5V
3	N/A	29	GND
4	GND	30	SMB_CLK
5	N/A	31	PETn0 / SATA_TXN
6	1.5V	32	SMB_DATA
7	UIM_RESET_B	33	PETp0 / SATA_TXP
8	UIM_PWR_A	34	GND
9	GND	35	GND
10	UIM_DATA_A	36	USB_D-
11	REFCLK-	37	GND
12	UIM_CLK_A	38	USB_D+
13	REFCLK+ / UIM_PWR_B	39	+3.3Vaux
14	UIM_RESET_A	40	GND
15	GND	41	+3.3Vaux
16	UIM_VPP_A	42	N/A
17	UIM_IC_DM / (UIM_CLK_B)	43	GND
18	GND	44	N/A
19	UIM_IC_DP / (UIM_DATA_B)	45	CL_CLK
20	W_DISABLE1#	46	N/A
21	GND	47	CL_DATA
22	PERST#	48	+1.5V
23	PERn0 / SATA_RXP	49	CL_RST
24	+3.3Vaux	50	GND
25	PERp0 / SATA_RXN	51	N/A
26	GND	52	+3.3Vaux

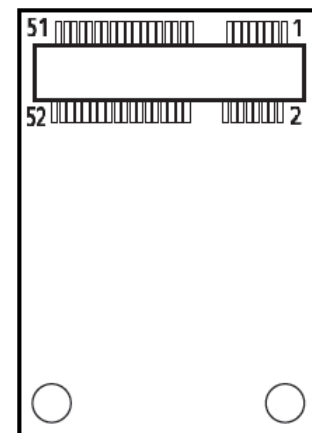

CN3/CN4 : Mini PCI-Express Socket (Support mPCIE/ mSATA / USB3)

PIN	Definition	PIN	Definition
1	WAKE#	27	GND
2	3.3Vaux	28	+1.5V
3	N/A	29	GND
4	GND	30	SMB_CLK
5	N/A	31	PETn0 / SATA_TXN
6	1.5V	32	SMB_DATA
7	N/A	33	PETp0 / SATA_TXP
8	N/A	34	GND
9	GND	35	GND
10	N/A	36	USB_D-
11	REFCLK-	37	GND
12	N/A	38	USB_D+
13	REFCLK+	39	+3.3Vaux
14	N/A	40	GND
15	GND	41	+3.3Vaux
16	N/A	42	N/A
17	N/A	43	GND
18	GND	44	N/A
19	N/A	45	N/A
20	W_DISABLE1#	46	N/A
21	GND	47	N/A
22	PERST#	48	+1.5V
23	PERn0 / SATA_RXP	49	N/A
24	+3.3Vaux	50	GND
25	PERp0 / SATA_RXN	51	N/A
26	GND	52	+3.3Vaux

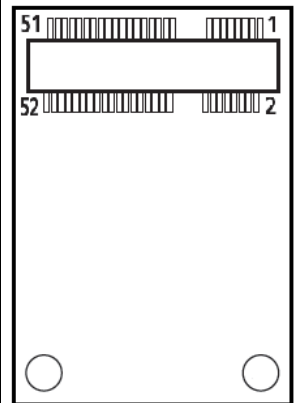

CN8 : M.2 Key M Socket (Support AHCI or NVMe PCIe / SATA Storage)

(Pin 59-66 are connector keys)

Pin	Definition	Pin	Definition	Pin	Definition
1	CFG3	27	GND	53	REFCLKN
2	3.3V	28	NC	54	PEWAKE*/NC
3	GND	29	PERN1	55	REFCLKP
4	3.3V	30	NC	56	NC
5	PERN3-	31	PERP1	57	GND
6	NC	32	NC	58	NC
7	PERP3	33	GND	67	NC
8	NC	34	NC	68	SUSCLK
9	GND	35	PETN1	69	PEDET/CFG1
10	DAS/DSS*	36	NC	70	3.3V
11	PETN3	37	PETP1	71	GND
12	3.3V	38	DEVSLP	72	3.3V
13	PETP3	39	GND	73	GND
14	3.3V	40	SMB_CLK	74	3.3V
15	GND	41	PERNO/SATA_B+	75	CFG2
16	3.3V	42	SMB_DATA		
17	PERN2	43	PERPO/SATA_B-		
18	3.3V	44	ALERT#		
19	PERP2	45	GND		
20	NC	46	NC		
21	CFG0	47	PETNO/SATA_A-		
22	NC	48	NC		
23	PETN2	49	PETPO/SATA_A+		
24	NC	50	PERST*/NC		
25	PETP2	51	GND		
26	NC	52	CLKREQ*/NC		

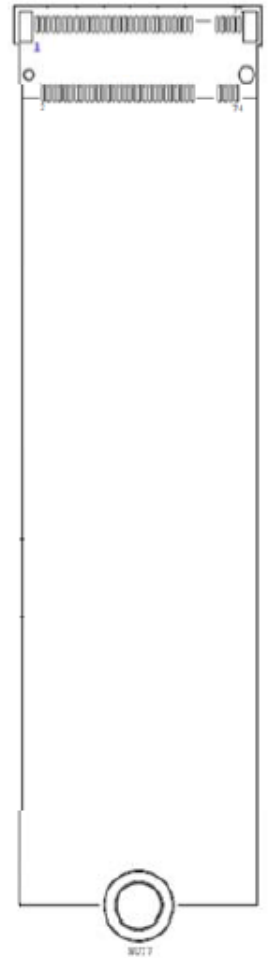

POWER1, POWER2, POWER3: +5V/+12V Power Output Connector

Connector Type: 1X4-pin Wafer, 2.0 mm pitch

Pin	Definition
1	+5V
2	GND
3	GND
4	+12V

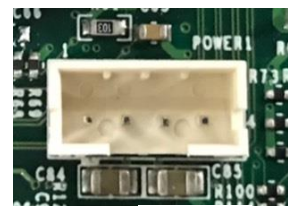

1 2 3 4

POWER4: Power Connector

Connector Type: 1X4-pin Wafer, 2.54mm pitch

Pin	Definition
1	+5V
2	GND
3	GND
4	+12V



1 2 3 4

CN7 : Remote Power On/Off + Remote Power LED Connector

Remote Power LED connector can connect an external LED indicator up to 10mA.

Connector Type: Terminal Block 2X2 4-pin, 3.5mm pitch

Pin	Definition
1	RMT_PWR_BTN_N
2	RMT_PWR_LED_A
3	GND
4	GND



2 4

1 3



WARNING (AVERTIR) Do not apply power to this connector! This port is used to connect a SWITCH!
 (Ne mettez pas sous tension ce connecteur! Ce port est utilisé pour connecter un SWITCH!)

FAN1: CPU Smart Fan Connector

Connector Type: Terminal Block 1X4 4-pin, 3.5mm pitch

Pin	Definition
1	GND
2	+12V
3	FAN_IN
4	FAN_PWR

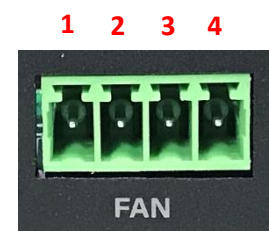

1 2 3 4

SATA3: 7 PINs SATA/SATA DOM Connector

Pin	Definition	Pin	Definition
1	GND	5	B-
2	A+	6	B+
3	A-	7	+5V
4	GND		



USB2_13_1: USB2.0 BOX Header (2 Ports)

Connector Type: Box Header, 2x5 10-pin, 2.54mm pitch

Pin	Definition	Pin	Definition
1	VBUS (+5V)	6	USB2_P1_DP
2	VBUS (+5V)	7	GND
3	USB2_PO_DN	8	GND
4	USB2_P1_DN	9	CGND
5	USB2_PO_DP	10	CGND

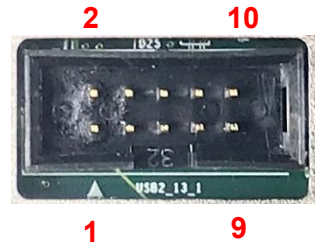

COM1 / COM2 : RS232 / RS422 / RS485 Connector

Connector Type: 9-pin D-Sub

Pin	RS232 Definition	RS422 / 485 Full Duplex Definition	RS485 Half Duplex Definition
1	DCD	TX-	DATA -
2	RXD	TX+	DATA +
3	TXD	RX+	
4	DTR	RX-	
5	GND		
6	DSR		
7	RTS		
8	CTS		
9	RI		

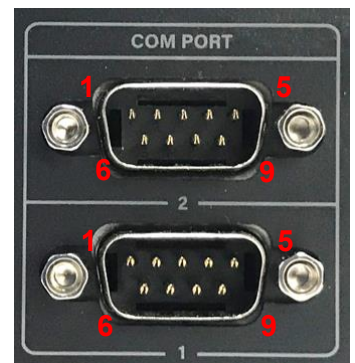

DC_IN2: 3 PINs DC 9-48V power input with power ignition connector

Connector Type: Terminal Block 1x3 3-pin, 5.0mm pitch

Pin	Definition
1	+9-48VIN
2	Ignition (IGN)
3	GND

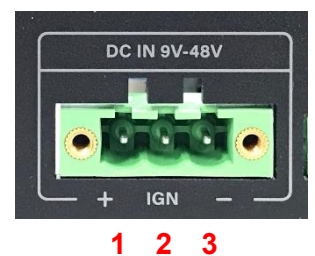



CAUTION
(ATTENTION)

Please disconnect the power source before mounting the DC power cables or connecting the DC power connector to system.

(Veuillez débrancher la source d'alimentation avant de monter les câbles d'alimentation CC ou de connecter le connecteur d'alimentation CC au système.)

DC_IN1: 4 PINs DC 9-48V Power Connector

Connector Type: 2x2 4-pin, 4.2mm pitch

Pin	Definition
1	GND
2	GND
3	+9-48VIN
4	+9-48VIN

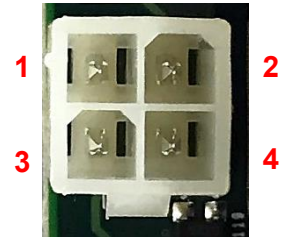

WARNING
(AVERTIR)

Before using this connector, make sure that the PIN3 & PIN4 voltage meets the power requirements of the device.

(Avant d'utiliser ce connecteur, assurez-vous que la tension PIN3 et PIN4 répond aux exigences d'alimentation de l'appareil.)

LED_PH1: LED board connector

LED type	Status	LED Color
TEMP LED	System Temp $\leq 65^{\circ}\text{C}$	Colorless
	$65^{\circ}\text{C} < \text{System Temp} \leq 70^{\circ}\text{C}$	Blue
	$70^{\circ}\text{C} < \text{System Temp} \leq 75^{\circ}\text{C}$	Red
	$75^{\circ}\text{C} < \text{System Temp}$	Blinking Red
HDD LED	Data activity	Yellow
	No activity	Off
GPIO LED	GPIO activity	Green
	No activity	Off

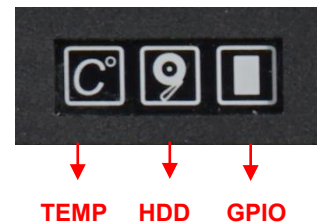

NOTE
(NOTE)



The TEMP LED is only available when IGN module is installed.

(La LED TEMP n'est disponible que lorsque le module IGN est installé.)

LAN LED Status Definition

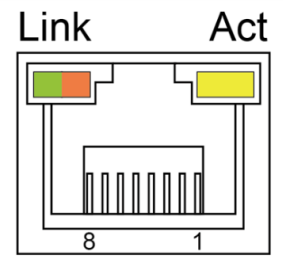
Link LED Status	Definition
Steady Green	1 Gbps Network Link
Steady Orange	100 Mbps Network Link
Off	10 Mbps Network Link
Act LED Status	Definition
Blinking Yellow	Data Activity
Steady Yellow	No Activity





Chapter 3

System Setup

This chapter takes DS-1300 as an example to demonstrate the installation of hardware components, except for chapter 3.8.

3.1 Removing Top Cover



WARNING
(AVERTIR)

To prevent electrical shock or system damage, the power must be turned off and the unit must be disconnected from all power sources before removing the top cover.

(Pour éviter tout choc électrique ou dommage au système, l'alimentation doit être coupée et l'appareil déconnecté de toutes les sources d'alimentation avant de retirer le capot supérieur.)

1. Turn over the unit to have the bottom side face up, loosen the 6 screws on the bottom cover and place them aside for later use.

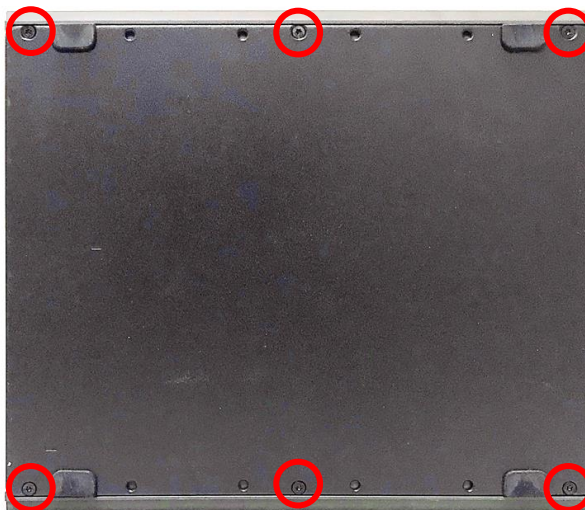

2. Remove the bottom cover from the chassis.



3. Unscrew the 2 screws at the rear bezel as indicated and place them aside for later use.



4. Loosen the 4 screws. Pull out the 4 latches as marked.

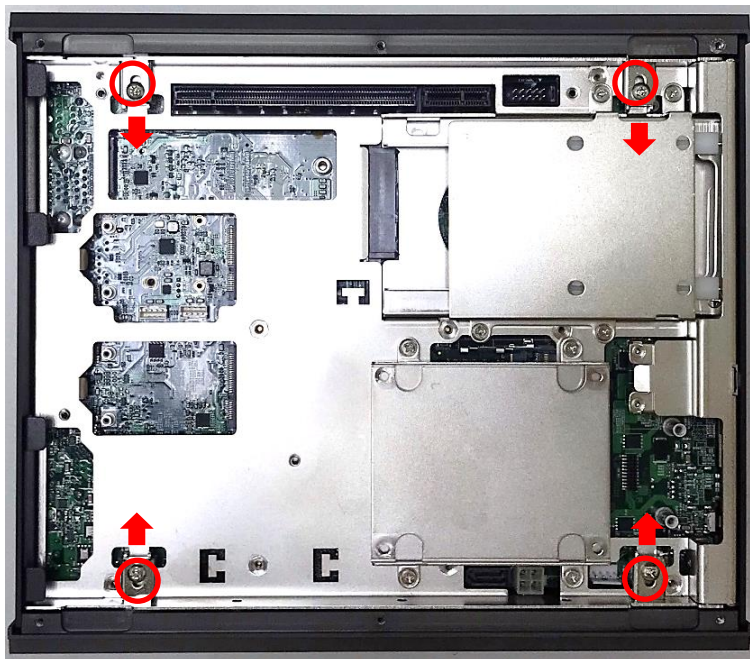

5. Lift up the unit vertically by holding the front and rear panel.

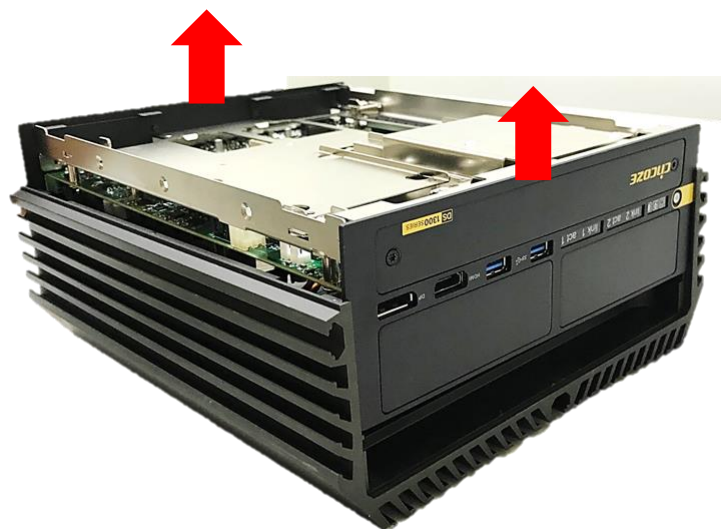

6. Turn over the body of the unit and place it gently.

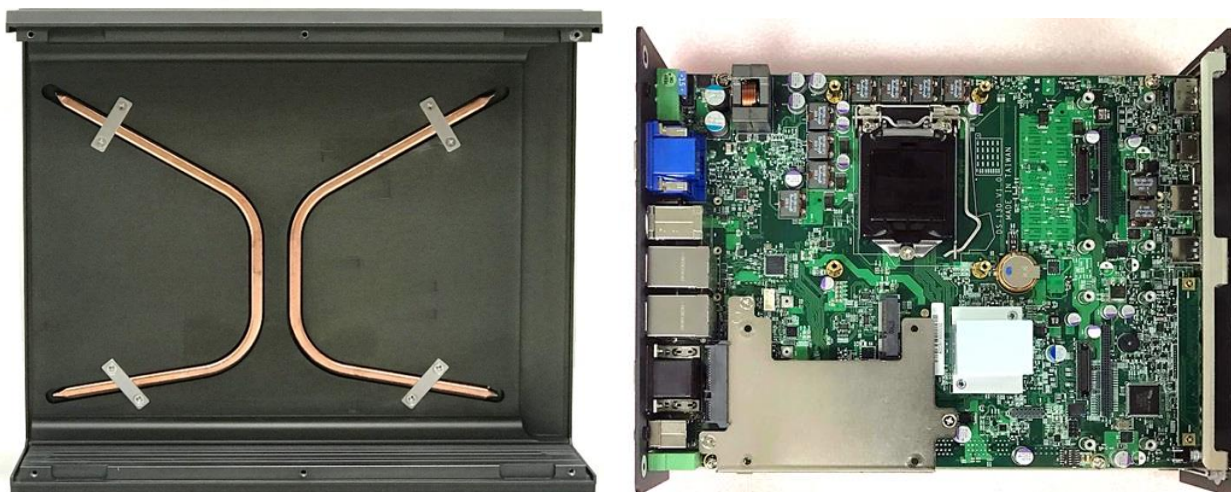

3.2 Installing CPU

1. Locate the CPU socket.

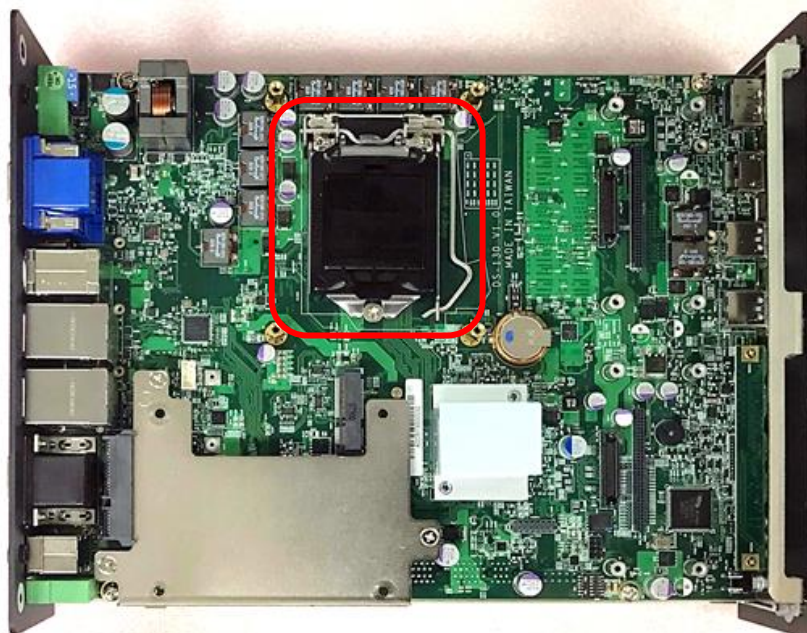

2. Pull aside and then lift up the socket lever to unlock the socket.

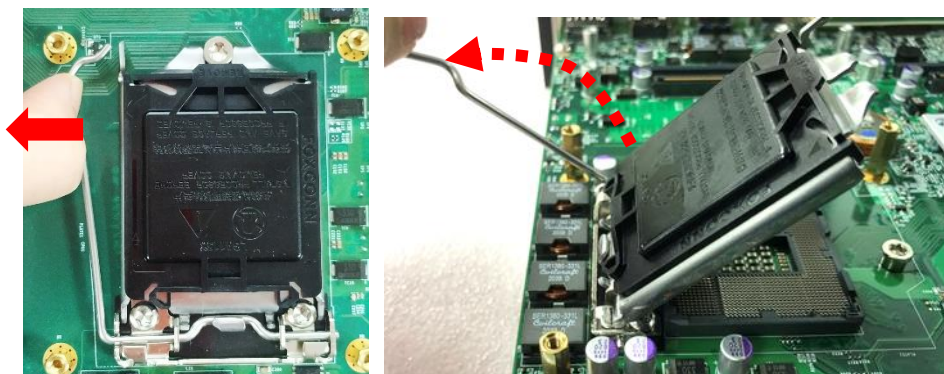

3. Align the notches on the CPU with protrusions on the socket. Hold the CPU by the edges and put on the CPU gently.

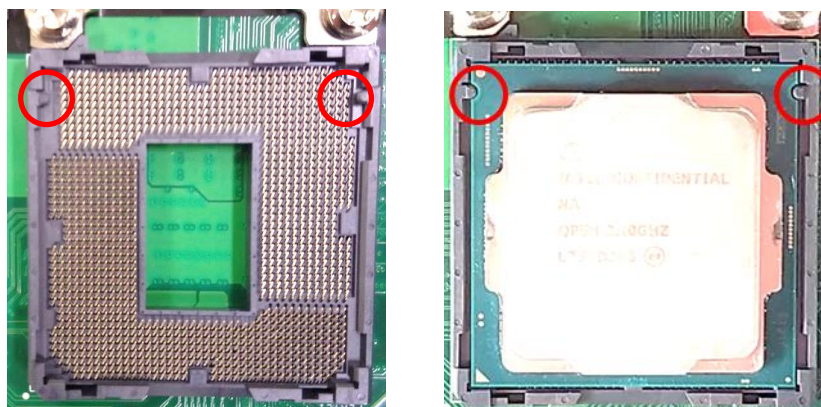

4. Press down the socket lever to lock the CPU.



5. Place the CPU heatsink on with aligning the four mounting holes of the heatsink and the nut studs and then fasten the heatsink with the provided 4 screws.

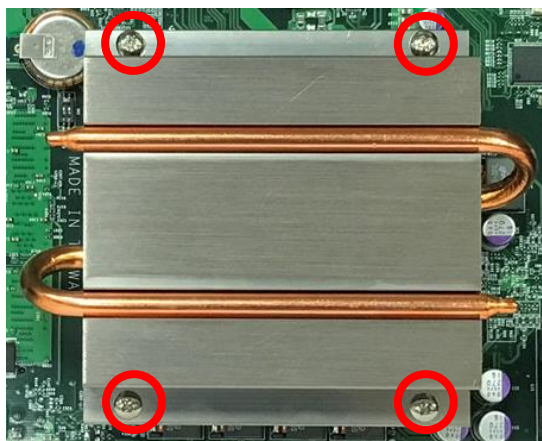

3.3 Installing SO-DIMM

1. Turn the system to the bottom side. Unscrews the 4 screws and remove the bracket.

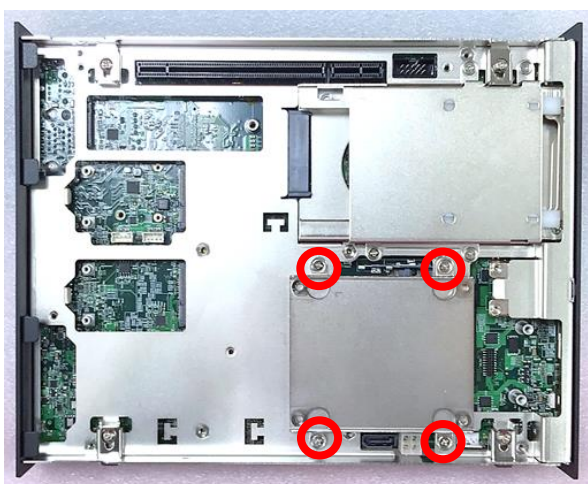

2. Locate two SO-DIMM sockets at the bottom.

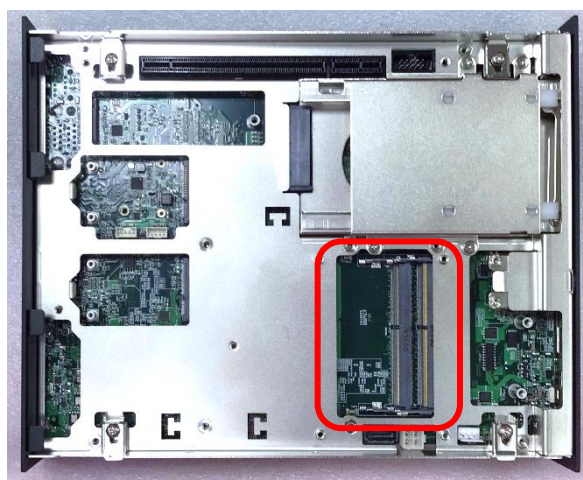

3. Insert the SO-DIMM at a 45-degree angle until its edge connector is connected to the SO-DIMM socket firmly.

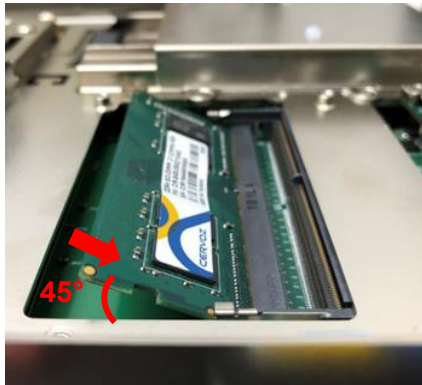

Lower socket

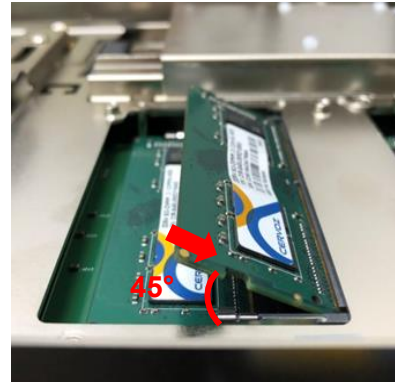

Upper socket

4. Press down the module until the retaining clips snap back in place.



Lower socket



Upper socket

5. Put the cover back and fix the cover with 4 screws.

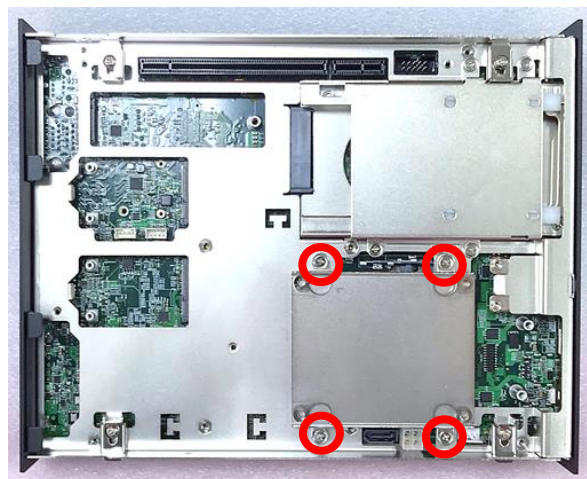

3.4 Installing Mini-PCIe Card

1. Locate the Mini PCIe socket CN5 on the top side and CN3/CN4 on the bottom side of the system.

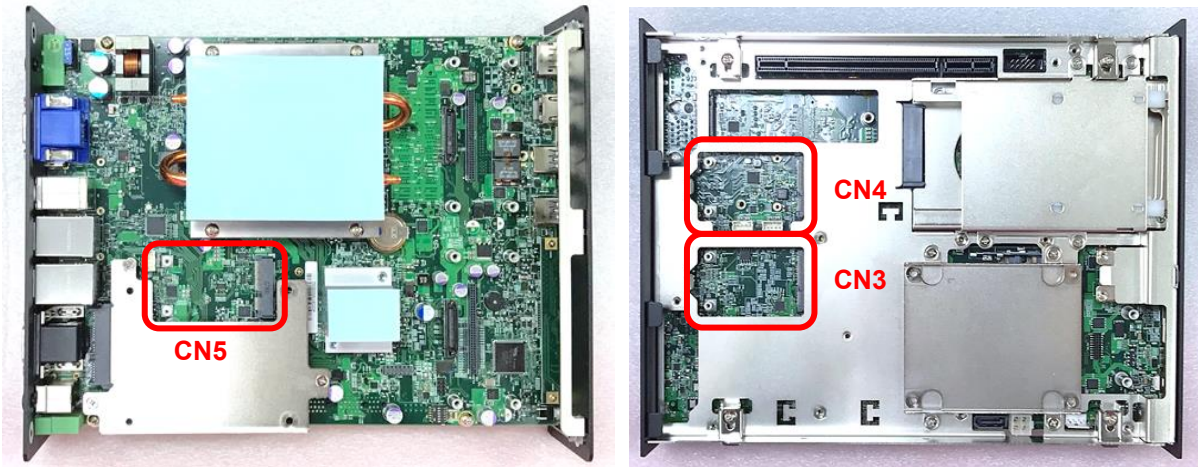

2. Use provided two screws fasten the half size module and adapter bracket together as shown in Fig (a) below.



(a) Half Size Mini-PCIe

(b) Full Size Mini-PCIe Card

3. Tilt a Mini PCIe card at a 45-degree angle and insert it to the socket until the golden finger connector of the card seated firmly.



4. Press the card down and secure it with 2 screws.



3.5 Installing M.2 M Key Card

1. Turn the system to the bottom side, and locate the M.2 M Key slot (CN8).

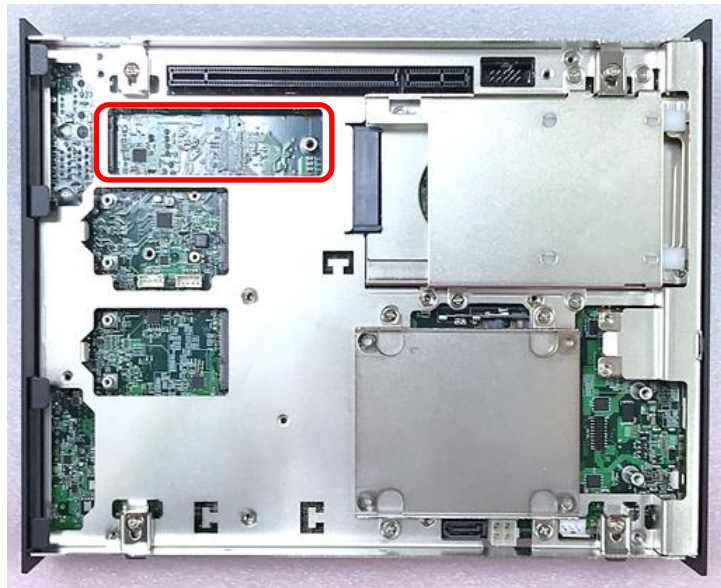

2. Tilt the M.2 M Key card at a 45-degree angle and insert it to the socket until the golden finger connector of the card seated firmly.



3. Press the card down and secure it with the screw.



3.6 Installing Antenna

1. Remove the antenna rubber cover on the rear panel.



2. Penetrate the antenna jack through the hole.



3. Put on the washer and fasten the nut of antenna jack.



4. Assemble the antenna and antenna jack together.



5. Attach the RF connector of the cable's another end onto the card.



3.7 Installing Antenna Cutout Universal Bracket (Rear)

An optional Universal Bracket (Model No. UB0331) features two antenna cutouts for wireless application. This bracket allows users to mount antennas in the designated cutouts. For Antenna installation details, refer to Chapter 3.6.

1. Loosen and remove the two screws from either the left-side or right-side bracket of the system rear panel (this example uses the left-side bracket for demonstration).

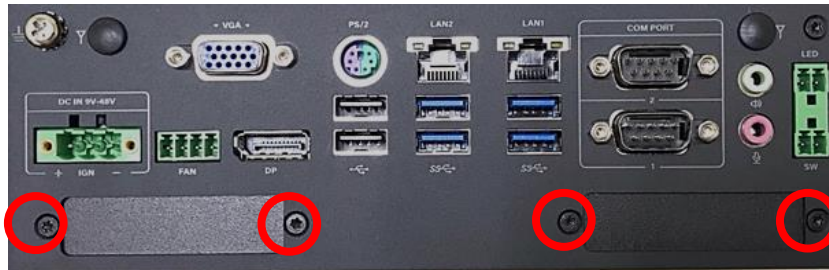

2. Attach the I/O bracket on to the system as indicated below, and fasten the screws back to fix it. For guidance on antenna installation methods, please refer to chapter 3.6.



3.8 Installing Antenna Cutout Universal Bracket (Front)

An optional Universal Bracket (Model No. UB1032) features three antenna cutouts. This bracket allows users to mount antennas in the designated cutouts. For Antenna installation details, refer to chapter 3.6.

Step 1. From the rear of the front panel, remove two hex nuts on either the left or the right side and remove the corresponding cover plate (see below). The cover plate on the right is used as the example here.

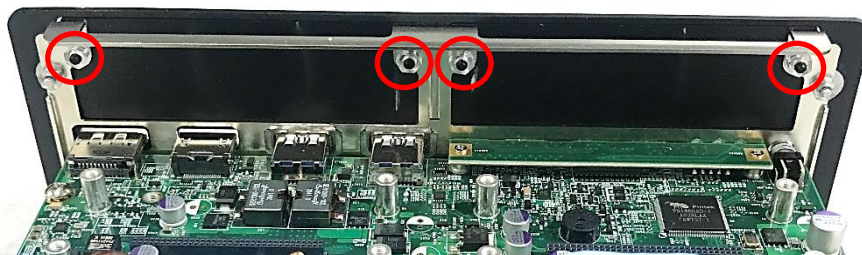

Step 2. Install the UB and secure it in place with two hex nuts as indicated below.

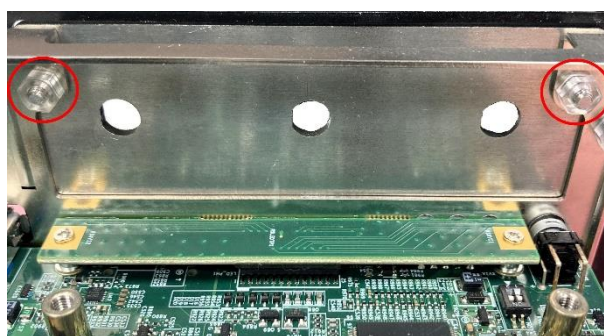

3.9 Installing SATA Hard Drive on Top Side

1. Unscrew the 3 screws on the HDD bracket and remove the bracket.

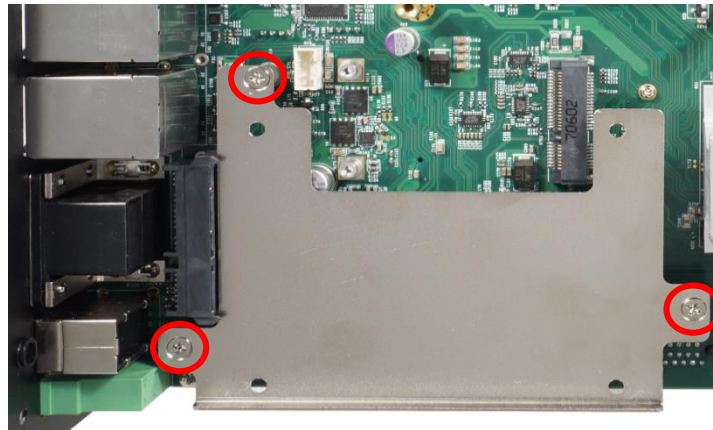

2. Make the PCB side of the HDD face up, and place the HDD bracket on it. Ensure the direction of bracket is correct and use the provided 4 screws to assemble HDD and HDD bracket together.

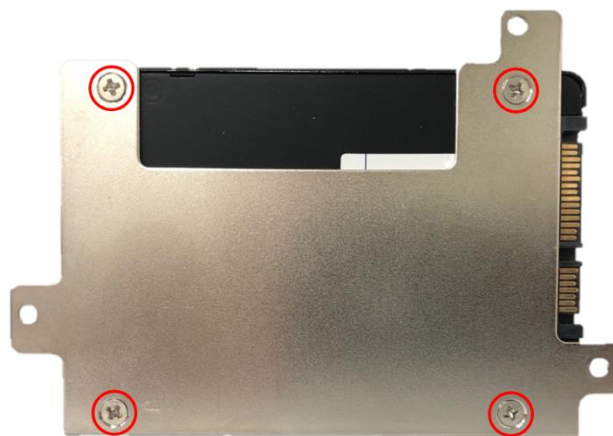

3. Turn over the HDD bracket. Connect the HDD bracket to the SATA connector and fasten the 3 screws.

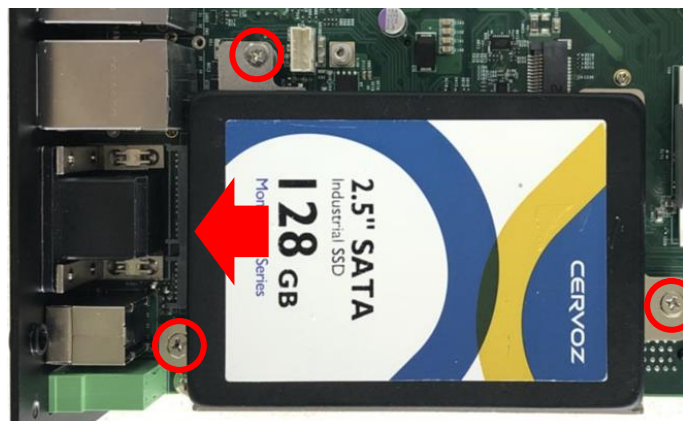

3.10 Installing PCI/PCIe Add-on Card

(For DS-1301 and DS-1302 only)

The applicable riser cards for DS-1300 series are listed in the following table.

Model No.	Description	Compatible Model
RC-E16-01	Riser Card with 1 x PCIe16 Slot	DS-1301
RC-PI-01	Riser Card with 1 x PCI Slot	DS-1301
RC-E8E8-R10	Riser Card with 2 x PCIe8 Slots	DS-1302
RC-E16E1-01	Riser Card with 1 x PCIe16 and 1 x PCIe1 Slots	DS-1302
RC-E16PI-01	Riser Card with 1 x PCIe16 and 1 x PCI Slots	DS-1302
RC-PIPI-01	Riser Card with 2 x PCI Slots	DS-1302

Please note that this section uses Riser Card Model No. RC-E8E8-R10 as an example for installation.

1. Prepare a Riser Card intended for installation.



Riser Card [RC-E8E8-R10](#)

2. Unscrew the 4 screws to remove the extension bracket.

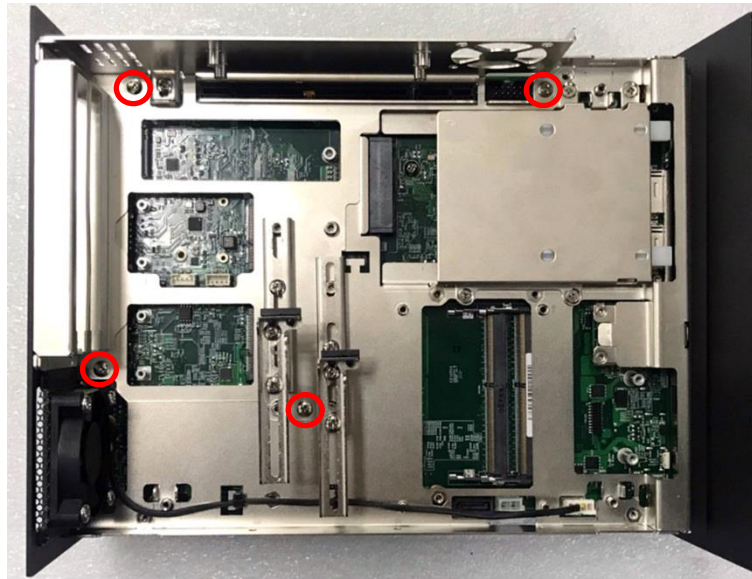

3. Assemble the riser card with extension bracket together and fasten with the 4 screws (M3x5L).

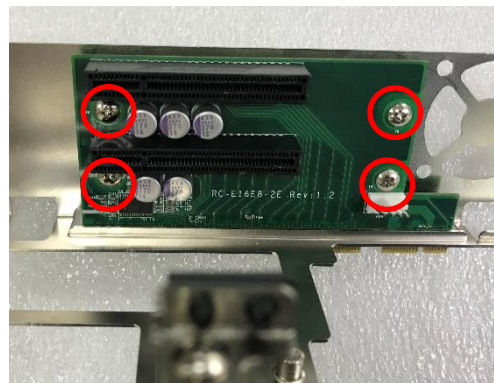
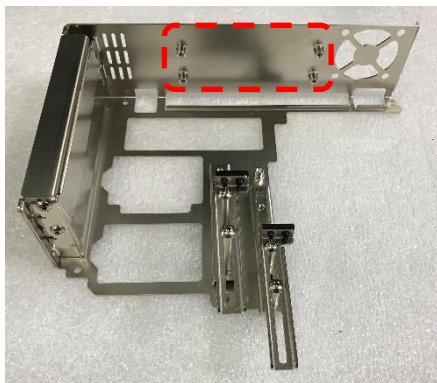

4. (1) Loosen the screw(s) to remove I/O bracket(s). (2) Loosen the screws halfway to allow the card retainer to be adjustable.

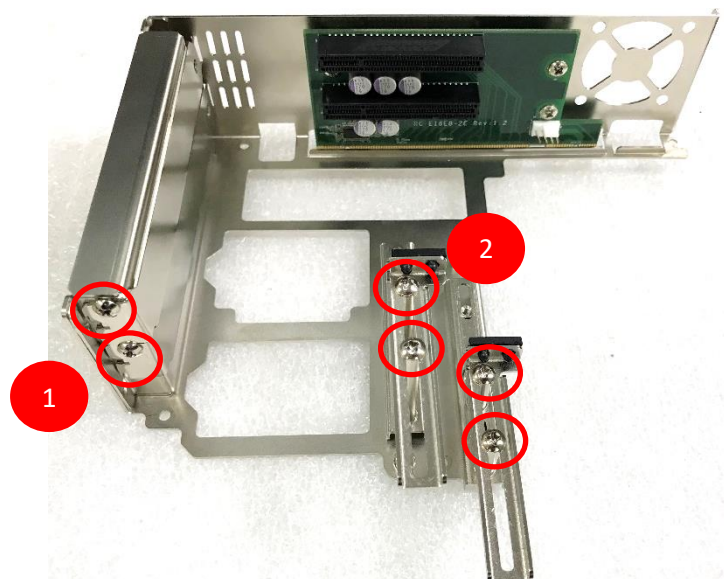

5. (1) Insert PCI(e) add-on card to the slot. (2) Fasten the screw to secure it

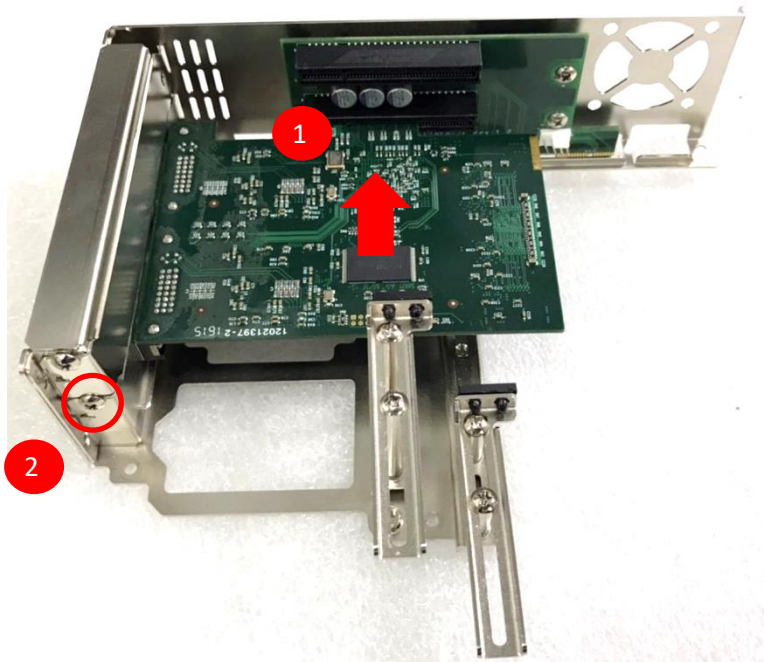

6. (1) Push the card retainer forward to against the edge of the add-on card. (2) Fasten the screws to fix the card retainer.

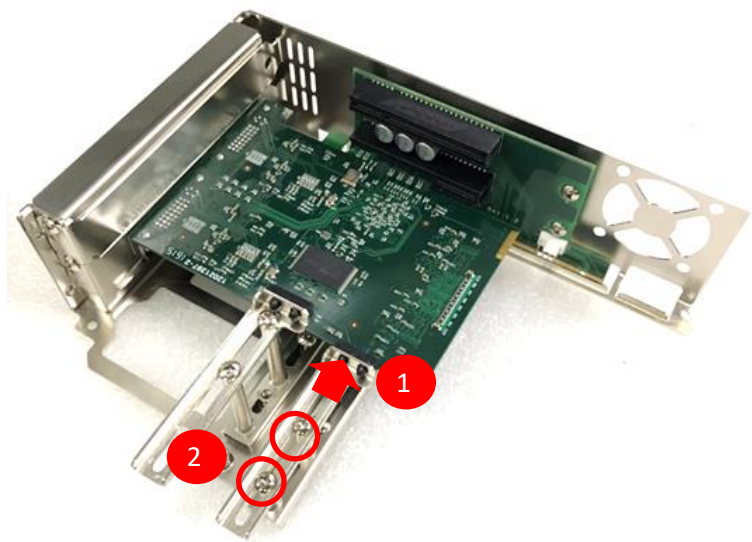

7. Locate the riser card slot on bottom side of system.

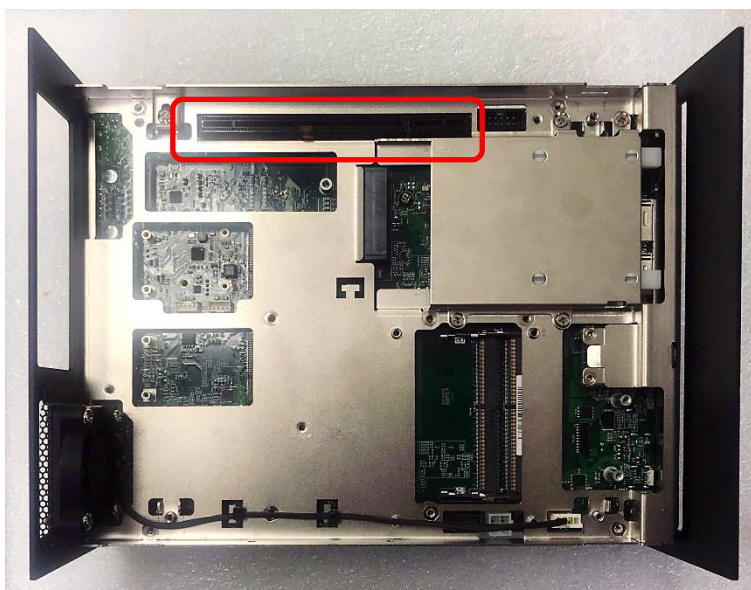

8. Install the module assembled in step 6 into the riser card slot, and fasten the 4 screws to secure it. Loosen the latches (see Section 3.1, step 4) if necessary for ease of installation. Ensure the bracket or the riser card does not crush the thermistor.

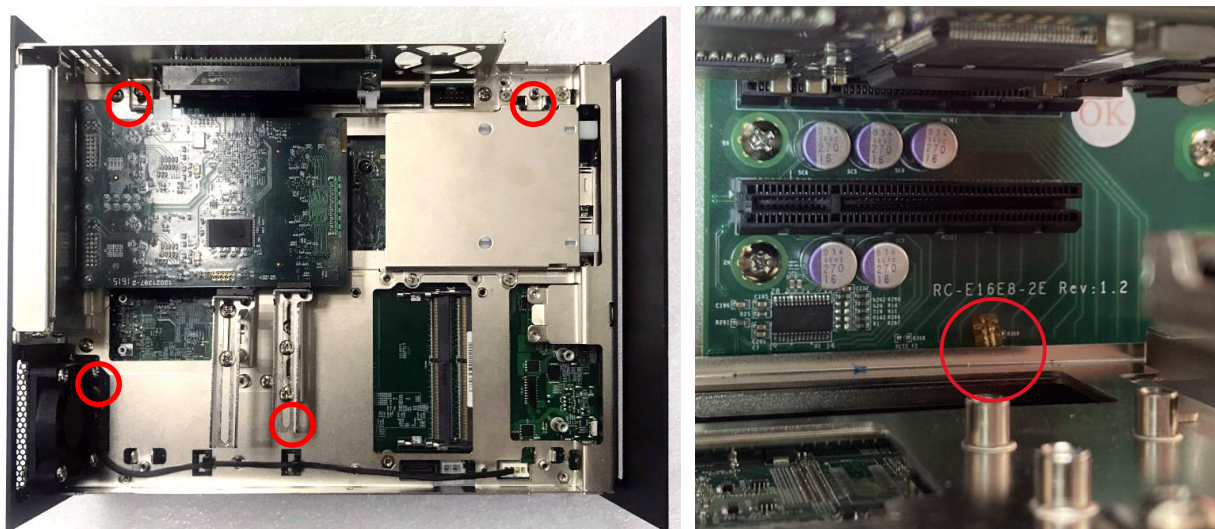

WARNING
(AVERTIR)

Ensure the bracket or the riser card does not crush the thermistor. Failure to follow this step may damage the sensor.

(S'assurer que le support ou la carte d'extension ne comprime pas la thermistance. Le non-respect de cette étape peut endommager le capteur.)

3.11 Assembling Top Cover

1. Make sure the notch on the chassis and the front bezel of the unit body are on the same side.

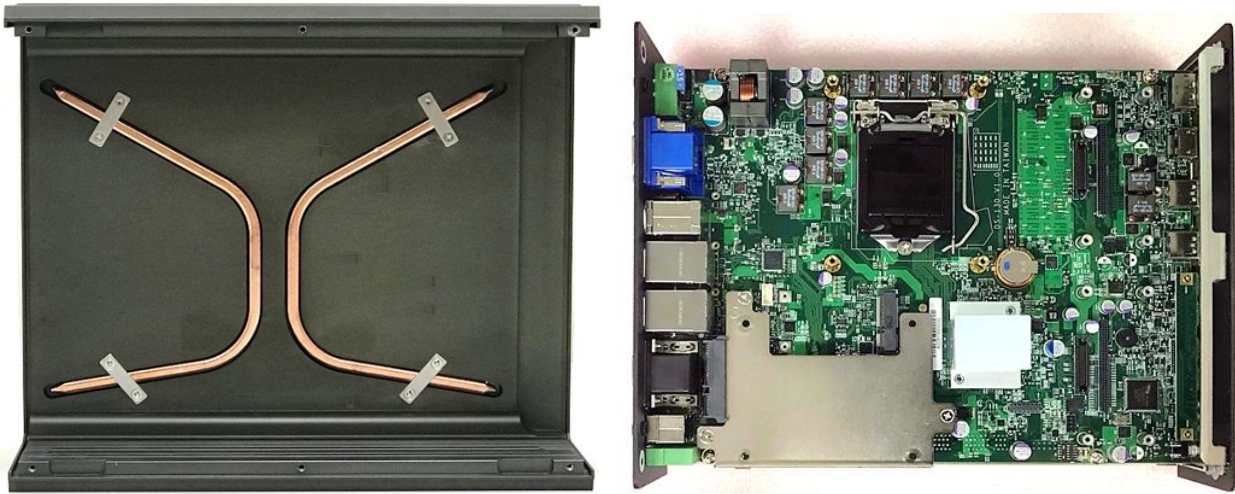

2. Lift the body of the unit, make sure that the front and rear panels are in the chassis grooves, and then assemble the body into the chassis.

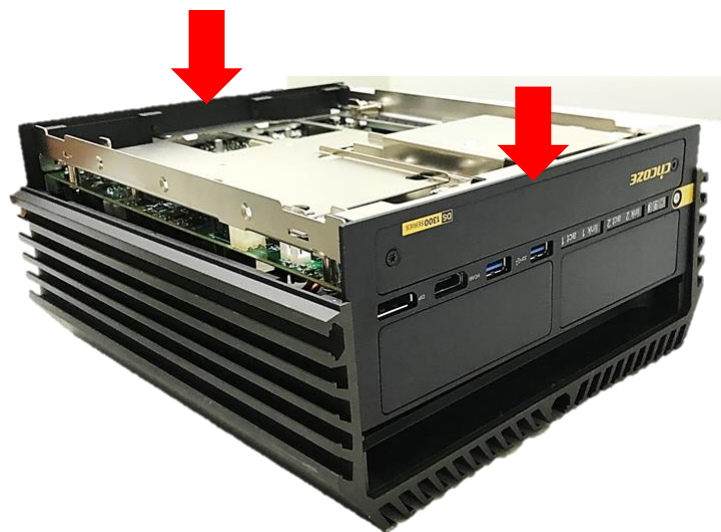

3. Push into the 4 latches as indicated and fasten the 4 screws.

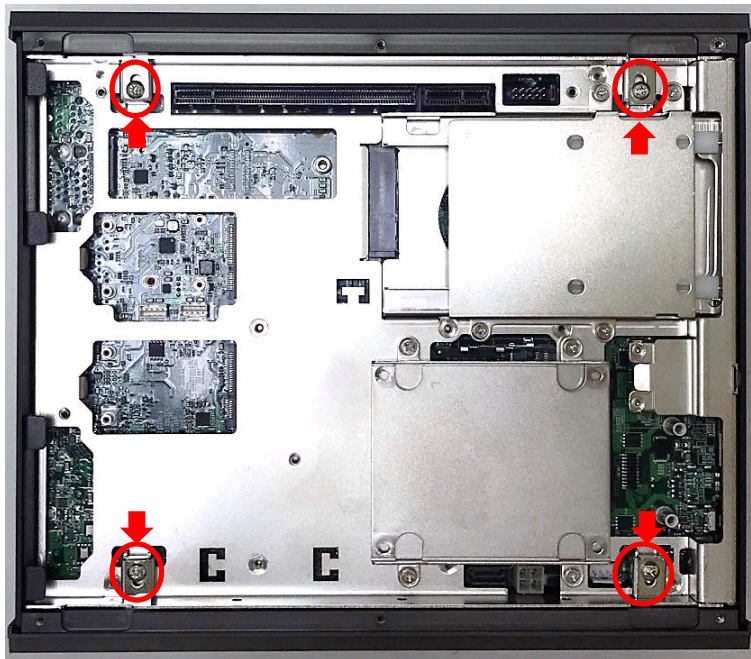

4. Fasten the 2 screws at rear panel.



5. Be sure to align the grooves with front and rear panels. Put the bottom cover back on and fasten the 6 screws to fix the cover.

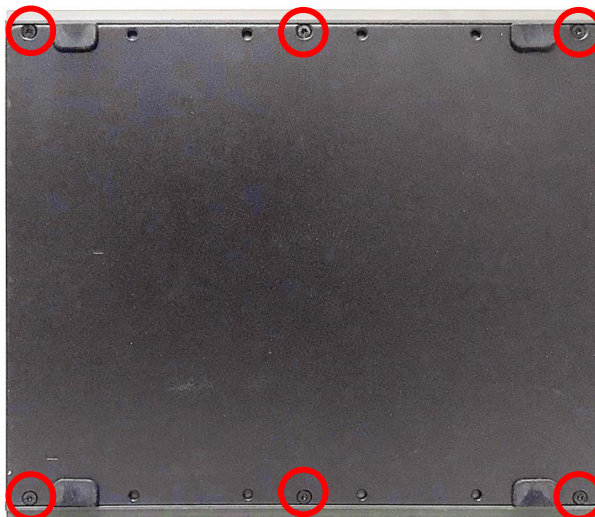

3.12 Installing SATA Hard Drives at Front Panel

1. Loosen the two screws to remove the cover plate of maintenance zone.



2. Loosen the screw to remove the HDD bay cover bracket.



3. Pull the rotating arm and pull the HDD bracket out of system.

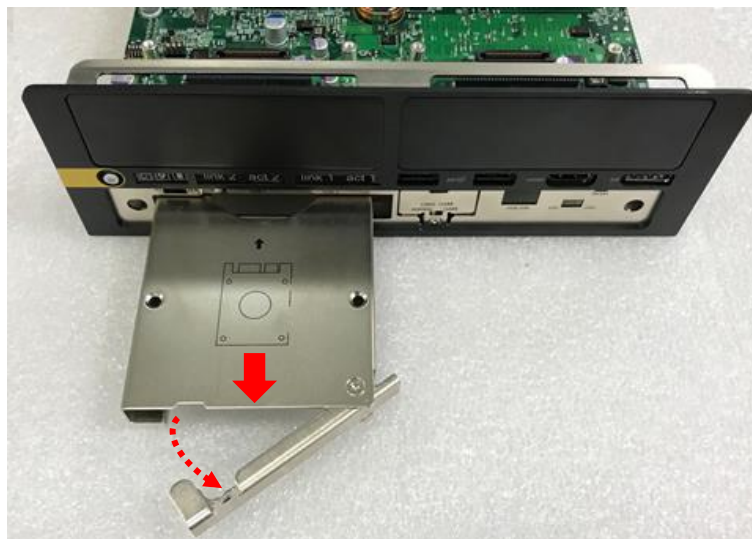

4. Make HDD bottom side face up, place the HDD bracket on it. Ensure the direction of bracket is correct and use 4 provided screws to assemble HDD and HDD bracket together.



5. Align the HDD bracket with the entrance of HDD bay. Insert the HDD bracket and push it until the HDD connector is fully inserted into the SATA slot.

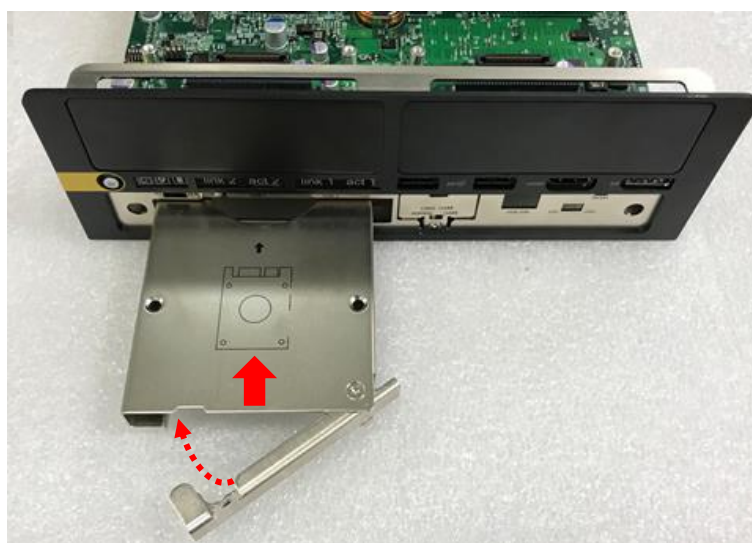

6. Place the rotating arm back and fasten the screw(s).



7. Fix the cover plate of maintenance zone by fastening the two screws.



3.13 Installing SIM Card

1. Loosen the two screws to remove the cover plate of maintenance zone.



2. Locate the SIM card slot at front side and insert a SIM card into a SIM slot with the gold contacts facing up. Please pay attention to the insert orientation as illustrated.



3. Fix the cover plate of maintenance zone by fastening the two screws.



3.14 Replacing CMOS Battery

1. Loosen the two screws to remove the cover plate of maintenance zone.



2. Locate the removable CMOS Battery and loosen the screw.



3. Pull out the CMOS battery bracket with assistance of a tweezer.



4. Remove the battery by pressing the metal tab backwards slightly as indicated.

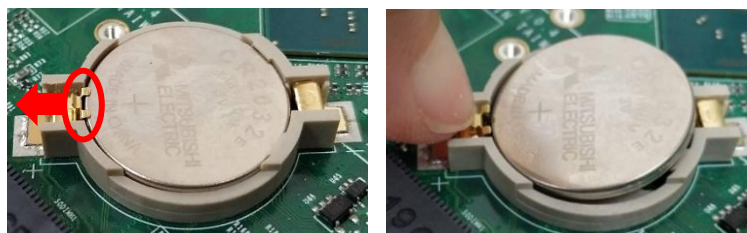

5. Pay attention to the direction of "+" and "-" signs on the battery. Push the battery into the slot from the "-" side and pull the metal tab backwards to make the battery fully installed in the slot.

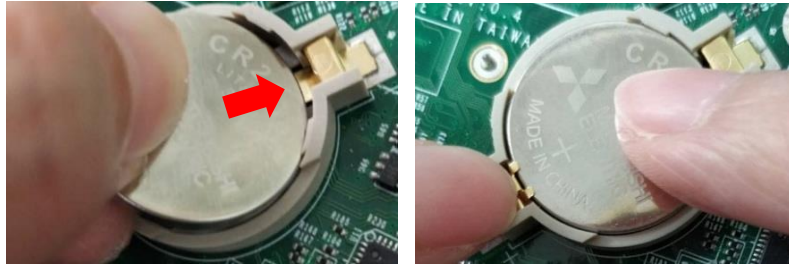

6. Insert the battery bracket firmly.

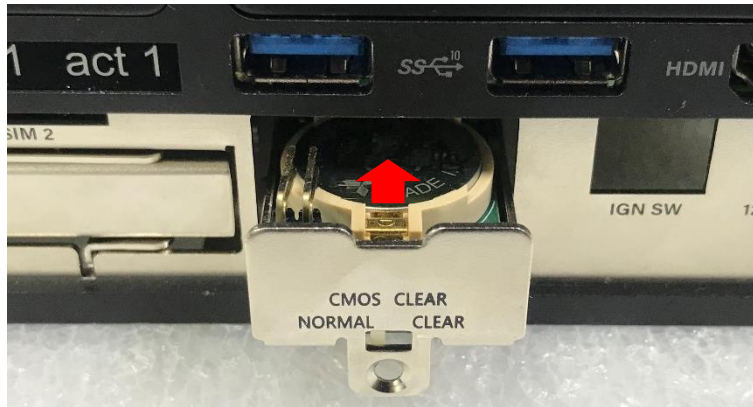

7. Fasten the screw.



8. Fix the cover plate of maintenance zone by fastening the two screws.



3.15 Installing Wall Mount

DS-1300 series offers wall mount kit that customers can install the system on the wall in a convenient and economical way.



1. The mounting holes are at the bottom side of the system. Use the provided 8 screws (M5x6L) to fasten the bracket and the system together.



2. Fasten the screws through the bracket mounting holes to mount the system onto the wall.

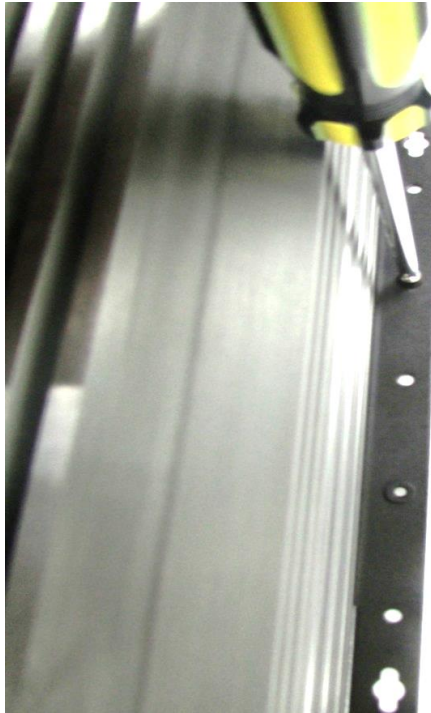

3.16 Connecting to Power Supply

1. Locate the DC_IN1 power connector.



2. Aim the V- wire at the V- port of the connector, and aim the V+ wire at the V+ port of the connector. Then connect the phoenix contacts of the power supply to the DC_IN connector.

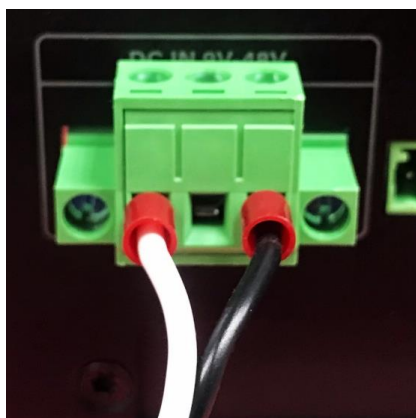

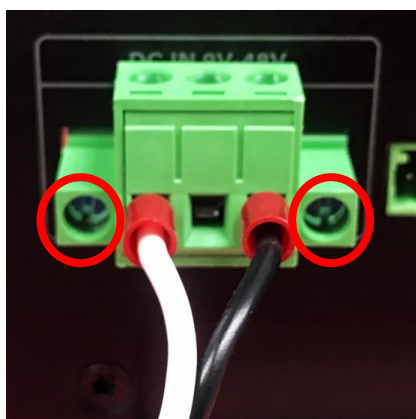

3. Fasten the two screws to fix the phoenix contacts.



WARNING
(AVERTIR)

To avoid power-related issues, use a new power supply and ensure the screws are properly tightened.

(Pour éviter les problèmes liés à l'alimentation électrique, utilisez une nouvelle source d'alimentation et assurez-vous que les vis sont bien serrées.)



Chapter 4

BIOS Setup

4.1 BIOS Introduction

The BIOS (Basic Input/ Output System) is a program located on a Flash Memory on the motherboard. When you start the computer, the BIOS program will gain control. The BIOS first operates an auto-diagnostic test called POST (power on self-test) for all the necessary hardware, it detects the entire hardware device and configures the parameters of the hardware synchronization.

BIOS Setup

Power on the computer and by pressing immediately allows you to enter Setup. If the message disappears before your respond and you still wish to enter Setup, restart the system to try again by turning it OFF then ON or pressing <Ctrl>, <Alt> and <Delete> keys.

Control Keys	
<←> <→>	Move to select screen
<↑> <↓>	Move to select item
<Esc>	Quit the BIOS Setup
<Enter>	Select item
<Page Up/+>	Increases the numeric value or makes changes
<Page Down/->	Decreases the numeric value or makes changes
<Tab>	Select setup fields
<F1>	General help
<F2>	Previous value
<F3>	Load Optimized defaults
<F10>	Save configuration and Exit

Main Menu

The main menu lists the setup functions you can make changes to. You can use the arrow keys (↑↓) to select the item. The on-line description of the highlighted setup function is displayed at the bottom of the screen.

Sub-Menu

If you find a right pointer symbol appears to the left of certain fields that means a sub-menu can be launched from this field. A sub-menu contains additional options for a field parameter. You can use arrow keys (↑↓) to highlight the field and press <Enter> to call up the sub-menu. Then you can use the control keys to enter values and move from field to field within a sub-menu. If you want to return to the main menu, just press the <Esc >.

4.2 Main Setup

Press to enter BIOS CMOS Setup Utility, the Main Menu (as shown below) will appear on the screen. Use arrow keys to move among the items and press <Enter> to accept or enter a sub-menu.

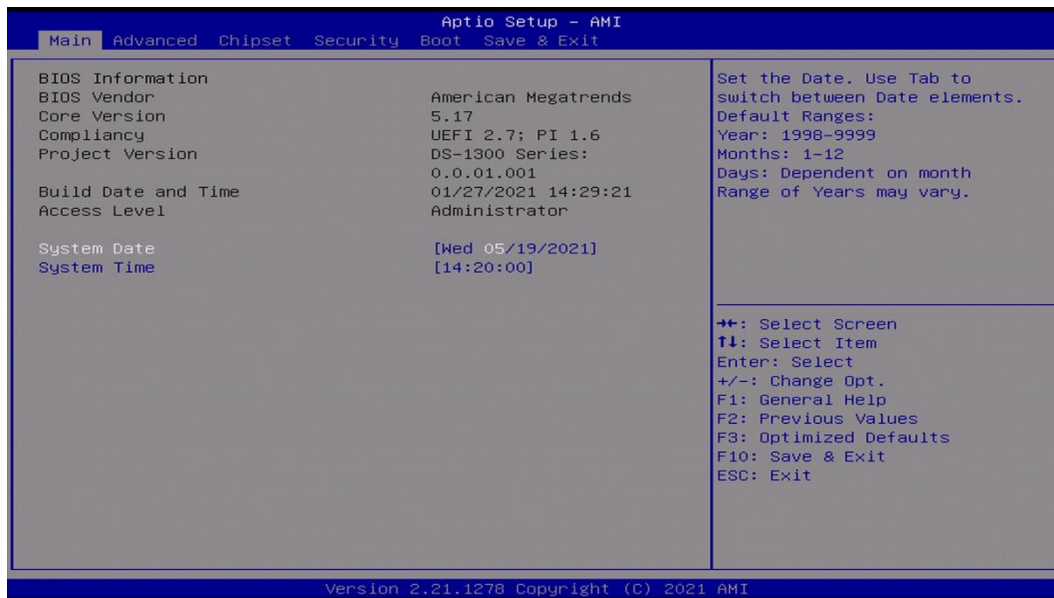

4.2.1 System Date

Set the date. Please use <Tab> to switch between date elements.

4.2.2 System Time

Set the time. Please use <Tab> to switch between time elements.

4.3 Advanced Setup

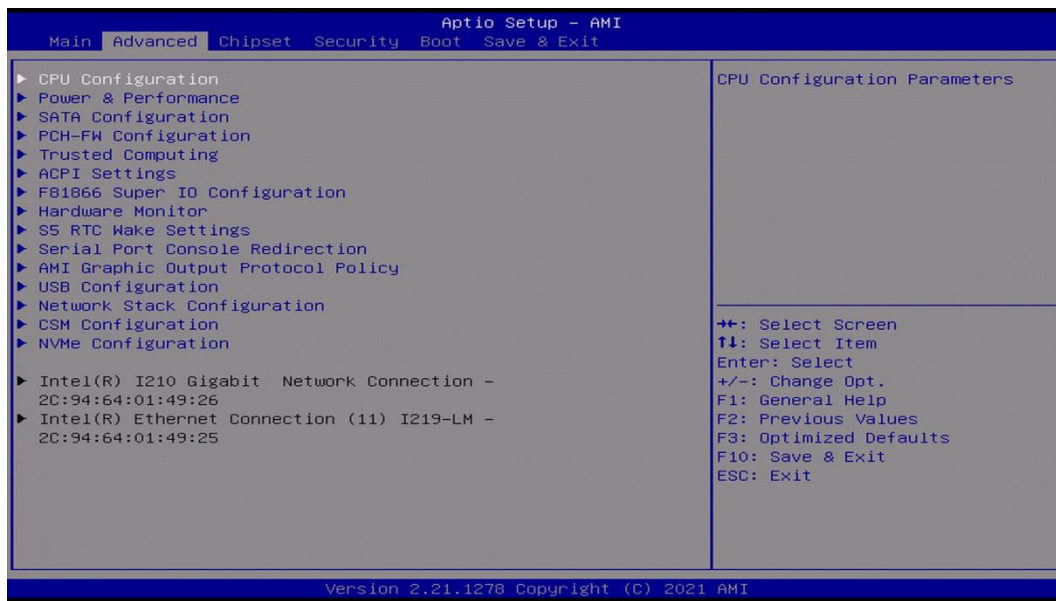

4.3.1 CPU Configuration

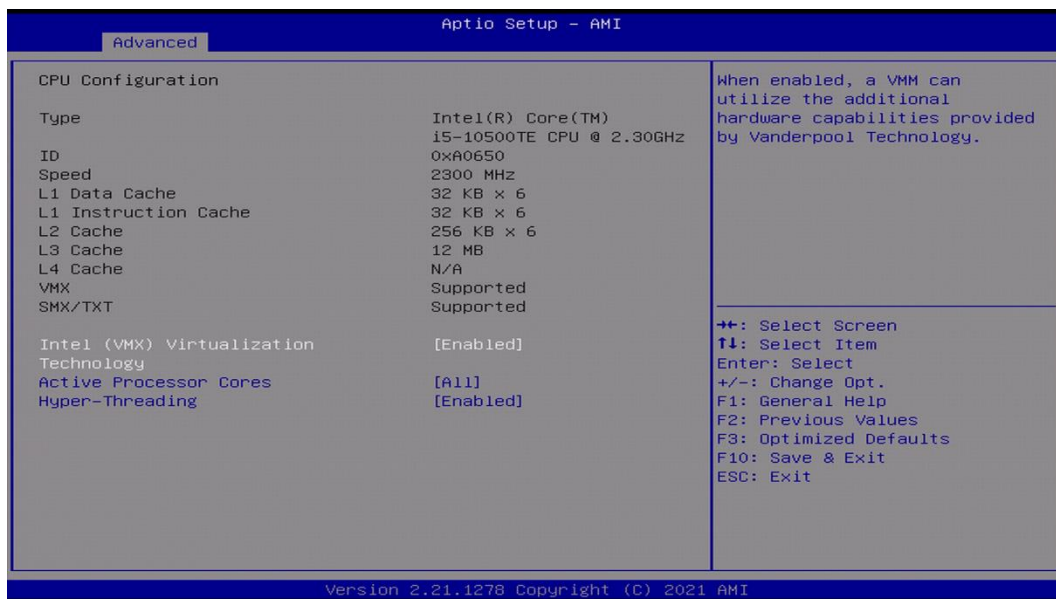

■ Intel® (VMX) Virtualization Technology [Enabled]

Enables or disables Intel® Virtualization Technology. Virtualization enhanced by Intel® Virtualization Technology will allow a platform to run multiple operating systems and applications in independent partitions. With virtualization, one computer system can function as multiple virtual systems.

■ Active Process Cores [All]

Allows users to choose the number of active processor cores.

Configuration options: [All] [1] [2] [3] [4] [5]

■ Hyper-threading

Enables or disables for Hyper-Threading Technology.

4.3.2 Power & Performance

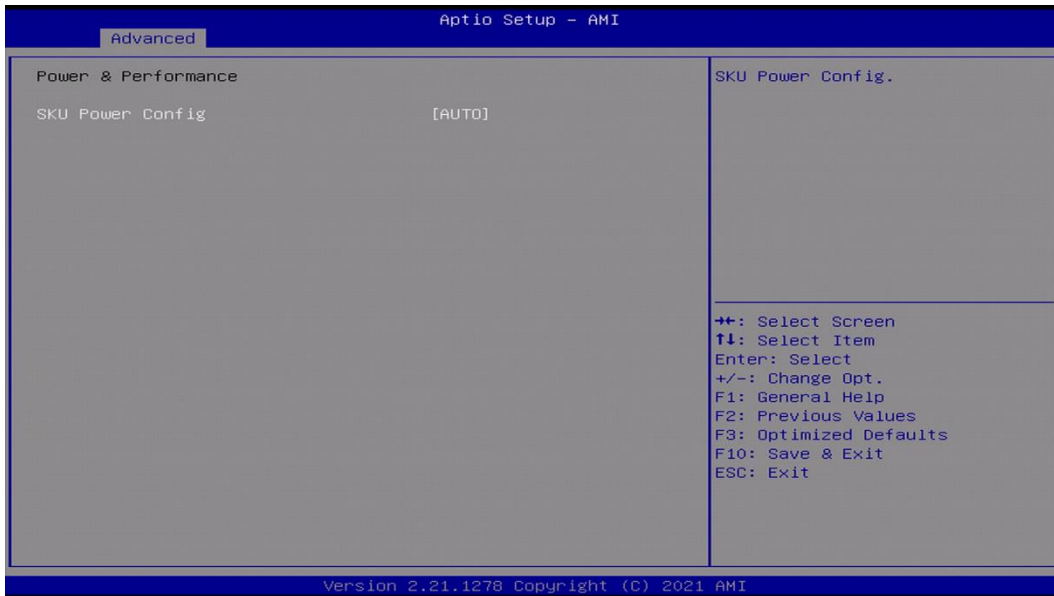

■ SKU Power Config [Auto]

Allows users to choose the upper limit of CPU power.

Configuration options: [Auto] [35W]

4.3.3 SATA Configuration

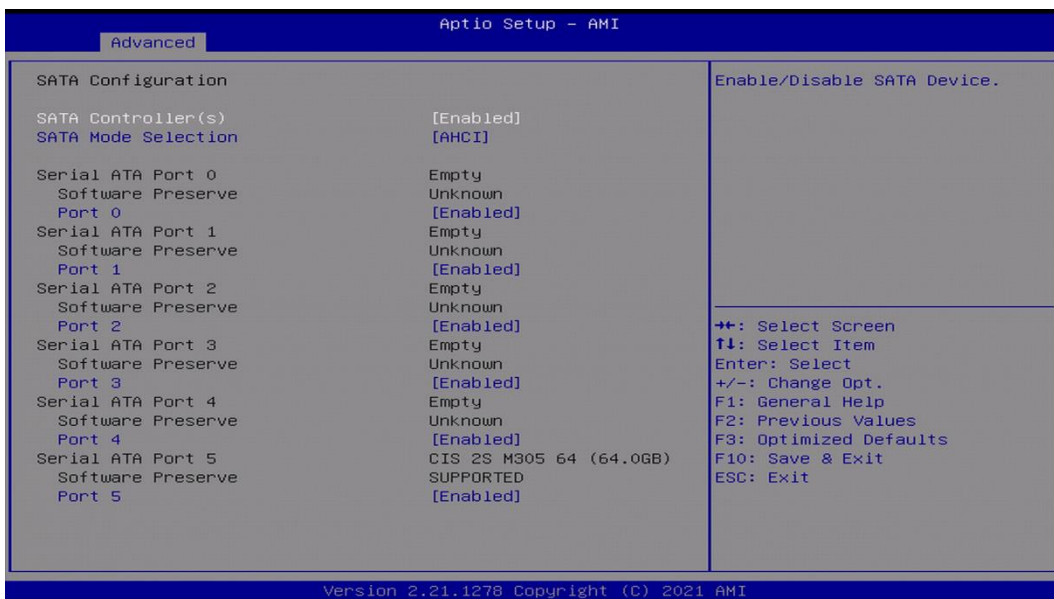

■ SATA Controller(s) [Enabled]

Enables or disables Serial ATA controller.

■ SATA Mode Selection [AHCI]

This item allows users to choose [AHCI] or [RAID] mode.

- Serial ATA Port 0**
Port 0 [Enabled]
Enables or disables SATA Port 0.
- Serial ATA Port 1**
Port 1 [Enabled]
Enables or disables SATA Port 1.
- Serial ATA Port 2**
Port 2 [Enabled]
Enables or disables SATA Port 2.
- Serial ATA Port 3**
Port 3 [Enabled]
Enables or disables SATA Port 3.
- Serial ATA Port 4**
Port 4 [Enabled]
Enables or disables SATA Port 4.
- Serial ATA Port 5**
Port 5 [Enabled]
Enables or disables SATA Port 5.

4.3.4 PCH-FW Configuration



■ Intel AMT [Enabled]

Allows users to enable or disable Intel® Active Management Technology BIOS execution.

■ Firmware Update Configuration



□ ME FW Image Re-Flash [Disabled]

Allows users to enable or disable ME firmware image re-flash function.

4.3.5 Trusted Computing



■ Security Device Support [Enable]

Allow users to enable or disable Security Device Support function.

■ SHA-1 PCR Bank [Disabled]

Enables or disables SHA-1 PCR Bank function.

■ **SHA256 PCR Bank [Enabled]**

Enables or disables SHA256 PCR Bank function.

■ **Pending Operation [None]**

Allows users to select which mode Pending Operation will operate.

Configuration options: [None], [TPM Clear]

■ **Platform Hierarchy [Enabled]**

Enables or disables Platform Hierarchy function.

■ **Storage Hierarchy [Enabled]**

Enables or disables Storage Hierarchy function.

■ **Endorsement Hierarchy [Enabled]**

Enables or disables Endorsement Hierarchy function.

■ **Physical Presence Spec Version [1.3]**

Allows users to select which mode Physical Presence Spec Version will operate.

Configuration options: [1.2], [1.3]

4.3.6 ACPI Settings

This item allows users to configure ACPI settings.

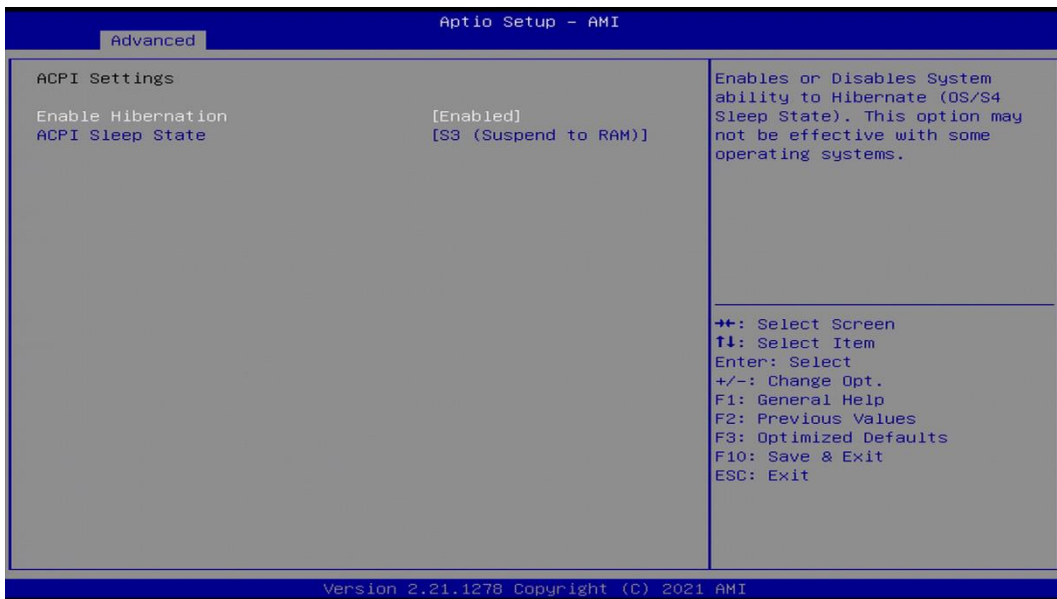

■ **Enable ACPI Auto Configuration [Enabled]**

Enables or disables BIOS Advanced Configuration Power Interface® (ACPI) auto configuration.

■ **ACPI Sleep State [S3 (Suspend to RAM)]**

Allows users to select the highest Advanced Configuration Power Interface® (ACPI) sleep state that system will enter when suspend button is pressed.

[Suspend Disabled]: Disables entering suspend state.

[S3 (suspend to RAM)]: Enables suspend to RAM state.

4.3.7 F81866 Super IO Configuration

The screen allows users to select options for the Super IO configuration, and change the value of the selected option.

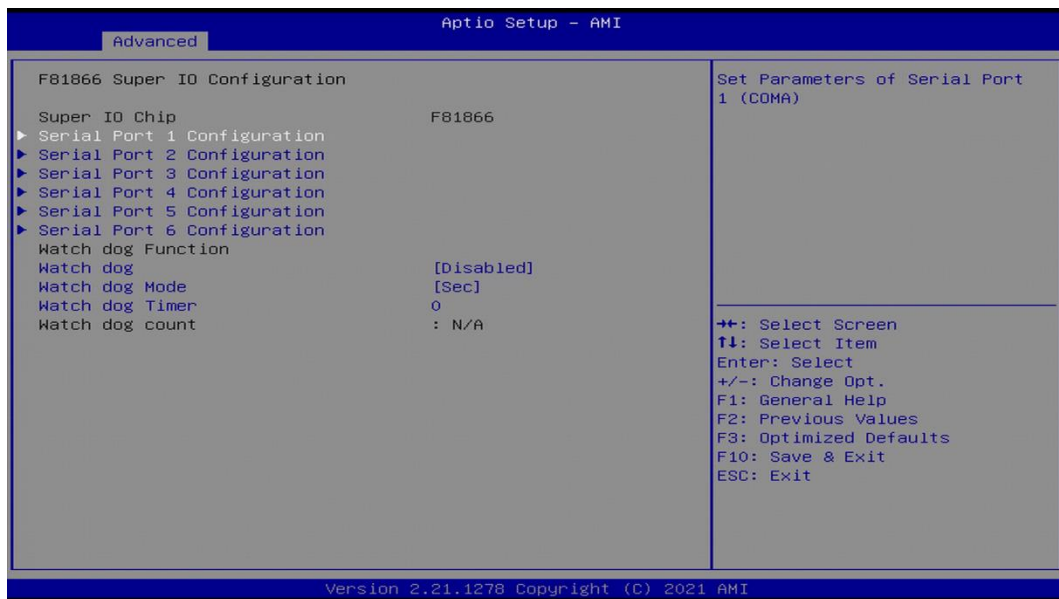

Serial Port 1~4 Configuration

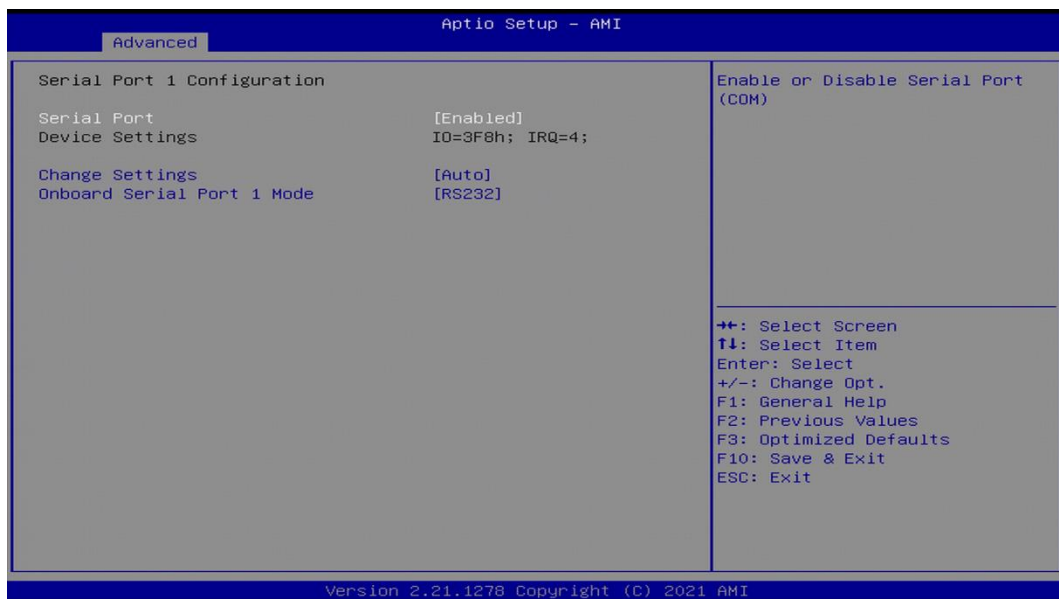

Serial Port [Enabled]

This item allows users to enable or disable serial port.

Change Settings [Auto]

This item allows users to change the address & IRQ settings of the specified serial port.

Onboard Serial Port 1 Mode [RS232]

This item allows users to select Serial Port Mode.

Configuration options: [RS232] [RS422/RS485 Full Duplex] [RS485 Half Duplex]

■ Watch Dog [Disabled]

Enables or disables watch dog function.

■ Watch Dog Mode [Sec]

Changes the Watch dog mode. Select [Sec] or [Min] mode.

■ Watch Dog Timer [0]

User can set a value in the range of 0 to 255.

4.3.8 Hardware Monitor

These items display the current status of all monitored hardware devices/ components such as voltages and temperatures.

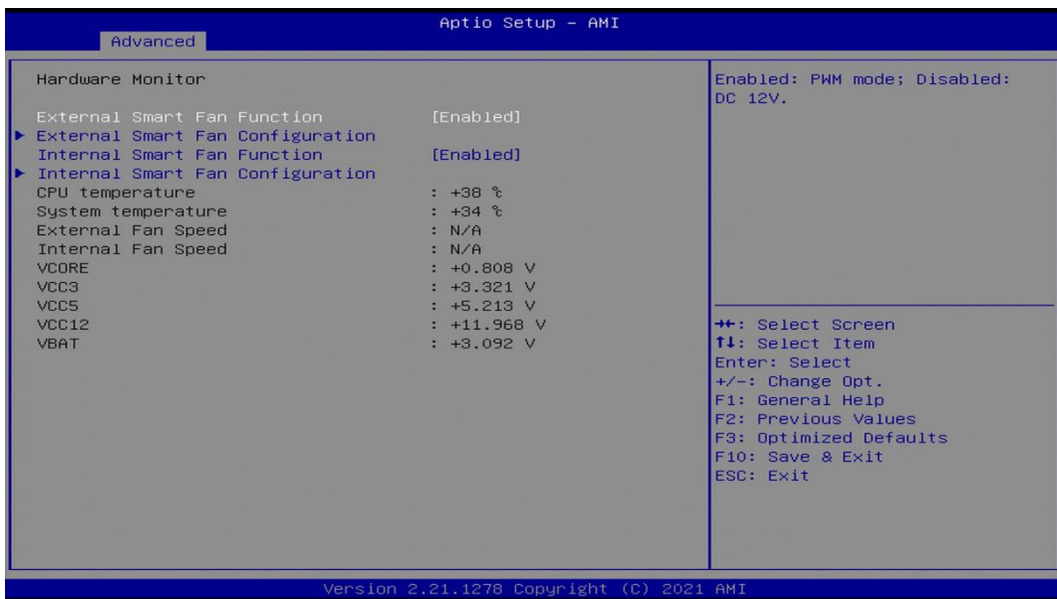

■ External Smart Fan Function [Enabled]

Enables or disables external smart fan function.

■ External Smart Fan Configuration

Allows users to setting external smart fan parameters.

■ Internal Smart Fan Function [Enabled]

Enables or disables internal smart fan function.

■ Internal Smart Fan Configuration

Allows users to setting internal smart fan parameters.

4.3.9 S5 RTC Wake Settings



Wake System from S5 [Disabled]

This item allows users to change the way to wake system from S5 state.

[Fixed Time]: Set the specified time (HH:MM:SS) to wake system.

[Dynamic Time]: Set the increase time from current time to wake system.

4.3.10 Serial Port Console Redirection

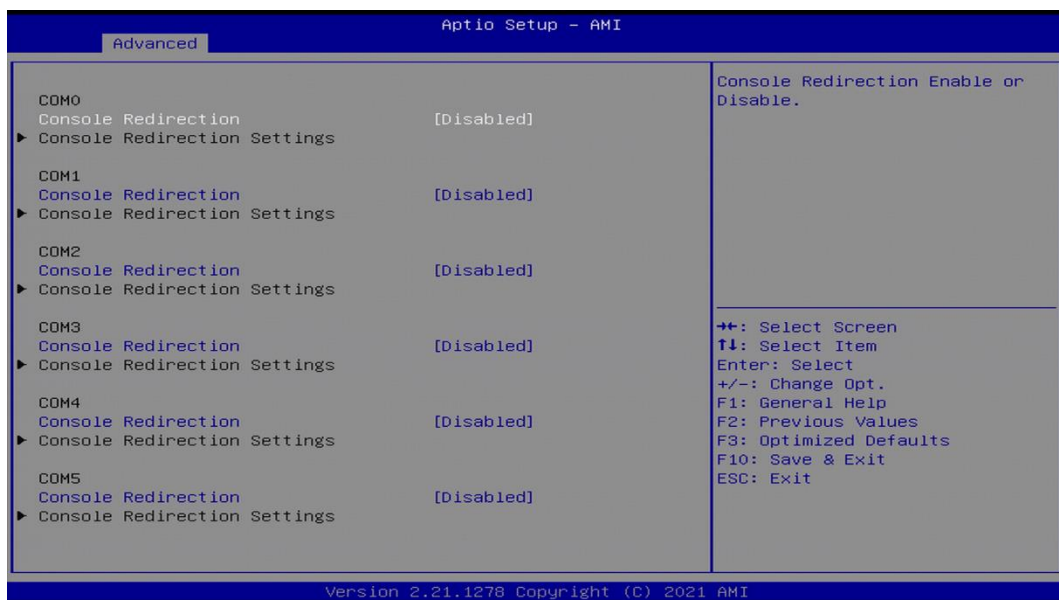

Console Redirection [Disabled]

These items allow users to enable or disable COM0, COM1, COM2, COM3, COM4, COM5 console redirection function.

4.3.11 AMI Graphic Output Protocol Policy



■ Output Select

Allows users to select which Output Interface to display under BIOS mode. The options shown in this item depend on the displays connected to the system.

[EDP1]: VGA

[HDMI1]: HDMI

[DP2]: DP (Front Panel)

[DP3]: DP (Rear Panel)

4.3.12 USB Configuration

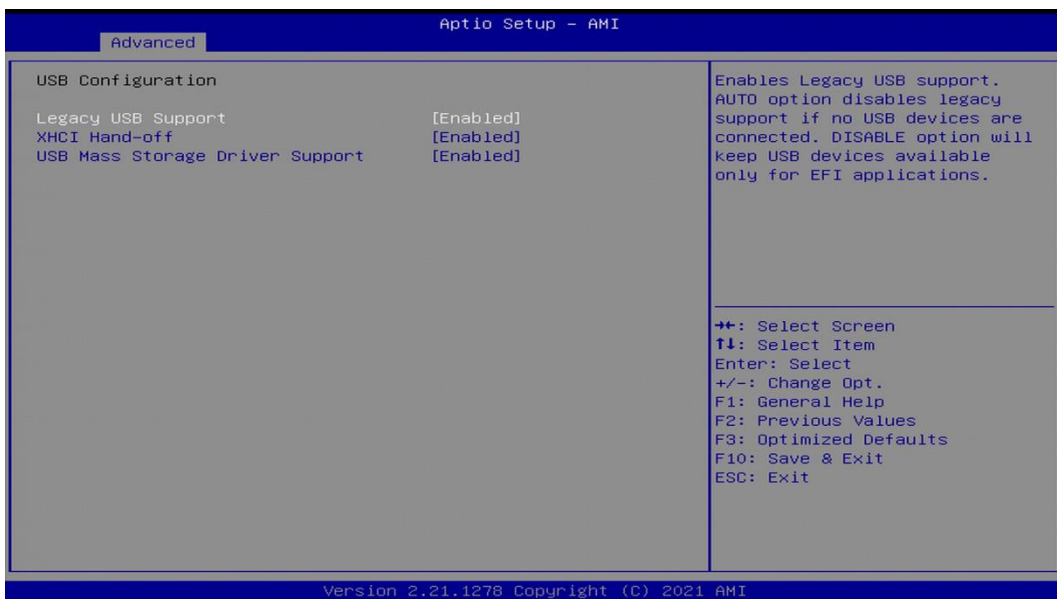

■ Legacy USB Support [Enabled]

This item allows users to enable or disable legacy USB support. When set to [Auto], legacy USB support will be disabled automatically if no USB devices are connected.

■ XHCI Hand-off [Enabled]

This item allows users to enable or disable XHCI (USB3.2) hand-off function.

■ USB Mass Storage Driver Support [Enabled]

Enables or disables support for USB mass storage devices.

4.3.13 Network Stack Configuration

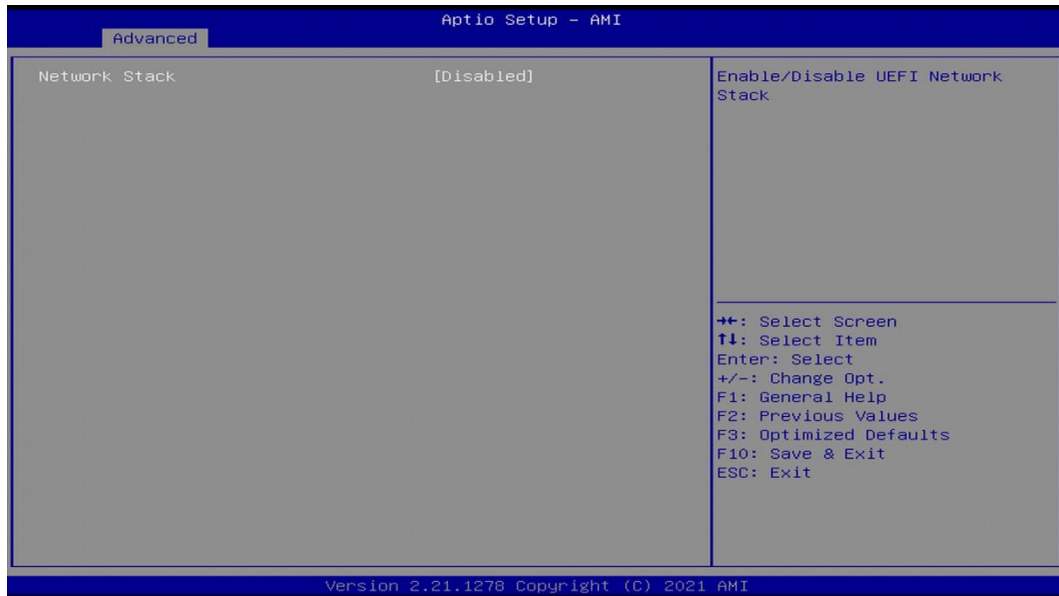

■ Network Stack [Disabled]

Enables or disables UEFI Network Stack.

4.3.14 CSM Configuration

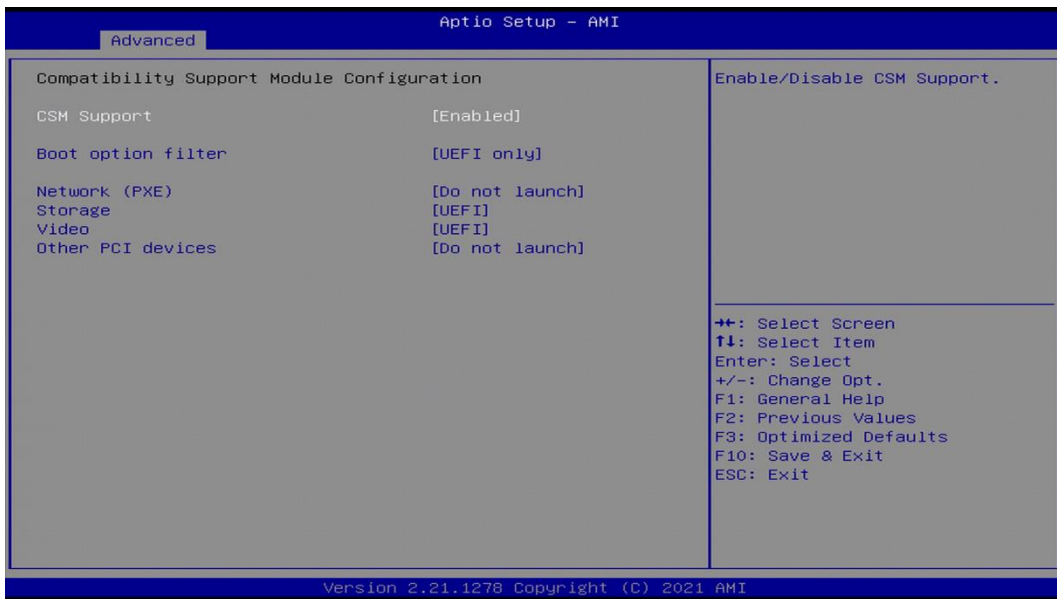

■ CSM Support [Enabled]

Enables or disables compatibility support module.

■ Boot option filter [UEFI only]

Allows users to select which type of operating system to boot.

[UEFI and Legacy]: Allows booting operating systems that support legacy or UEFI option ROM.

[Legacy only]: Allows booting operating systems that only support legacy option ROM.

[UEFI only]: Allows booting operating systems that only support UEFI option ROM.

■ Network PXE [Do not launch]

Controls the execution of UEFI and Legacy PXE (Network Preboot eXecution Environment) option ROM.

[Do not launch]: Disables option ROM execution.

[UEFI]: Enables UEFI option ROM only. [Legacy]: Enables legacy option ROM only.

■ Storage [UEFI]

Controls the execution of UEFI and Legacy Storage option ROM.

[Do not launch]: Disables option ROM execution.

[UEFI]: Enables UEFI option ROM only.

[Legacy]: Enables legacy option ROM only.

■ Video [UEFI]

Controls the execution of UEFI and Legacy Video option ROM.

[Do not launch]: Disables option ROM execution.

[UEFI]: Enables UEFI option ROM only.

[Legacy]: Enables legacy option ROM only.

■ Other PCI devices [Do not launch]

Allows users to determine option ROM execution policy for device other than network, storage, or video.

Configuration options: [Do not launch] [UEFI] [Legacy]

4.3.15 NVMe Configuration

The screen allows users to select options for the NVMe configuration, and change the value of the selected option. If there is NVMe Device detected, the options will show as the NVMe Device is found.

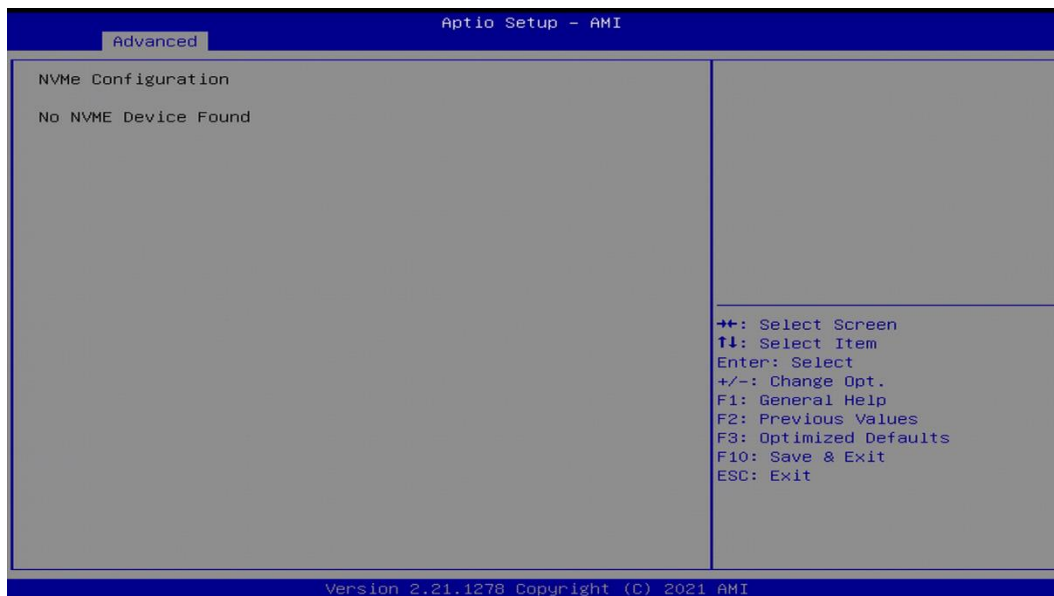

4.4 Chipset Setup

This section allows you to configure chipset related settings according to user's preference.

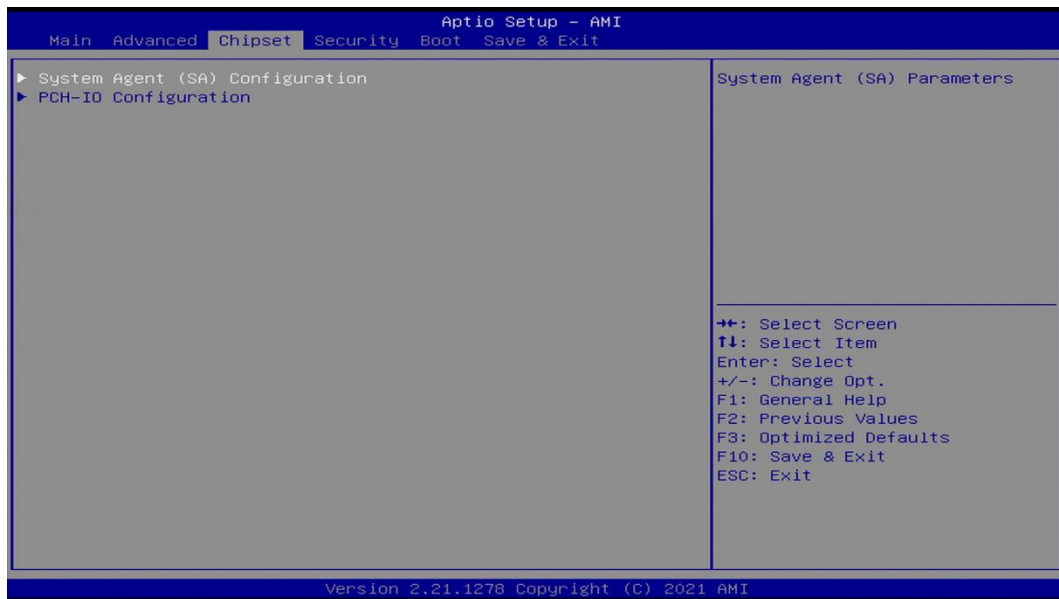

4.4.1 System Agent (SA) Configuration

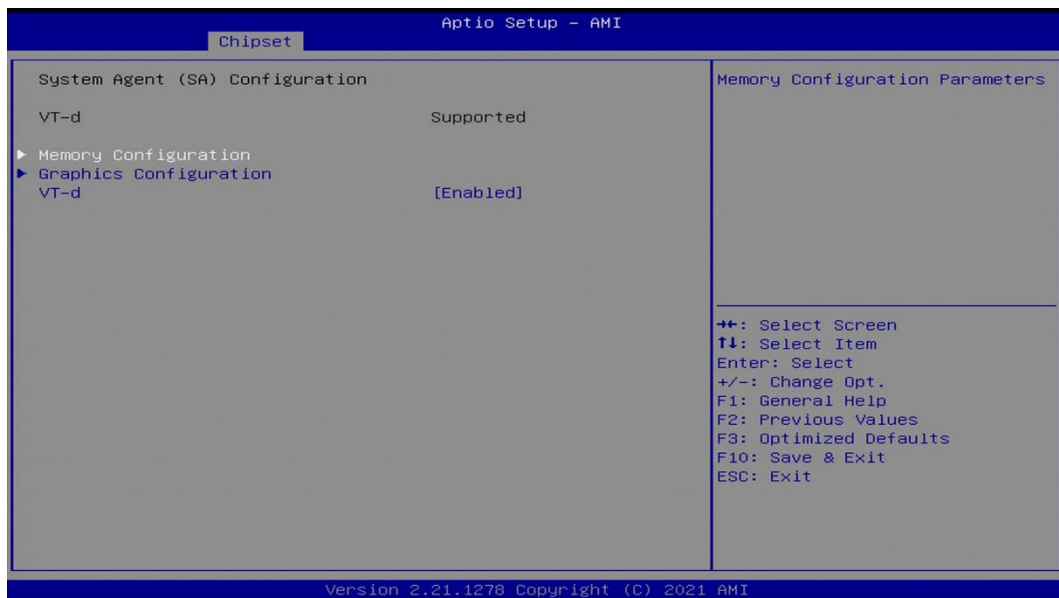

■ Memory Configuration

This item displays detailed memory information in the system.



■ Graphics Configuration



Primary Display [Auto]

Allows users to select which graphics device should be primary display or select SG for switchable graphics.

Configuration options: [Auto] [IGFX] [PEG]

Internal Graphics [Auto]

This item allows users to enable or disable Internal Graphics. When set to [Auto], it will detect by BIOS. Configuration options: [Auto] [Disabled] [Enabled]

■ VT-d [Enabled]

This item allows users to enable or disable Intel® Virtualization Technology for Directed I/O (VT-d) function.

4.4.2 PCH-IO Configuration

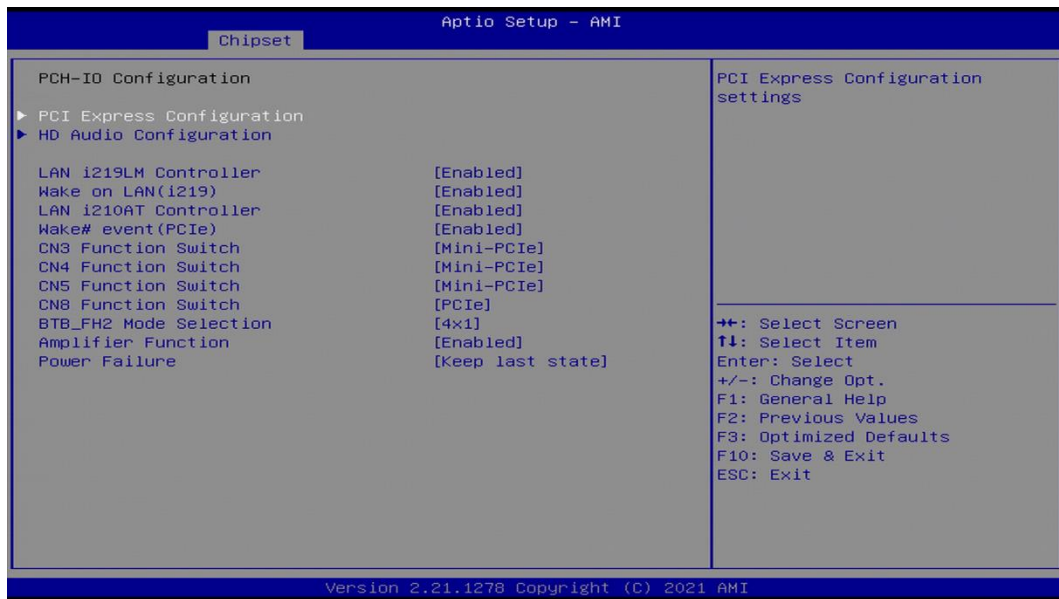

■ PCI Express Configuration

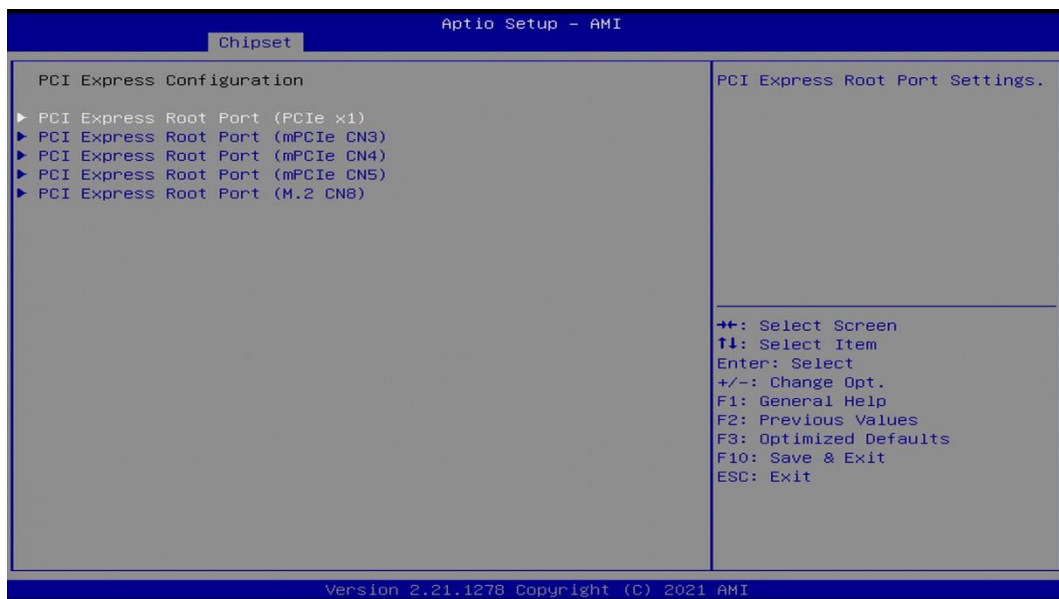

□ PCI Express Root Port (PCIe x1)

■ PCI Express Root Port [Enabled]

Allows you to enable or disable the PCI Express Port.

■ PCIe Speed [Auto]

Allows you to select PCI Express interface speed.

Configuration options: [Auto] [Gen1] [Gen2] [Gen3].

- ❑ **PCI Express Root Port (mPCIe CN3)**
 - **PCI Express Root Port [Enabled]**
Allows you to enable or disable the PCI Express Port.
 - **PCIe Speed [Auto]**
Allows you to select PCI Express interface speed.
Configuration options: [Auto] [Gen1] [Gen2] [Gen3].
- ❑ **PCI Express Root Port (mPCIe CN4)**
 - **PCI Express Root Port [Enabled]**
Allows you to enable or disable the PCI Express Port.
 - **PCIe Speed [Auto]**
Allows you to select PCI Express interface speed.
Configuration options: [Auto] [Gen1] [Gen2] [Gen3].
- ❑ **PCI Express Root Port (mPCIe CN5)**
 - **PCI Express Root Port [Enabled]**
Allows you to enable or disable the PCI Express Port.
 - **PCIe Speed [Auto]**
Allows you to select PCI Express interface speed.
Configuration options: [Auto] [Gen1] [Gen2] [Gen3].
- ❑ **PCI Express Root Port (M.2 CN8)**
 - **PCI Express Root Port [Enabled]**
Allows you to enable or disable the PCI Express Port.
 - **PCIe Speed [Auto]**
Allows you to select PCI Express interface speed.
Configuration options: [Auto] [Gen1] [Gen2] [Gen3].

■ HD Audio Configuration

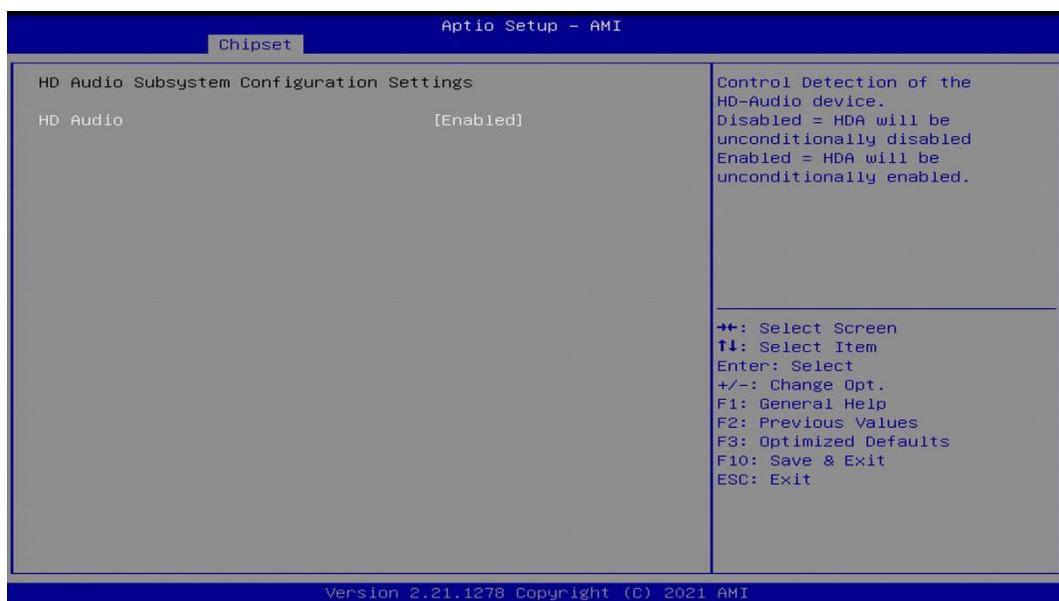

HD Audio [Enabled]

Allows you to select HD Audio options.

[Enabled]: HD Audio device is unconditionally enabled.

[Disabled]: HD Audio device is unconditionally disabled.

■ **LAN i219LM Controller [Enabled]**

Enables or disables i219LM LAN Controller.

■ **Wake On LAN (i219) [Enabled]**

Enables or disables integrated LAN i219LM Wake on LAN function.

■ **LAN i210AT Controller [Enabled]**

Enables or disables I210 LAN Controller.

■ **Wake# event (PCIe) [Enabled]**

Enables or disables integrated LAN i210 Wake on LAN function.

■ **CN3 Function Switch [Mini-PCIe]**

Allows users to select [Mini-PCIe] or [mSATA] or [USB3.0] for CN3 connector.

■ **CN4 Function Switch [Mini-PCIe]**

Allows users to select [Mini-PCIe] or [mSATA] or [USB3.0] for CN4 connector.

■ **CN5 Function Switch [Mini-PCIe]**

Allows users to select [Mini-PCIe] or [mSATA] or [USB3.0] for CN5 connector.

■ **CN8 Function Switch [PCIe]**

Allows users to select [PCIe] or [SATA] for CN8 connector.

■ **BTB_FH2 Mode Selection [4x1]**

Allows users to select [4x1] or [1x4] for BTB_FH2 Mode.

■ **Amplifier Function [Enabled]**

Enables or disables Amplifier Function.

■ **Power Failure [Keep last state]**

Allows you to specify which power state system will enter when power is resumed after a power failure (G3 state).

[Always on]: Enters to power on state.

[Always off]: Enters to power off state.

[Keep last state]: Enters to the last power state before a power failure.

4.5 Security Setup

This section allows users to configure BIOS security settings.

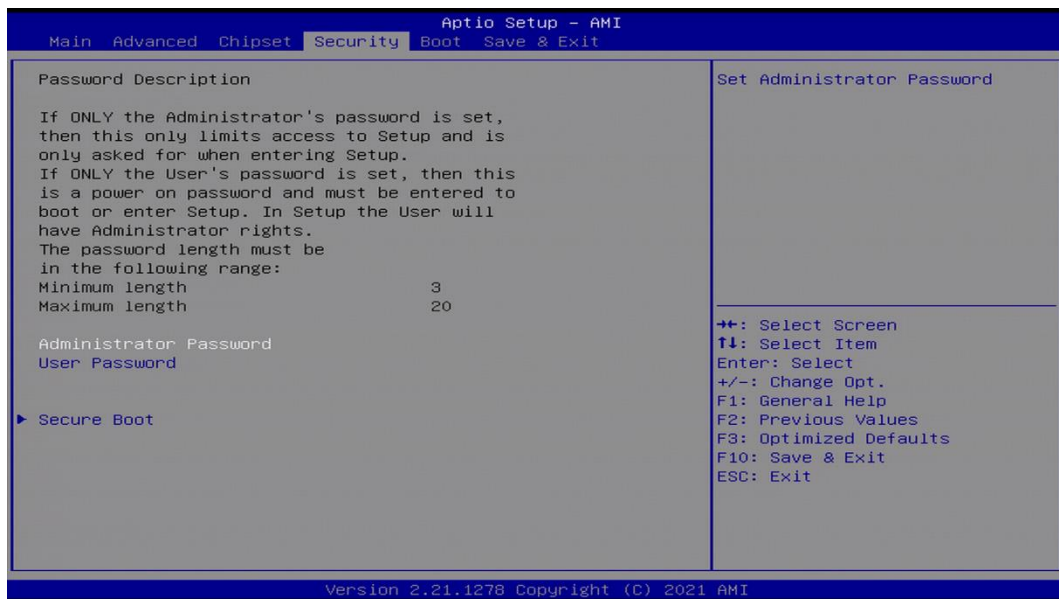

4.5.1 Administrator Password

Administrator Password controls access to the BIOS Setup utility.

4.5.2 User Password

User Password controls access to the system at boot and to the BIOS Setup utility.

4.5.3 Security Boot

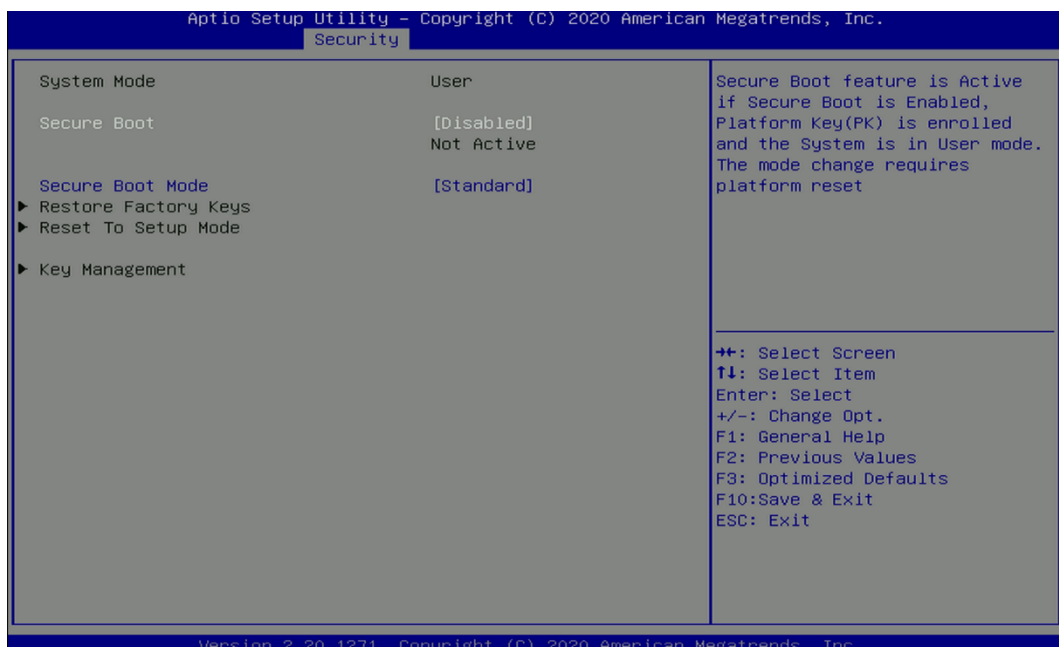

- Secure Boot [Disabled]**
Enable or disable Secure Boot function.
- Secure Boot Mode [Standard]**
Allows you to select Secure Boot Mode.
Configuration options: [Standard] [Custom].

4.6 Boot Setup

This section allows you to configure Boot settings.

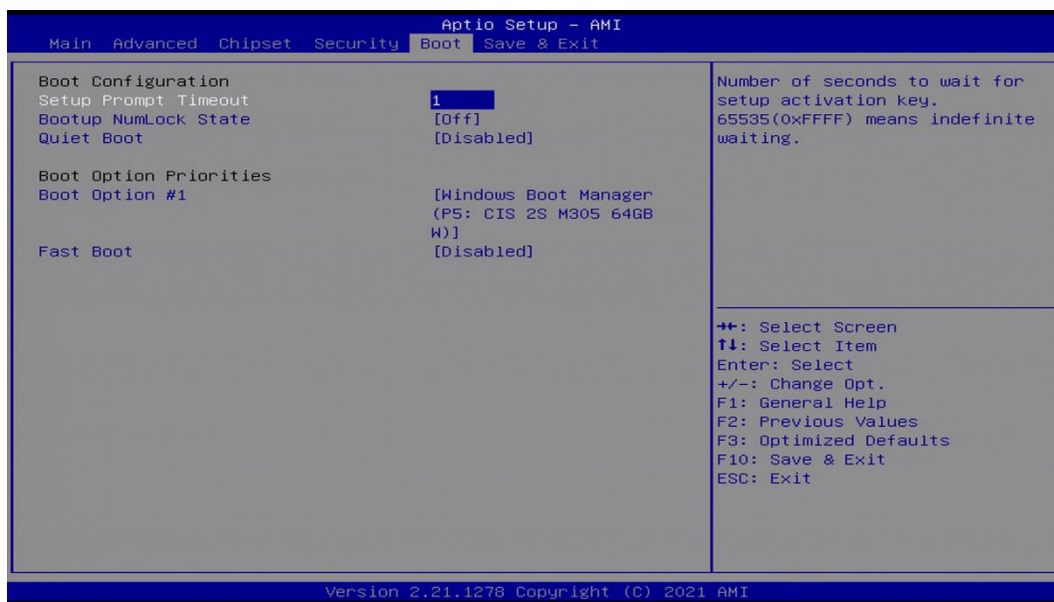

4.6.1 Setup Prompt Timeout [1]

Use this item to set number of seconds (1..65535) to wait for setup activation key.

4.6.2 Bootup NumLock State [Off]

Allows users to select the power-on state for keyboard NumLock.

4.6.3 Quiet Boot [Disabled]

Allows users to enable or disable Quiet Boot function.

4.6.4 Fast Boot [Disabled]

Allows users to enable or disable Fast Boot function.

4.7 Save & Exit

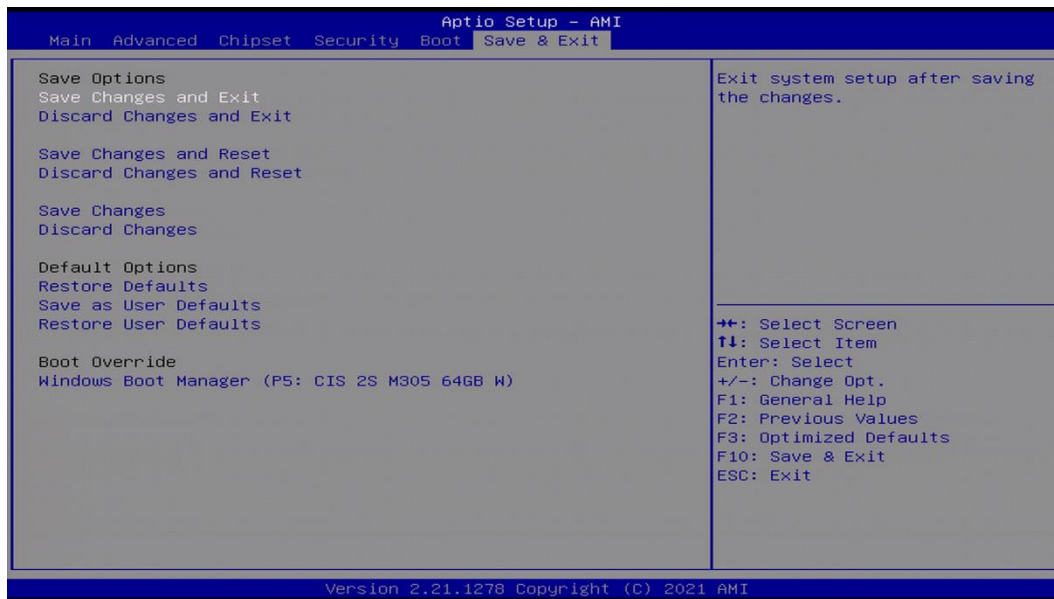

4.7.1 Save Changes and Exit

This item allows users to exit system setup after saving changes.

4.7.2 Discard Changes and Exit

This item allows users to exit system setup without saving changes.

4.7.3 Save Changes and Reset

This item allows users to reset the system after saving changes.

4.7.4 Discard Changes and Reset

This item allows users to reset system setup without saving any changes.

4.7.5 Save Changes

This item allows users to save changes done so far to any of the setup options.

4.7.6 Discard Changes

This item allows users to discard changes done so far to any of the setup options.

4.7.7 Restore Defaults

This item allows users to restore/ load default values for all the options.

4.7.8 Save as User Defaults

This item allows users to save the changes done so far as user defaults.

4.7.9 Restore User Defaults

This item allows users to restore the user defaults to all the options.



Chapter 5

Product Application

5.1 Digital I/O (DIO) application

This section describes DIO application of the product. The content and application development are better understood and implemented by well experienced professionals or developers.

5.1.1 Digital I/O Programming Guide

5.1.1.1 Pins for Digital I/O 1~8

Item	Standard	Item	Standard
GPIO70 (PIN 103)	DI	GPIO80 (PIN 111)	DO
GPIO71 (PIN 104)		GPIO81 (PIN 112)	
GPIO72 (PIN 105)		GPIO82 (PIN 113)	
GPIO73 (PIN 106)		GPIO83 (PIN 114)	
GPIO74 (PIN 107)		GPIO84 (PIN 115)	
GPIO75 (PIN 108)		GPIO85 (PIN 116)	
GPIO76 (PIN 109)		GPIO86 (PIN 117)	
GPIO77 (PIN 110)		GPIO87 (PIN 118)	

5.1.1.2 Pins for Digital I/O 9-16

Item	Standard	Item	Standard
GPIO30 (PIN 36)	DI	GPIO40 (PIN 44)	DO
GPIO31 (PIN 37)		GPIO41 (PIN 45)	
GPIO32 (PIN 38)		GPIO42 (PIN 46)	
GPIO33 (PIN 39)		GPIO43 (PIN 47)	
GPIO34 (PIN 40)		GPIO44 (PIN 48)	
GPIO35 (PIN 41)		GPIO45 (PIN 49)	
GPIO36 (PIN 42)		GPIO46 (PIN 50)	
GPIO37 (PIN 43)		GPIO47 (PIN 51)	

5.1.1.3 Programming Guide

To program the Super I/O chip F81866A configuration registers, the following configuration procedures must be followed in sequence:

- (1) Enter the Extended Function Mode
- (2) Configure the configuration registers
- (3) Exit the Extended Function Mode

The configuration register is used to control the behavior of the corresponding devices. To configure the register, use the index port to select the index and then write data port to alter the parameters. The default index port and data port are 0x4E and 0x4F, respectively.

Pull down the SOUT1 pin to change the default value to 0x2E/ 0x2F. To enable configuration, the entry key 0x87 must be written to the index port. To disable configuration, write exit entry key 0xAA to the index port.

Following is an example to enable configuration and to disable configuration by using debug.

- o 4e 87
- o 4e 87 (enable configuration)
- o 4e aa (disable configuration)

5.1.1.4 Relative Registers

To program the F81866A configuration registers, see the following configuration procedures.

Logic Device Number Register (LDN) — Index 07h

Bit	Name	R/W	Reset	Default	Description
7-0	LDN	R/W	LRESET#	00h	00h: Select FDC device configuration registers. 03h: Select Parallel Port device configuration registers. 04h: Select Hardware Monitor device configuration registers. 05h: Select KBC device configuration registers. 06h: Select GPIO device configuration registers. 07h: Select WDT device configuration registers. 0Ah: Select PME, ACPI and ERP device configuration registers. 10h: Select UART1 device configuration registers. 11h: Select UART2 device configuration registers. 12h: Select UART3 device configuration registers. 13h: Select UART4 device configuration registers. 14h: Select UART5 device configuration registers. 15h: Select UART6 device configuration registers. Otherwise: Reserved.

8.7.13.1 GPIO7 Output Enable Register — Index 80h

Bit	Name	R/W	Reset	Default	Description
7	GPIO77_OE	R/W	LRESET#	0	0: GPIO77 is in input mode. 1: GPIO77 is in output mode.
6	GPIO76_OE	R/W	LRESET#	0	0: GPIO76 is in input mode. 1: GPIO75 is in output mode.
5	GPIO75_OE	R/W	LRESET#	0	0: GPIO75 is in input mode. 1: GPIO75 is in output mode.
4	GPIO74_OE	R/W	LRESET#	0	0: GPIO74 is in input mode. 1: GPIO74 is in output mode.
3	GPIO73_OE	R/W	LRESET#	0	0: GPIO73 is in input mode. 1: GPIO73 is in output mode.
2	GPIO72_OE	R/W	LRESET#	0	0: GPIO72 is in input mode. 1: GPIO72 is in output mode.
1	GPIO71_OE	R/W	LRESET#	0	0: GPIO71 is in input mode. 1: GPIO71 is in output mode.
0	GPIO70_OE	R/W	LRESET#	0	0: GPIO70 is in input mode. 1: GPIO70 is in output mode.

8.7.13.3 GPIO7 Pin Status Register — Index 82h (This byte could be also read by base address + 3)

Bit	Name	R/W	Reset	Default	Description
7	GPIO77_IN	R	-	-	The pin status of GPIO77/STB#.
6	GPIO76_IN	R	-	-	The pin status of GPIO76/AFD#.
5	GPIO75_IN	R	-	-	The pin status of GPIO75/ERR#.
4	GPIO74_IN	R	-	-	The pin status of GPIO74/INIT#.
3	GPIO73_IN	R	-	-	The pin status of GPIO73/SLIN#.
2	GPIO72_IN	R	-	-	The pin status of GPIO72/ACK#.
1	GPIO71_IN	R	-	-	The pin status of GPIO71/BUSY.
0	GPIO70_IN	R	-	-	The pin status of GPIO70/PE/FANCTL3/PWM_DAC3.

8.7.9.1 GPIO3 Output Enable Register — Index C0h

Bit	Name	R/W	Reset	Default	Description
7	GPIO37_OE	R/W	LRESET#	0	0: GPIO37 is input. 1: GPIO37 is output.
6	GPIO36_OE	R/W	LRESET#	0	0: GPIO36 is input. 1: GPIO36 is output.
5	GPIO35_OE	R/W	LRESET#	0	0: GPIO35 is input. 1: GPIO35 is output.
4	GPIO34_OE	R/W	LRESET#	0	0: GPIO34 is input. 1: GPIO34 is output.
3	GPIO33_OE	R/W	LRESET#	0	0: GPIO33 is input. 1: GPIO33 is output.
2	GPIO32_OE	R/W	LRESET#	0	0: GPIO32 is input. 1: GPIO32 is output.
1	GPIO31_OE	R/W	LRESET#	0	0: GPIO31 is input. 1: GPIO31 is output.
0	GPIO30_OE	R/W	LRESET#	0	0: GPIO30 is input. 1: GPIO30 is output.

8.7.9.3 GPIO3 Pin Status Register — Index C2h (This byte could be also read by base address + 9 if GPIO_DEC_RANGE is set to "1")

Bit	Name	R/W	Reset	Default	Description
7	GPIO37_IN	R	-	-	The pin status of SIN3/GPIO37.
6	GPIO36_IN	R	-	-	The pin status of SOUT3/GPIO36.
5	GPIO35_IN	R	-	-	The pin status of DSR3#/GPIO35.
4	GPIO34_IN	R	-	-	The pin status of RTS3#/GPIO34.
3	GPIO33_IN	R	-	-	The pin status of DTR3#/GPIO33.
2	GPIO32_IN	R	-	-	The pin status of CTS3#/GPIO32.
1	GPIO31_IN	R	-	-	The pin status of RI3#/GPIO31.
0	GPIO30_IN	R	-	-	The pin status of DCD3#/GPIO30.

8.7.14.1GPIO8 Output Enable Register — Index 88h

Bit	Name	R/W	Reset	Default	Description
7	GPIO87_OE	R/W	LRESET#	1	0: GPIO87 is in input mode. 1: GPIO87 is in output mode.
6	GPIO86_OE	R/W	LRESET#	1	0: GPIO86 is in input mode. 1: GPIO86 is in output mode.
5	GPIO85_OE	R/W	LRESET#	1	0: GPIO85 is in input mode. 1: GPIO85 is in output mode.
4	GPIO84_OE	R/W	LRESET#	1	0: GPIO84 is in input mode. 1: GPIO84 is in output mode.
3	GPIO83_OE	R/W	LRESET#	1	0: GPIO83 is in input mode. 1: GPIO83 is in output mode.
2	GPIO82_OE	R/W	LRESET#	1	0: GPIO82 is in input mode. 1: GPIO82 is in output mode.
1	GPIO81_OE	R/W	LRESET#	1	0: GPIO81 is in input mode. 1: GPIO81 is in output mode.
0	GPIO80_OE	R/W	LRESET#	1	0: GPIO80 is in input mode. 1: GPIO80 is in output mode.

8.7.14.2GPIO8 Output Data Register — Index 89h (This byte could be also written by base address + 2)

Bit	Name	R/W	Reset	Default	Description
7	GPIO87_VAL	R/W	LRESET#	1	0: GPIO87 outputs 0 when in output mode. 1: GPIO87 outputs 1 when in output mode.
6	GPIO86_VAL	R/W	LRESET#	1	0: GPIO86 outputs 0 when in output mode. 1: GPIO86 outputs 1 when in output mode.
5	GPIO85_VAL	R/W	LRESET#	1	0: GPIO85 outputs 0 when in output mode. 1: GPIO85 outputs 1 when in output mode.
4	GPIO84_VAL	R/W	LRESET#	1	0: GPIO84 outputs 0 when in output mode. 1: GPIO84 outputs 1 when in output mode.
3	GPIO83_VAL	R/W	LRESET#	1	0: GPIO83 outputs 0 when in output mode. 1: GPIO83 outputs 1 when in output mode.
2	GPIO82_VAL	R/W	LRESET#	1	0: GPIO82 outputs 0 when in output mode. 1: GPIO82 outputs 1 when in output mode.
1	GPIO81_VAL	R/W	LRESET#	1	0: GPIO81 outputs 0 when in output mode. 1: GPIO81 outputs 1 when in output mode.
0	GPIO80_VAL	R/W	LRESET#	1	0: GPIO80 outputs 0 when in output mode. 1: GPIO80 outputs 1 when in output mode.

8.7.10.1GPIO4 Output Enable Register — Index B0h

Bit	Name	R/W	Reset	Default	Description
7	GPIO47_OE	R/W	LRESET#	1	0: GPIO47 is input. 1: GPIO47 is output.
6	GPIO46_OE	R/W	LRESET#	1	0: GPIO46 is input. 1: GPIO46 is output.
5	GPIO45_OE	R/W	LRESET#	1	0: GPIO45 is input. 1: GPIO45 is output.
4	GPIO44_OE	R/W	LRESET#	1	0: GPIO44 is input. 1: GPIO44 is output.
3	GPIO43_OE	R/W	LRESET#	1	0: GPIO43 is input. 1: GPIO43 is output.
2	GPIO42_OE	R/W	LRESET#	1	0: GPIO42 is input. 1: GPIO42 is output.
1	GPIO41_OE	R/W	LRESET#	1	0: GPIO41 is input. 1: GPIO41 is output.
0	GPIO40_OE	R/W	LRESET#	1	0: GPIO40 is input. 1: GPIO40 is output.

8.7.10.2 GPIO4 Output Data Register — Index B1h (This byte could be also written by base address + 10 if GPIO_DEC_RANGE is set to “1”)

Bit	Name	R/W	Reset	Default	Description
7	GPIO47_DATA	R/W	LRESET#	1	0: GPIO47 outputs 0 when in output mode. 1: GPIO47 outputs 1 when in output mode.
6	GPIO46_DATA	R/W	LRESET#	1	0: GPIO46 outputs 0 when in output mode. 1: GPIO46 outputs 1 when in output mode.
5	GPIO45_DATA	R/W	LRESET#	1	0: GPIO45 outputs 0 when in output mode. 1: GPIO45 outputs 1 when in output mode.
4	GPIO44_DATA	R/W	LRESET#	1	0: GPIO44 outputs 0 when in output mode. 1: GPIO44 outputs 1 when in output mode.
3	GPIO43_DATA	R/W	LRESET#	1	0: GPIO43 outputs 0 when in output mode. 1: GPIO43 outputs 1 when in output mode.
2	GPIO42_DATA	R/W	LRESET#	1	0: GPIO42 outputs 0 when in output mode. 1: GPIO42 outputs 1 when in output mode.
1	GPIO41_DATA	R/W	LRESET#	1	0: GPIO41 outputs 0 when in output mode. 1: GPIO41 outputs 1 when in output mode.
0	GPIO40_DATA	R/W	LRESET#	1	0: GPIO40 outputs 0 when in output mode. 1: GPIO40 outputs 1 when in output mode.

8.7.3 Base Address High Register — Index 60h

Bit	Name	R/W	Reset	Default	Description
7-0	GP_BASE_ADDR_HI	R/W	LRESET#	00h	The MSB of GPIO I/O port address.

8.7.3.4 Base Address Low Register — Index 61h

Bit	Name	R/W	Reset	Default	Description
7-0	BASE_ADDR_LO	R/W	LRESET#	00h	<p>The LSB of KBC data port address. When GPIO_DEC_RANGE is “0”, only 8 bytes are decoded: Base + 0: index port. Base + 1: data port. Base + 2: GPIO8 data register. Base + 3: GPIO7 data register. Base + 4: GPIO6 data register. Base + 5: GPIO5 data register. Base + 6: GPIO0 data register. Base + 7: GPIO1 data register.</p> <p>If GPIO_DEC_RANGE is set to “1”, more 8 bytes are decoded: Base + 8: GPIO2 data register. Base + 9: GPIO3 data register. Base + 10: GPIO4 data register.</p> <p>Otherwise: Reserved.</p> <p>There are three ways to access the GPIO registers.</p> <ol style="list-style-type: none"> 1. Use configuration register port 0x4E/0x4F (or 0x2E/0x2F), the LDN for GPIO is 0x06. 2. Use GPIO index/data port. Write index to index port first and then read/write the register. 3. Use digital I/O port. The way only access GPIO data register. Write data to this port will control the data output register. And read this port will read the pin status register.

5.1.1.5 Sample Code in C Language

5.1.1.5.1 Control of GP70 to GP77 (DI1 ~ DI8)

```
#define AddrPort 0x4E
```

```
#define DataPort 0x4F
```

<Enter the Extended Function Mode>

```
WriteByte(AddrPort, 0x87)
```

```
WriteByte(AddrPort, 0x87)           // Must write twice to enter Extended mode
```

<Select Logic Device>

```
WriteByte(AddrPort, 0x07)
```

```
WriteByte(dataPort, 0x06)           // Select logic device 06h
```

<Output/Input Mode Selection> // Set GP70 to GP77 input Mode

```
WriteByte(AddrPort, 0x80)           // Select configuration register 80h
```

```
WriteByte(DataPort, 0x0X)           // Set (bit 0~7) = 0 to select GP 70~77 as Input mode.
```

<Input Value>

```
WriteByte(AddrPort, 0x82)           // Select configuration register 82h
```

```
ReadByte(DataPort, Value)           // Read bit 0~7 (0xFx)= GP70 ~77 as High.
```

<Leave the Extended Function Mode>

```
WriteByte(AddrPort, 0xAA)
```

5.1.1.5.2 Control of GP80 to GP87 (DO1 ~ DO8)

```
#define AddrPort 0x4E
```

```
#define DataPort 0x4F
```

<Enter the Extended Function Mode>

```
WriteByte(AddrPort, 0x87)
```

```
WriteByte(AddrPort, 0x87) // Must write twice to enter Extended mode
```

<Select Logic Device>

```
WriteByte(AddrPort, 0x07)
```

```
WriteByte(DataPort, 0x06) // Select logic device 06h
```

<Output/Input Mode Selection> // Set GP80 to GP87 output Mode

```
WriteByte(AddrPort, 0x88) // Select configuration register 88h
```

```
WriteByte(DataPort, 0xFF) // Set (bit 0~7) = 1 to select GP 80 ~87 as Output mode.
```

<Output Value>

```
WriteByte(AddrPort, 0x89) // Select configuration register 89h
```

```
WriteByte(DataPort, Value) // Set bit 0~7=(0/1) to output GP 80~87 as Low or High
```

<Leave the Extended Function Mode>

```
WriteByte(AddrPort, 0xAA)
```

5.1.1.5.3 Control of GP70 to GP77 & GP30 to GP37 (DI1 ~ DI16)

```
#define AddrPort 0x4E
```

```
#define DataPort 0x4F
```

<Enter the Extended Function Mode>

```
WriteByte(AddrPort, 0x87)
```

```
WriteByte(AddrPort, 0x87) // Must write twice to entering Extended mode
```

<Select Logic Device>

```
WriteByte(AddrPort, 0x07)
```

```
WriteByte(dataPort, 0x06) // Select logic device 06h
```

```
<Input Mode Selection>           // Set GP70 to GP77 input Mode
WriteByte(AddrPort, 0x80)         // Select configuration register 80h
WriteByte(DataPort, 0x0X)        // Set (bit 0~7) = 0 to select GP 70~77 as Input mode
```

```
<Input Mode Selection>           // Set GP30 to GP37 input Mode
WriteByte(AddrPort, 0xC0)        // Select configuration register C0h
WriteByte(DataPort, 0x0X)        // Set (bit 0~7) = 0 to select GP 30~37 as Input mode
```

```
<input Value>
WriteByte(AddrPort, 0x82)        // Select configuration register 82h
ReadByte(DataPort, Value)        // Read bit 0~7(0xFx)= GP70~77 as High
```

```
<input Value>
WriteByte(AddrPort, 0xC2)        // Select configuration register C2h
ReadByte(DataPort, Value)        // Read bit 0~7(0xFx)= GP30~37 as High
```

```
<Leave the Extended Function Mode>
WriteByte(AddrPort, 0xAA)
```

5.1.1.5.4 Control of GP80 to GP87 & GP40 to GP47 (DO1 ~ DO16)

```
#define AddrPort 0x4E
```

```
#define DataPort 0x4F
```

<Enter the Extended Function Mode>

```
WriteByte(AddrPort, 0x87)
```

```
WriteByte(AddrPort, 0x87) // Must write twice to entering Extended mode
```

<Select Logic Device>

```
WriteByte(AddrPort, 0x07)
```

```
WriteByte(DataPort, 0x06) // Select logic device 06h
```

<Output Mode Selection> // Set GP80 to GP87 output Mode

```
WriteByte(AddrPort, 0x88) // Select configuration register 88h
```

```
WriteByte(DataPort, (0xFF)) // Set (bit 0~7) = 1 to select GP 80~87 as Output mode
```

<Output Mode Selection> // Set GP40 to GP47 output Mode

```
WriteByte(AddrPort, 0xB0) // Select configuration register B0h
```

```
WriteByte(DataPort, (0xFF)) // Set (bit 0~7) = 1 to select GP 40~47 as Output mode
```

<Output Value>

```
WriteByte(AddrPort, 0x89) // Select configuration register 89h
```

```
WriteByte(DataPort, Value) // Set bit 0~7=(0/1) to output GP 80~87 as Low or High
```

<Output Value>

```
WriteByte(AddrPort, 0xB1) // Select configuration register B1h
```

```
WriteByte(DataPort, Value) // Set bit 0~7=(0/1) to output GP 40~47 as Low or High
```

<Leave the Extended Function Mode>

```
WriteByte(AddrPort, 0xAA)
```

5.1.1.6 Change base address

<Enter the Extended Function Mode>

```
WriteByte(AddrPort, 0x87)
```

```
WriteByte(AddrPort, 0x87) // Must write twice to enter Extended mode
```

<Select Logic Device>

```
WriteByte(AddrPort, 0x07)
```

```
WriteByte(dataPort, 0x06) // Select logic device 06h
```

```
WriteByte(AddrPort, 0x60) // Select configuration register 60h (High Byte address)
```

```
WriteByte(DataPort, (0x0A))
```

```
WriteByte(AddrPort, 0x61) // Select configuration register 61h (Low Byte address)
```

```
WriteByte(DataPort, (0x00))
```

<Leave the Extended Function Mode>

```
WriteByte(AddrPort, 0xAA)
```

Cincoze default GPIO Port base address is 0xA00h

5.1.1.7 DATA Bit Table (DIO)

7	6	5	4	3	2	1	0	bit
0	0	0	0	0	0	0	1	Value
1								/h

= DI1

(Base address
+3) (0xA03)

7	6	5	4	3	2	1	0	bit
0	0	0	0	0	0	0	1	Value
1								/h

= DO1

(Base address
+2) (0xA02)

7	6	5	4	3	2	1	0	bit
0	0	0	0	0	0	1	0	Value
2								/h

= DI2

(Base address
+3) (0xA03)

7	6	5	4	3	2	1	0	bit
0	0	0	0	0	0	1	0	Value
2								/h

= DO2

Base address
+2) (0xA02)

7	6	5	4	3	2	1	0	bit
0	0	0	0	0	1	0	0	Value
4								/h

= DI3

(Base address
+3) (0xA03)

7	6	5	4	3	2	1	0	bit
0	0	0	0	0	1	0	0	Value
4								/h

= DO3

Base address
+2) (0xA02)

7	6	5	4	3	2	1	0	bit
0	0	0	0	1	0	0	0	Value
8								/h

= DI4

(Base address
+3) (0xA03)

7	6	5	4	3	2	1	0	bit
0	0	0	0	1	0	0	0	Value
8								/h

= DO4

Base address
+2) (0xA02)

7	6	5	4	3	2	1	0	bit
0	0	0	1	0	0	0	0	Value
10								/h

= DI5

(Base address
+3) (0xA03)

7	6	5	4	3	2	1	0	bit
0	0	0	1	0	0	0	0	Value
10								/h

= DO5

Base address
+2) (0xA02)

7	6	5	4	3	2	1	0	bit
0	0	1	0	0	0	0	0	Value
20								/h

= DI6

(Base address
+3) (0xA03)

7	6	5	4	3	2	1	0	bit
0	0	1	0	0	0	0	0	Value
20								/h

= DO6

Base address
+2) (0xA02)

7	6	5	4	3	2	1	0	bit
0	1	0	0	0	0	0	0	Value
40								/h

= DI7

(Base address
+3) (0xA03)

7	6	5	4	3	2	1	0	bit
0	1	0	0	0	0	0	0	Value
40								/h

= DO7

Base address
+2) (0xA02)

7	6	5	4	3	2	1	0	bit
1	0	0	0	0	0	0	0	Value
80								/h

= DI8

(Base address
+3) (0xA03)

7	6	5	4	3	2	1	0	bit
1	0	0	0	0	0	0	0	Value
80								/h

= DO8

Base address
+2) (0xA02)

7	6	5	4	3	2	1	0	bit
0	0	0	0	0	0	0	1	Value
1								/h

= **DI9**
 (Base address
 +9) (0xA09)

7	6	5	4	3	2	1	0	bit
0	0	0	0	0	0	0	1	Value
1								/h

= **DO9**
 (Base address
 +10) (0xA10)

7	6	5	4	3	2	1	0	bit
0	0	0	0	0	0	1	0	Value
2								/h

= **DI10**
 (Base address
 +9) (0xA09)

7	6	5	4	3	2	1	0	bit
0	0	0	0	0	0	1	0	Value
2								/h

= **DO10**
 Base address
 +10) (0xA10)

7	6	5	4	3	2	1	0	bit
0	0	0	0	0	1	0	0	Value
4								/h

= **DI11**
 (Base address
 +9) (0xA09)

7	6	5	4	3	2	1	0	bit
0	0	0	0	0	1	0	0	Value
4								/h

= **DO11**
 Base address
 +10) (0xA10)

7	6	5	4	3	2	1	0	bit
0	0	0	0	1	0	0	0	Value
8								/h

= **DI12**
 (Base address
 +9) (0xA09)

7	6	5	4	3	2	1	0	bit
0	0	0	0	1	0	0	0	Value
8								/h

= **DO12**
 Base address
 +10) (0xA10)

7	6	5	4	3	2	1	0	bit
0	0	0	1	0	0	0	0	Value
10								/h

= **DI13**
 (Base address
 +9) (0xA09)

7	6	5	4	3	2	1	0	bit
0	0	0	1	0	0	0	0	Value
10								/h

= **DO13**
 Base address
 +10) (0xA10)

7	6	5	4	3	2	1	0	bit
0	0	1	0	0	0	0	0	Value
20								/h

= **DI14**
 (Base address
 +9) (0xA09)

7	6	5	4	3	2	1	0	bit
0	0	1	0	0	0	0	0	Value
20								/h

= **DO14**
 Base address
 +10) (0xA10)

7	6	5	4	3	2	1	0	bit
0	1	0	0	0	0	0	0	Value
40								/h

= **DI15**
 (Base address
 +9) (0xA09)

7	6	5	4	3	2	1	0	bit
0	1	0	0	0	0	0	0	Value
40								/h

= **DO15**
 Base address
 +10) (0xA10)

7	6	5	4	3	2	1	0	bit
1	0	0	0	0	0	0	0	Value
80								/h

= **DI16**
 (Base address
 +9) (0xA09)

7	6	5	4	3	2	1	0	bit
1	0	0	0	0	0	0	0	Value
80								/h

= **DO16**
 Base address
 +10) (0xA10)

5.1.1.8 DIO I/O Port Address (Default Address 0xA00)

Pin Definition	DI8	DI7	DI6	DI5	DI4	DI3	DI2	DI1
Data Bits	7	6	5	4	3	2	1	0
DIO	Digital Input							
I/O Port Address	0xA03							

Pin Definition	DO8	DO7	DO6	DO5	DO4	DO3	DO2	DO1
Data Bits	7	6	5	4	3	2	1	0
DIO	Digital Output							
I/O Port Address	0xA02							

Pin Definition	DI16	DI15	DI14	DI13	DI12	DI11	DI10	DI9
Data Bits	7	6	5	4	3	2	1	0
DIO	Digital Input							
I/O Port Address	0xA09							

Pin Definition	DO16	DO15	DO14	DO13	DO12	DO11	DO10	DO9
Data Bits	7	6	5	4	3	2	1	0
DIO	Digital Output							
I/O Port Address	0xA010							

5.2 DIO Hardware Specification

- XCOM+/ 2XCOM+: Isolated power in V+
- XCOM-/ 2XCOM-: Isolated power in V-
- Isolated power in DC voltage: 9-30V
- 8x / 16x Digital Input (Source Type)
- Input Signal Voltage Level
 - Signal Logic 0: XCOM+ = 9V, $\text{Signal Low} - \underline{V-} < 1V$
 $\text{XCOM+} > 9V, \quad \underline{V+} - \text{Signal Low} > 8V$
 - Signal Logic 1: $> \underline{\text{XCOM+}} - \underline{3V}$
- Input Driving Sink Current:
 - Minimal: 1 mA
 - Normal: 5 mA
- 8x / 16x Digital Output (Open Drain)
 - DO Signal have to pull up resistor to XCOM+ for external device, the resistance will affect the pull up current
 - Signal High Level: Pull up resistor to XCOM+
 - Signal Low Level: = XCOM-
 - Sink Current: 1A (Max)

5.2.1 DIO Connector Definition



DIO1: Digital Input / Output Connector

Connector Type: Terminal Block 2X5 10-pin, 3.5mm pitch

Pin	Definition	Pin	Definition
1	DI1	11	DO1
2	DI2	12	DO2
3	DI3	13	DO3
4	DI4	14	DO4
5	XCOM+ (DC INPUT)	15	XCOM- (GND)

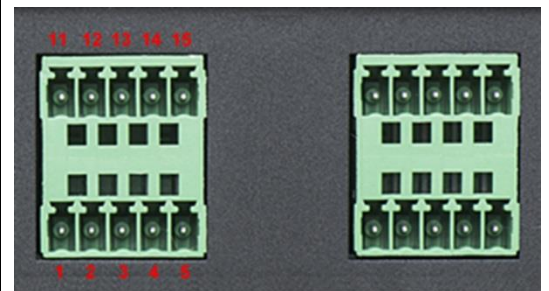

Pin	Definition	Pin	Definition
6	DI5	16	DO5
7	DI6	17	DO6
8	DI7	18	DO7
9	DI8	19	DO8
10	2XCOM+ (DC INPUT)	20	2XCOM- (GND)

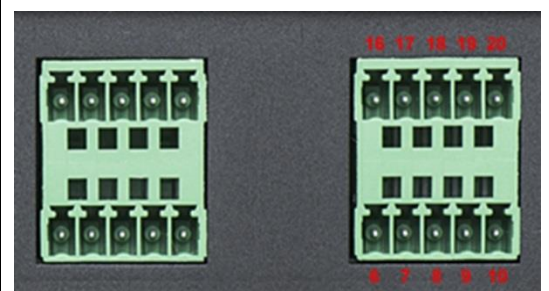

Reference Input Circuit

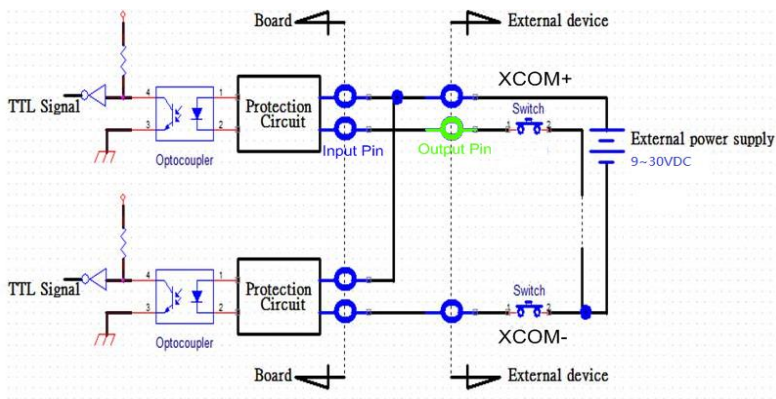

Digital Input Wiring

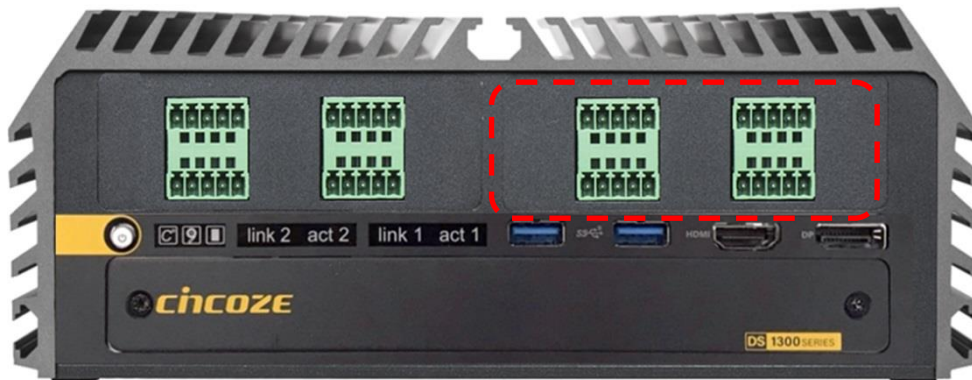
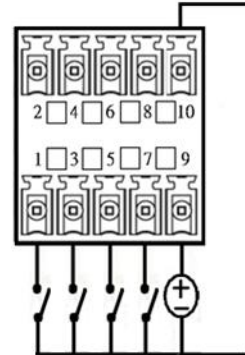

DIO2: Digital Input / Output Connector

Connector Type: Terminal Block 2X5 10-pin, 3.5mm pitch

Pin	Definition	Pin	Definition
1	DI1 (DI9)	11	DO1 (DO9)
2	DI2 (DI10)	12	DO2 (DO10)
3	DI3 (DI11)	13	DO3 (DO11)
4	DI4 (DI12)	14	DO4 (DO12)
5	XCOM+ (DC INPUT)	15	XCOM- (GND)

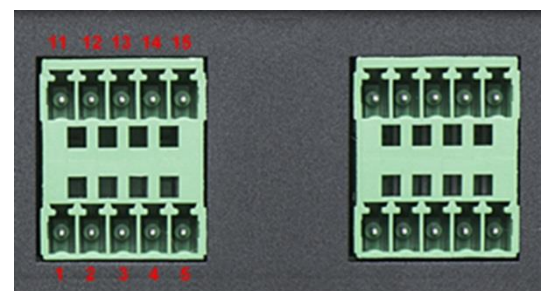

Pin	Definition	Pin	Definition
6	DI5 (DI13)	16	DO5 (DO13)
7	DI6 (DI14)	17	DO6 (DO14)
8	DI7 (DI15)	18	DO7 (DO15)
9	DI8 (DI16)	19	DO8 (DO16)
10	2XCOM+ (DC INPUT)	20	2XCOM- (GND)

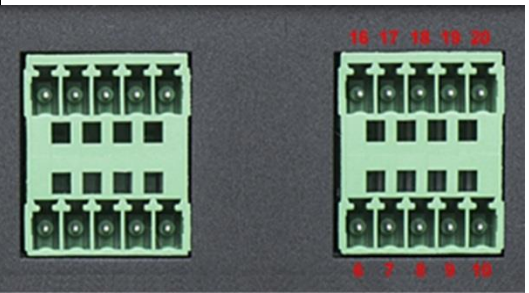

Reference Output Circuit

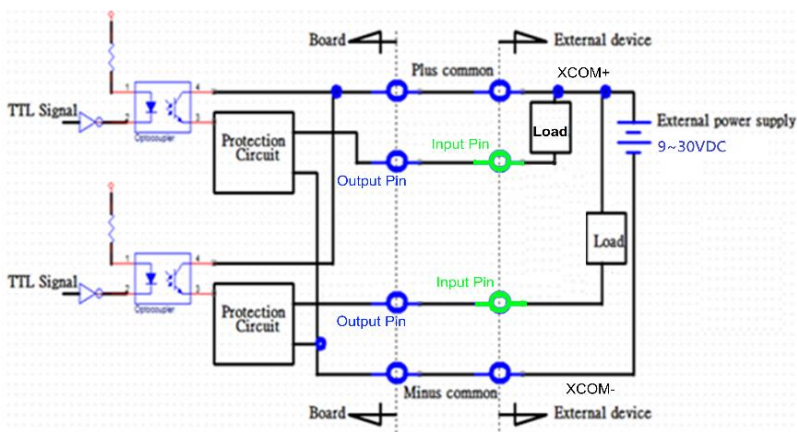

Digital Output Wiring

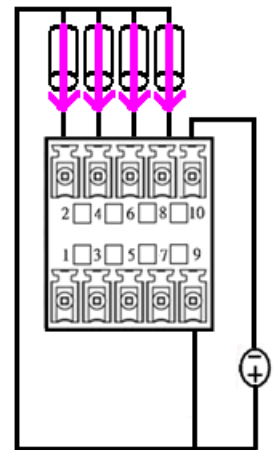

5.3 GPIO LED application

This section describes GPIO LED application of the product. The content and application development are better understood and implemented by well experienced professionals or developers.

5.3.1 GPIO LED Programming Guide

5.3.1.1 Pins for GPIO LED

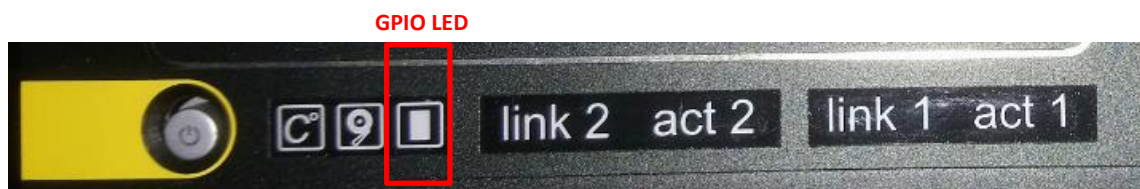

Item	GPIO LED
GPIO 10	LED ON/OFF

5.3.1.2 Programming Guide

To program the Super I/O chip F81866A configuration registers, the following configuration procedures must be followed in sequence:

- (1) Enter the Extended Function Mode
- (2) Configure the configuration registers
- (3) Exit the Extended Function Mode

The configuration register is used to control the behavior of the corresponding devices. To configure the register, use the index port to select the index and then write data port to alter the parameters. The default index port and data port are 0x4E and 0x4F, respectively.

Pull down the SOUT1 pin to change the default value to 0x2E/ 0x2F. To enable configuration, the entry key 0x87 must be written to the index port. To disable configuration, write exit entry key 0xAA to the index port.

Following is examples to enable configuration and to disable configuration by using debug.

Example to enable configuration:

```
-o 4e 87
```

```
-o 4e 87
```

Example to disable configuration:

```
-o 4e aa
```

5.3.1.3 Relative Registers

To program the F81866A configuration registers, see the following configuration procedures.

Logic Device Number Register (LDN) — Index 07h

Bit	Name	R/W	Reset	Default	Description
7-0	LDN	R/W	LRESET#	00h	00h: Select FDC device configuration registers. 03h: Select Parallel Port device configuration registers. 04h: Select Hardware Monitor device configuration registers. 05h: Select KBC device configuration registers. 06h: Select GPIO device configuration registers. 07h: Select WDT device configuration registers. 0Ah: Select PME, ACPI and ERP device configuration registers. 10h: Select UART1 device configuration registers. 11h: Select UART2 device configuration registers. 12h: Select UART3 device configuration registers. 13h: Select UART4 device configuration registers. 14h: Select UART5 device configuration registers. 15h: Select UART6 device configuration registers. Otherwise: Reserved.

Following is an example to Select GPIO device by LDN(index 07h) using debug.

-o 4e 07

-o 4f 06

Relative Registers for GPIO LED (GPIO10)

GPIO1 Output Enable Register — Index E0h					
Bit	Name	R/W	Reset	Default	Description
7	GPIO17_OE	R/W	5VSB	0	0: GPIO17 is in input mode. 1: GPIO17 is in output mode.
6	GPIO16_OE	R/W	5VSB	0	0: GPIO16 is in input mode. 1: GPIO16 is in output mode.
5	GPIO15_OE	R/W	5VSB	0	0: GPIO15 is in input mode. 1: GPIO15 is in output mode.
4	GPIO14_OE	R/W	5VSB	0	0: GPIO14 is in input mode. 1: GPIO14 is in output mode.
3	GPIO13_OE	R/W	5VSB	0	0: GPIO13 is in input mode. 1: GPIO13 is in output mode.
2	GPIO12_OE	R/W	5VSB	0	0: GPIO12 is in input mode. 1: GPIO12 is in output mode.
1	GPIO11_OE	R/W	5VSB	0	0: GPIO11 is in input mode. 1: GPIO11 is in output mode.
0	GPIO10_OE	R/W	5VSB	0	0: GPIO10 is in input mode. 1: GPIO10 is in output mode.

Following example to set output enable for GPIO10 (LED ON/OFF) by using debug.

First step, read the original value from output enable register (index E0)

-o 4e e0

-l 4f

00 (Note: This is for example, we pretend to get original value is 00)

Because we need to set bit0 to 1 for GPIO10 output , thus made the new value to 01 .

Second step,write the new value 01 to set bit0 with output mode

-o 4e e0

-o 4f 01

GPIO1 Output Data Register — Index E1h (This byte could be also written by base address + 7)

Bit	Name	R/W	Reset	Default	Description
7	GPIO17_VAL	R/W	5VSB	1	0: GPIO17 outputs 0 when in output mode. 1: GPIO17 outputs1 when in output mode.
6	GPIO16_VAL	R/W	5VSB	1	0: GPIO16 outputs 0 when in output mode. 1: GPIO16 outputs1 when in output mode.
5	GPIO15_VAL	R/W	5VSB	1	0: GPIO15 outputs 0 when in output mode. 1: GPIO15 outputs 1 when in output mode.
4	GPIO14_VAL	R/W	5VSB	1	0: GPIO14 outputs 0 when in output mode. 1: GPIO14 outputs 1 when in output mode.
3	GPIO13_VAL	R/W	5VSB	1	0: GPIO13 outputs 0 when in output mode. 1: GPIO13 outputs 1 when in output mode.
2	GPIO12_VAL	R/W	5VSB	1	0: GPIO12 outputs 0 when in output mode. 1: GPIO12 outputs 1 when in output mode.
1	GPIO11_VAL	R/W	5VSB	1	0: GPIO11 outputs 0 when in output mode. 1: GPIO11 outputs 1 when in output mode.
0	GPIO10_VAL	R/W	5VSB	1	0: GPIO10 outputs 0 when in output mode. 1: GPIO10 outputs 1 when in output mode.

Following example to set output data for GPIO10 (LED ON/OFF) by using debug.

First step, read the original value from output enable register (index E1)

```
-o 4e e1
```

```
-l 4f
```

```
00 (Note: This is for example, we pretend to get original value is 00 )
```

Because we need to set bit0 to 1 for GPIO10 output data , thus made the new value to 01 .

Second step: write the new value 01 to set bit0 for control output

```
-o 4e e1
```

```
-o 4f 01 ( Note, the bit0 (GPIO10) can be set 0 or 1 )
```

5.3.1.4 Sample Code in C Language

Control of GPIO10 (GPIO LED ON/OFF)

```
#define AddrPort 0x4E
#define DataPort 0x4F

<Enter the Extended Function Mode>
WriteByte(AddrPort, 0x87)
WriteByte(AddrPort, 0x87)           // Must write twice to enter Extended mode

<Select Logic Device>
WriteByte(AddrPort, 0x07)
WriteByte(DataPort, 0x06)         // Select logic device 06h

<Output/Input Mode Selection>     // Set GPIO10 to output Mode
WriteByte(AddrPort, 0xE0)         // Select configuration register E0h
Value=ReadByte(DataPort)         //Read Original Value from register E0h
WriteByte(AddrPort, 0xE0)         // Select configuration register E0h
WriteByte(DataPort, Value | 0x01) // Set (bit 0) = 1 to select GPIO10 as output mode

<Output Value>

WriteByte(AddrPort, 0xE1)         // Select configuration register E1h
Value=ReadByte(DataPort)         //Read Original Value from register E1h

WriteByte(AddrPort, 0xE1)         // Select configuration register E1h
WriteByte(DataPort, Value & 0xFE) // Set (bit 0) =0 to output GPIO10 as Low

WriteByte(AddrPort, 0xE1)         // Select configuration register E1h
WriteByte(DataPort, Value | 0x01) // Set (bit 0) =1 to output GPIO10 as High

<Leave the Extended Function Mode>
WriteByte(AddrPort, 0xAA)
```

5.3.1.5 Change base address

Cincoze default GPIO Port base address is 0xA00

Base Address High Register — Index 60h

Bit	Name	R/W	Reset	Default	Description
7-0	GP_BASE_ADDR_HI	R/W	LRESET#	00h	The MSB of GPIO I/O port address.

Base Address Low Register — Index 61h

Bit	Name	R/W	Reset	Default	Description
7-0	BASE_ADDR_LO	R/W	LRESET#	00h	<p>The LSB of KBC data port address. When GPIO_DEC_RANGE is "0", only 8 bytes are decoded:</p> <p>Base + 0: index port. Base + 1: data port. Base + 2: GPIO8 data register. Base + 3: GPIO7 data register. Base + 4: GPIO6 data register. Base + 5: GPIO5 data register. Base + 6: GPIO0 data register. Base + 7: GPIO1 data register.</p> <p>If GPIO_DEC_RANGE is set to "1", more 8 bytes are decoded:</p> <p>Base + 8: GPIO2 data register. Base + 9: GPIO3 data register. Base + 10: GPIO4 data register.</p> <p>Otherwise: Reserved.</p> <p>There are three ways to access the GPIO registers.</p> <ol style="list-style-type: none"> 1. Use configuration register port 0x4E/0x4F (or 0x2E/0x2F), the LDN for GPIO is 0x06. 2. Use GPIO index/data port. Write index to index port first and then read/write the register. 3. Use digital I/O port. The way only access GPIO data register. Write data to this port will control the data output register. And read this port will read the pin status register.

<Enter the Extended Function Mode>

```
WriteByte(AddrPort, 0x87)
```

```
WriteByte(AddrPort, 0x87) // Must write twice to enter Extended mode
```

<Select Logic Device>

```
WriteByte(AddrPort, 0x07)
```

```
WriteByte(dataPort, 0x06) // Select logic device 06h
```

```
WriteByte(AddrPort, 0x60)
```

```
// Select configuration register 60h (High Byte address)
```

```
WriteByte(DataPort, (0x0A))
```

```
WriteByte(AddrPort, 0x61) // Select configuration register 61h (Low Byte address)
WriteByte(DataPort, (0x00))
```

<Leave the Extended Function Mode>

```
WriteByte(AddrPort, 0xAA)
```

5.3.1.6 DATA Bit Table

GPIO-LED LED ON/OFF (GPIO10)



I/O Port data register address = Base address + 7 = 0xA07

7	6	5	4	3	2	1	0	bit	
0	0	0	0	0	0	0	1	Value	= LED (Base address +7)
1								/h	(0xA07)

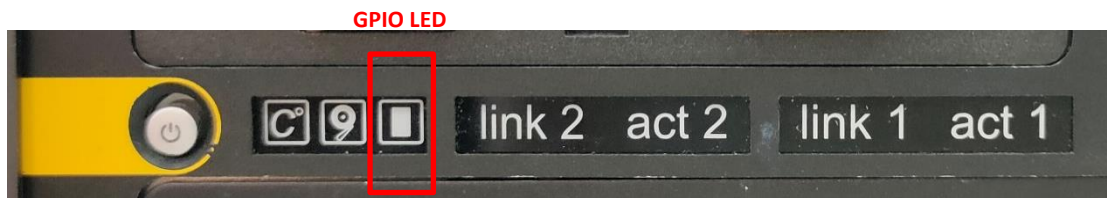
5.4 GPIO LED Status Definition



LED Type	Status	LED Color
GPIO LED	GPIO activity	Green
	No activity	Off



Chapter 6

Optional Modules & Accessories

6.1 Optional Module Pin Definition & Settings

6.1.1 CMI-2P5GLAN03/ UB1012 Module

LAN (I225) LED Status Definition

Link Speed LED Status	Definition
Steady Green	2.5 Gbps Network Link
Steady Orange	1 Gbps Network Link
Off	100 Mbps Network Link
Off	10 Mbps Network Link
Link Act LED Status	Definition
Blinking Yellow	Link and Data Activity
Steady Yellow	Link but No Activity

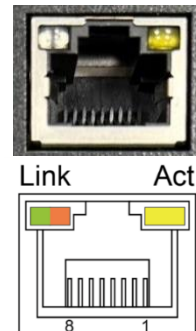

6.1.2 CMI-10GXM12LAN03/ UB1037 Module

LAN (X550) LED Status Definition

Link Speed LED Status	Definition
Steady Green	10 Gbps Network Link
Steady Orange	1 Gbps Network Link
Off	100 Mbps Network Link
Link Act LED Status	Definition
Blinking Yellow	Link and Data Activity
Steady Yellow	Link but No Activity



LAN Port Pin Definitions

Connector Type: M12 X coded 8pin connector

Pin	Definition	Pin	Definition
1	MDX0+	2	MDX0-
3	MDX1+	4	MDX1-
5	MDX3+	6	MDX3-
7	MDX2-	8	MDX2+
9	GND		

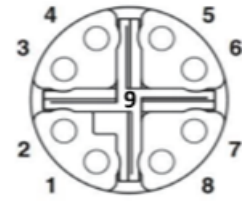

6.1.3 CMI-M12LAN01-R12/UB1010 Module

CMI-M12 LAN Module Pin Definitions

Connector Type: M12 A coded 8pin connector

Pin	Definition	Pin	Definition
1	2_LAN1_0+	2	2_LAN1_0-
3	2_LAN1_1+	4	2_LAN1_2+
5	2_LAN1_2-	6	2_LAN1_1-
7	2_LAN1_3+	8	2_LAN1_3-

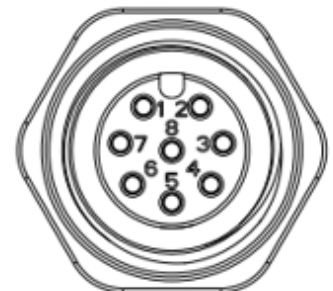

6.1.4 CMI-XM12LAN01-R12/UB1030 Module

CMI-XM12LAN01 Module Pin Definitions

Connector Type: M12 X coded 8pin connector

Pin	Definition	Pin	Definition
1	D1+	2	D1-
3	D2+	4	D2-
5	D4+	6	D4-
7	D3-	8	D3+

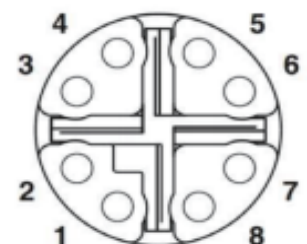

6.1.5 CMI-CAN01-R10/UB1038 Module

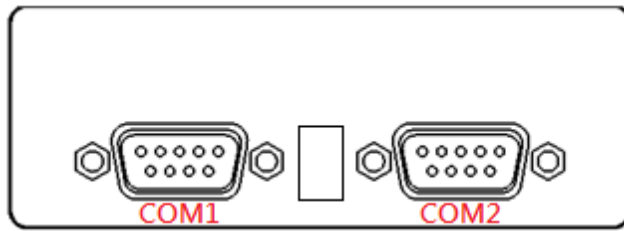

COM1 and COM2 (on the module) : CAN BUS Connector

Connector Type: 9-pin D-Sub

Pin	CAN BUS1 Definition	CAN BUS2 Definition
1	N.C	N.C
2	CAN1L	CAN2L
3	GND	GND
4	N.C	N.C
5	N.C	N.C
6	GND	GND
7	CAN1H	CAN2H
8	N.C	N.C
9	N.C	N.C



SW1: COM1/COM2 120Ω Terminating Resistor Select

Location	Function		DIP1	DIP2
SW1 on CMI-CAN Module	COM1	Enabled	OFF (Default)	OFF (Default)
		Disabled	ON	ON



Location	Function		DIP1	DIP2
SW1 on CMI-CAN Module	COM2	Enabled	OFF (Default)	OFF (Default)
		Disabled	ON	ON



6.1.6 CMI-COM02/UB1004 Module

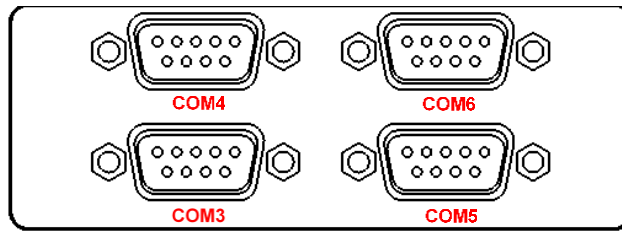

COM3~COM6 : RS232 / RS422 / RS485 Connector

Connector Type: 9-pin D-Sub

Pin	RS232 Definition	RS422 / 485 Full Duplex Definition	RS485 Half Duplex Definition
1	DCD	TX-	DATA -
2	RXD	TX+	DATA +
3	TXD	RX+	
4	DTR	RX-	
5	GND		
6	DSR		
7	RTS		
8	CTS		
9	RI		



SW1 on CMI-COM02 Module : COM3~COM6 Power Select

Dip	Function	Definition	
1-2	COM6	0V(RI)	ON/ON (Default)
		5V	ON/OFF
		12V	OFF/OFF
3-4	COM5	0V(RI)	ON/ON (Default)
		5V	ON/OFF
		12V	OFF/OFF
5-6	COM4	0V(RI)	ON/ON (Default)
		5V	ON/OFF
		12V	OFF/OFF
7-8	COM3	0V(RI)	ON/ON (Default)
		5V	ON/OFF
		12V	OFF/OFF

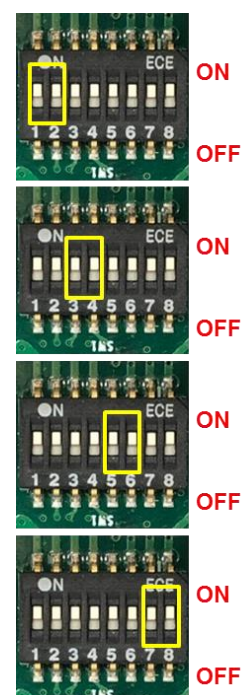

6.1.7 CMI-ICOM01/UB1004 Module

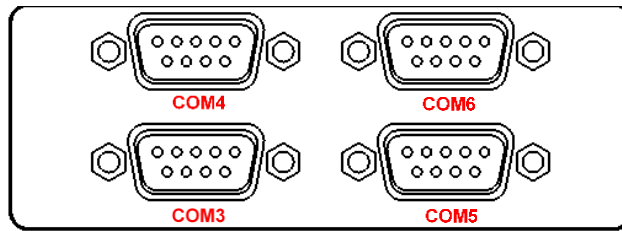

COM3~COM6 : RS232 / RS422 / RS485 Connector

Connector Type: 9-pin D-Sub

Pin	RS232 Definition	RS422 / 485 Full Duplex Definition	RS485 Half Duplex Definition
1	DCD	TX-	DATA -
2	RXD	TX+	DATA +
3	TXD	RX+	
4	DTR	RX-	
5	GND		
6	DSR		
7	RTS		
8	CTS		
9	RI		



**NOTE
(NOTE)**

COM3/4/5/6 are isolated COM, each pin5 (GND) is independent.

(COM3/4/5/6 sont des COM isolés, chaque pin5 (GND) est indépendant.)

6.1.8 CFM-IGN101 Module

SW2 : IGN Module Timing Setting Switch

Set shutdown delay timer when ACC is turned off

Pin 1	Pin 2	Pin 3	Pin 4	Definition
ON (IGN Enabled) / OFF (IGN Disabled)	ON	ON	ON	0 second
	ON	ON	OFF	1 minute
	ON	OFF	ON	5 minutes
	ON	OFF	OFF	10 minutes
	OFF	ON	ON	30 minutes
	OFF	ON	OFF	1 hour
	OFF	OFF	ON	2 hours
	OFF	OFF	OFF	Reserved (0 second)

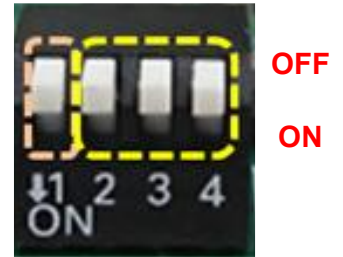

Default setting of Pin1 to Pin4 is OFF / OFF / OFF / OFF.

24V_12V_1 : IGN Module Voltage Mode Setting Switch

12V / 24V Car Battery Switch

Switch	Definition
Left	12V Car Battery Input
Right	24V Car Battery Input (Default)



6.2 Installing High Speed CMI Module

6.2.1 CMI-LAN01-R12/UB1012 Module

1. Loosen the 2 hex nuts from back side of front bezel. Remove the front bezel.

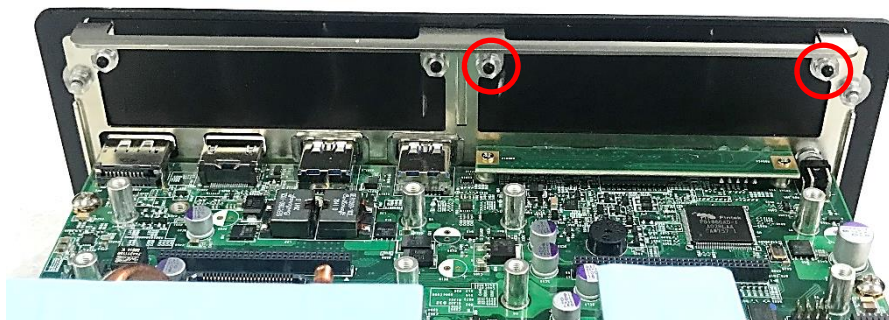

2. Attach the CMI-LAN bracket, and fasten the 2 hex nuts to fix it as indicated.



3. Locate the connector(s) of CMI-LAN module on top side of system.

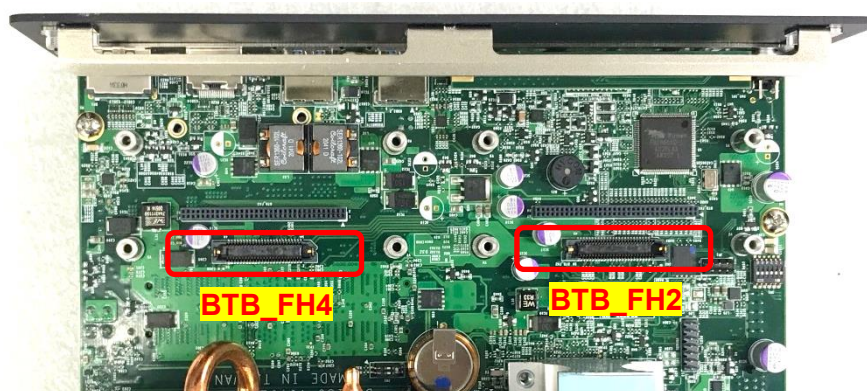

4. Insert the CMI module vertically into the female connector on system's mainboard until it's connected firmly and fasten 4 screws to fix it.

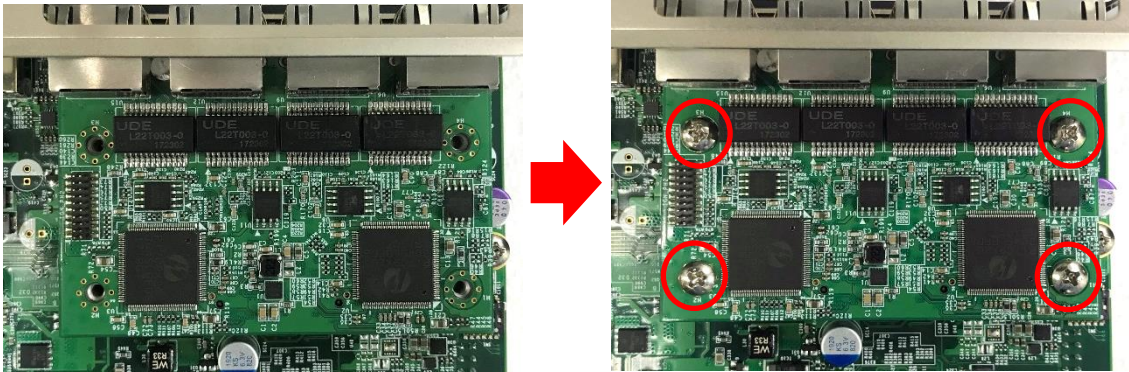

6.2.2 CMI-2P5GLAN03/UB1012 Module

Step 1. From the rear of the front panel, remove two hex nuts on the right side and remove the corresponding cover plate (see below).

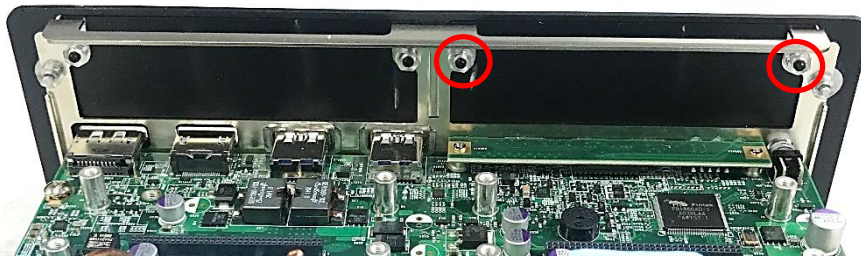

Step 2. Install the CMI-LAN bracket and fasten the two hex nuts as indicated to secure it to the system.

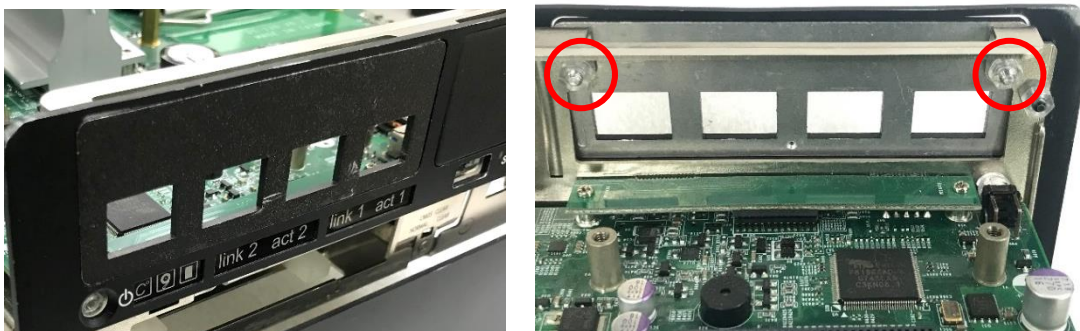

Step 3. Locate the BTB_FH1 connector on the top side of the motherboard. Only this connector supports the CMI-2P5GLAN module.

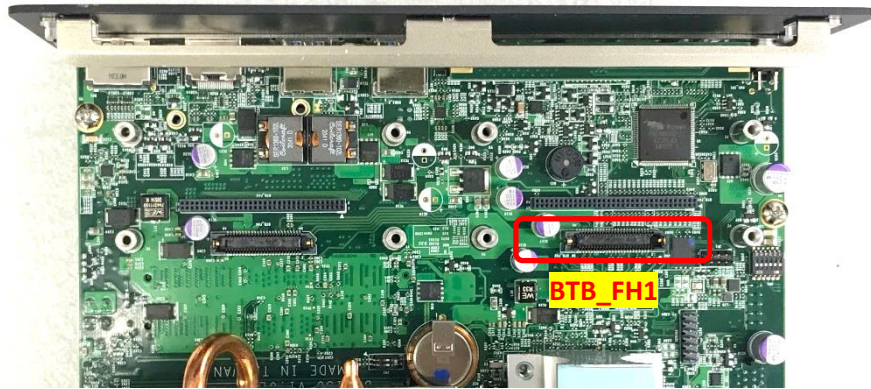

Step 4. Locate the 5 chips on the CMI-2P5GLAN module indicated by the red squares below. Carefully apply thermal pads to each chip.

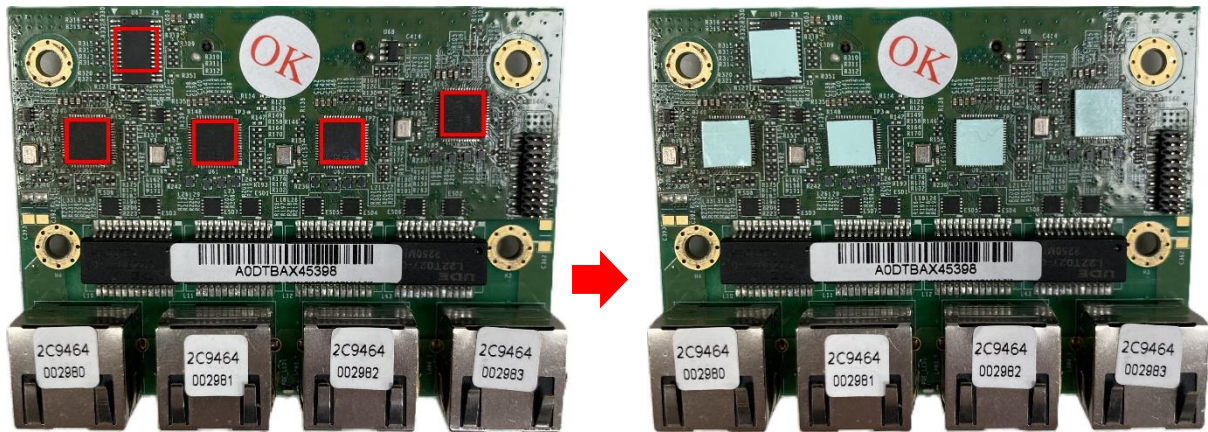

Step 5. Align the CMI module with the BTB connector and gently insert the module onto the motherboard.





CAUTION
(ATTENTION)

Before installing the heatsink (in the next step), please make sure the protective films on both sides of the thermal pad have been removed!

(Avant d'installer le dissipateur thermique (à l'étape suivante), veuillez vous assurer que les films protecteurs des deux côtés du tampon thermique ont été retirés !)

Step 6. Align the heatsink protrusions with the chip pads on the CMI module and place it onto the module.

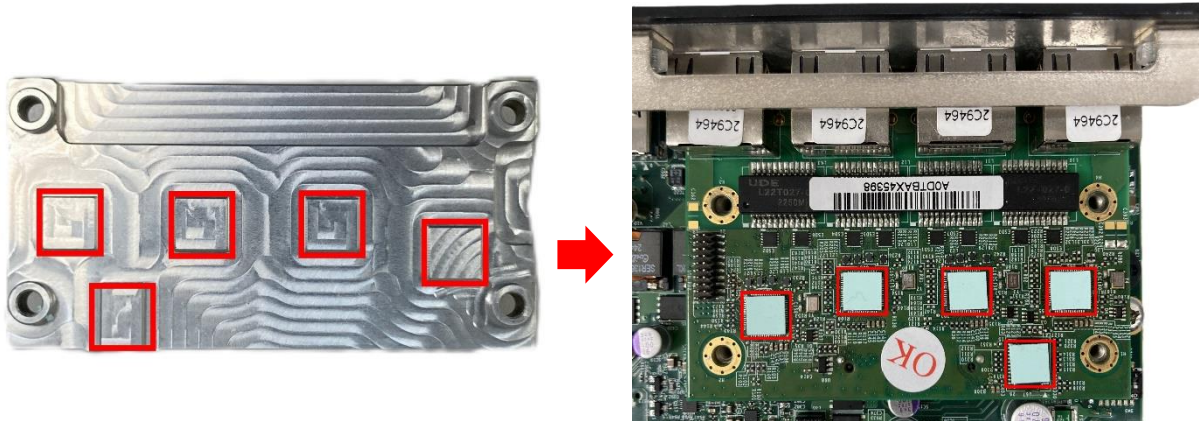

Step 7. Secure the CMI module to the motherboard using 4 screws as indicated below.

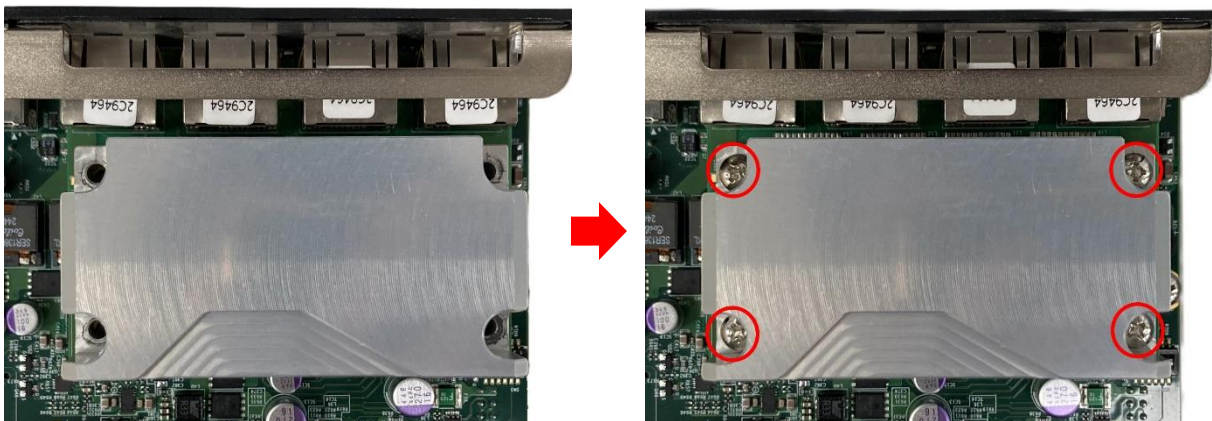

Step 8. Carefully apply a thermal pad to the heatsink.

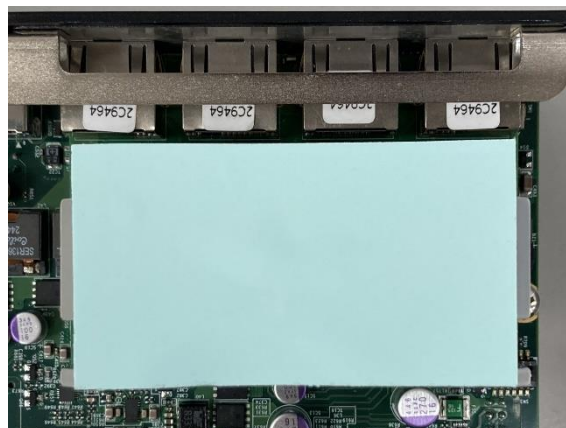



CAUTION
(ATTENTION)

Before assembling the system, please make sure the protective films on both sides of the thermal pad have been removed!
(Avant d'assembler le système, veuillez vous assurer que les films protecteurs des deux côtés du pad thermique ont été retirés !)

6.2.3 CMI-10GXM12LAN03/UB1037 Module

A BIOS setting must be configured before this module can be installed. After entering BIOS, navigate to **Chipset** > **PCH-IO**, then change the **BTB_FH2 Mode Selection** setting from **4x1** (default) to **1x4**.

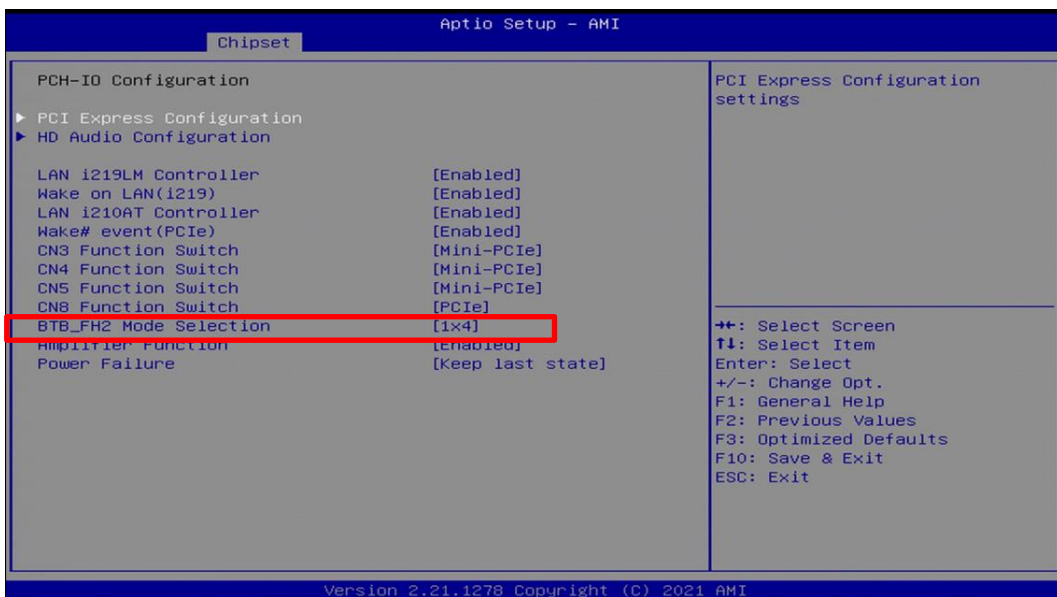

Step 1. Assemble the 10GXM12LAN bracket as indicated below: slot the hex rings through the XM12 I/O bracket and secure them from the inside with the hex nuts.

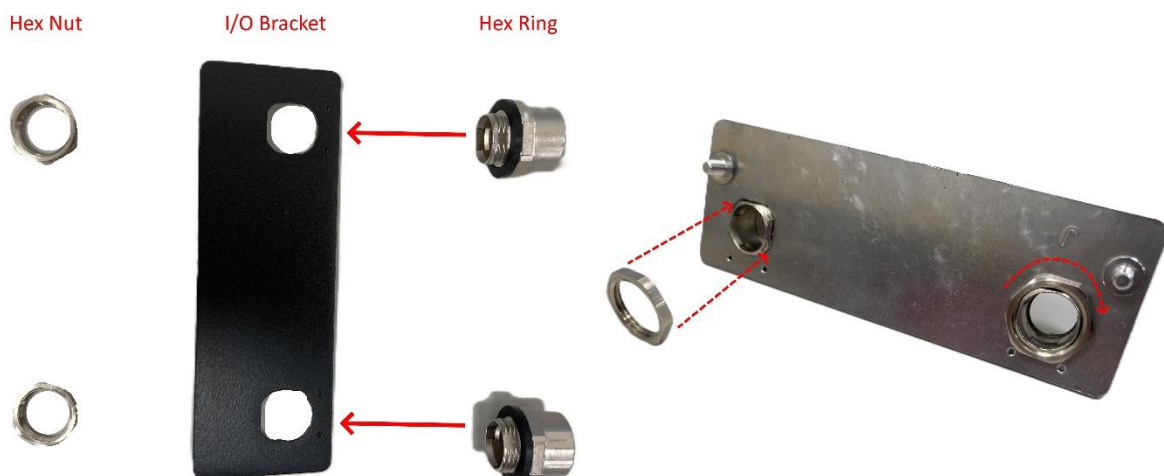

Step 2. From the rear of the front panel, remove two hex nuts on the right side and remove the corresponding cover plate (see below).

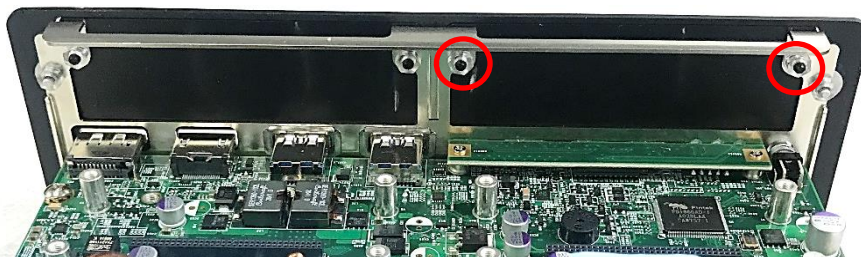

Step 3. Locate the BTB_FH2 connector on the top side of the motherboard. Only this connector supports the 10GXM12LAN module.

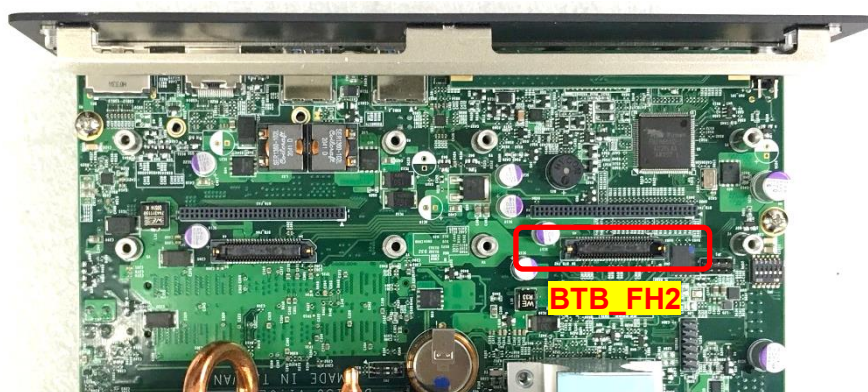

Step 4. Locate the chip on the 10GXM12LAN module indicated by the red square below. Carefully apply a thermal pad to the chip.

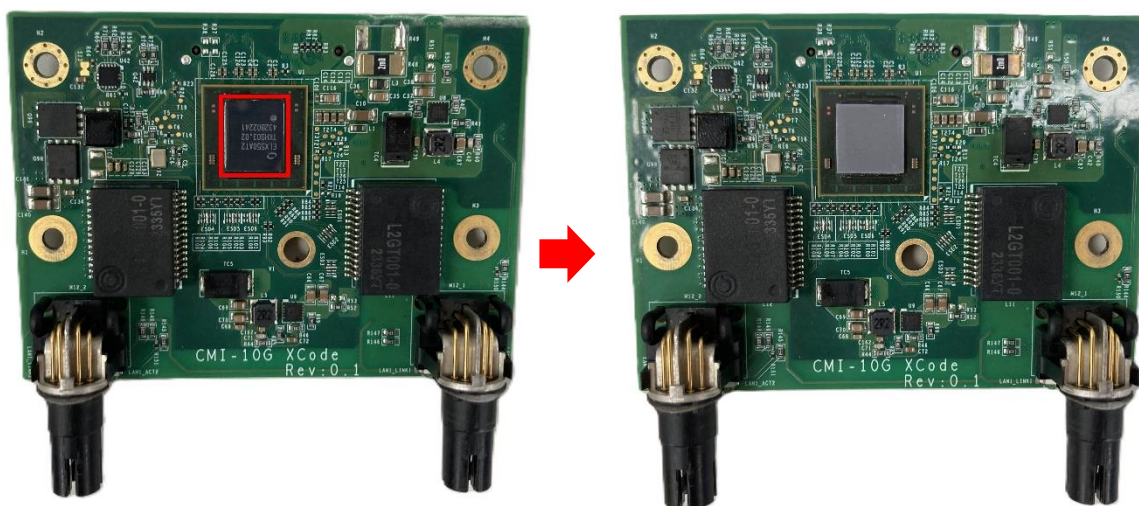

CAUTION
(ATTENTION)

Before installing the heatsink (in the next step), please make sure the protective films on both sides of the thermal pad have been removed!

(Avant d'installer le dissipateur thermique (à l'étape suivante), veuillez vous assurer que les films protecteurs des deux côtés du tampon thermique ont été retirés !)

Step 5. Install the heatsink and flip the module over. Secure the heatsink with a screw as indicated.

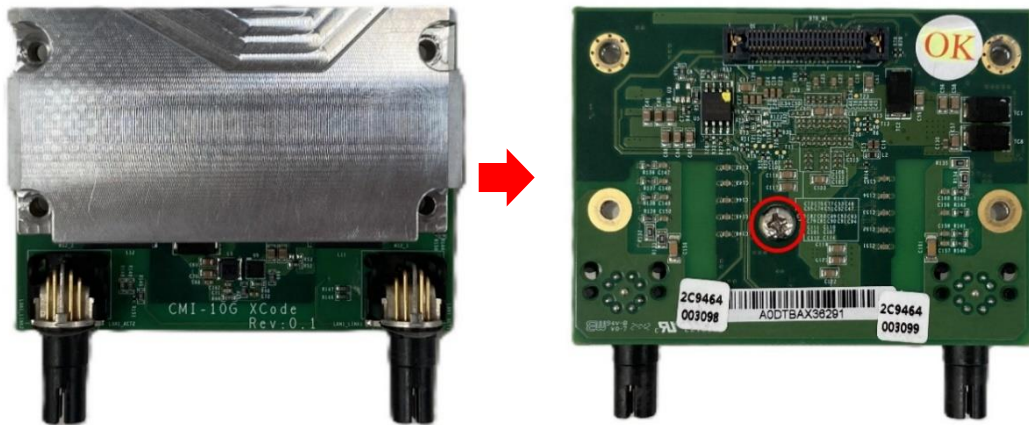

Step 6. Align the CMI module with the BTB connector and gently insert the module onto the motherboard. Secure the module to the motherboard using 4 screws as indicated below.

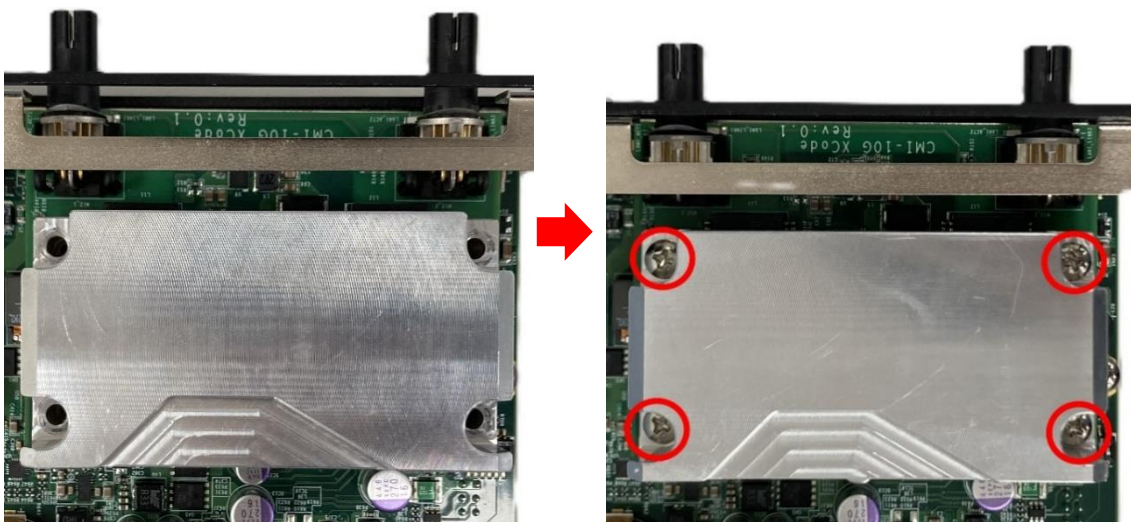

Step 7. Install the 10GXM12LAN bracket and fasten the two hex nuts as indicated to secure it to the system.

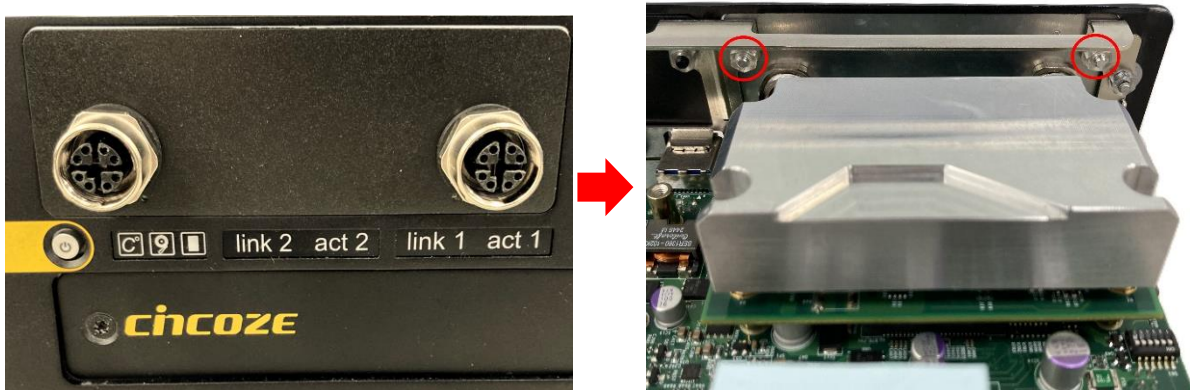

Step 8. Carefully apply a thermal pad to the heatsink.

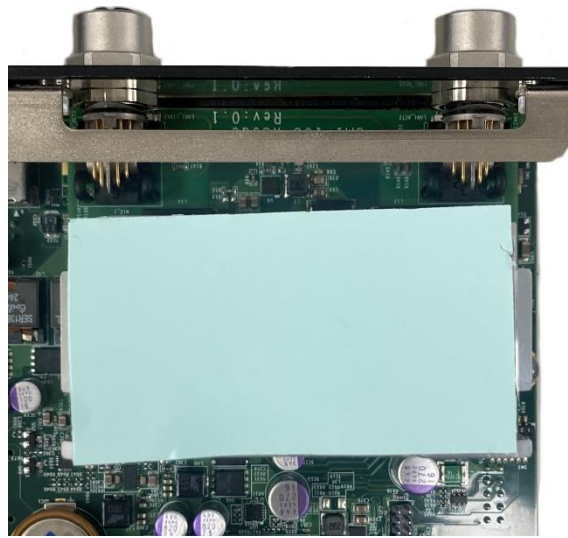

**CAUTION
(ATTENTION)**

Before assembling the system, please make sure the protective films on both sides of the thermal pad have been removed!
(Avant d'assembler le système, veuillez vous assurer que les films protecteurs des deux côtés du pad thermique ont été retirés !)

Step 9. Insert the rubber rings into the XM12LAN ports. Tweezers are recommended.



6.2.4 CMI-M12LAN01-R12/UB1010 Module

1. Loosen the 2 hex nuts from back side of front bezel. Remove the front bezel.

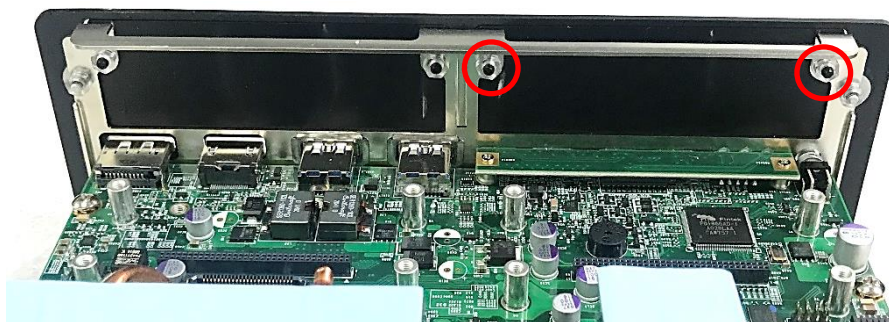

2. Attach the CMI-M12LAN bracket, and fasten the 2 hex nuts to fix it as indicated.



3. Locate the connector(s) of CMI-M12LAN module on top side of system.

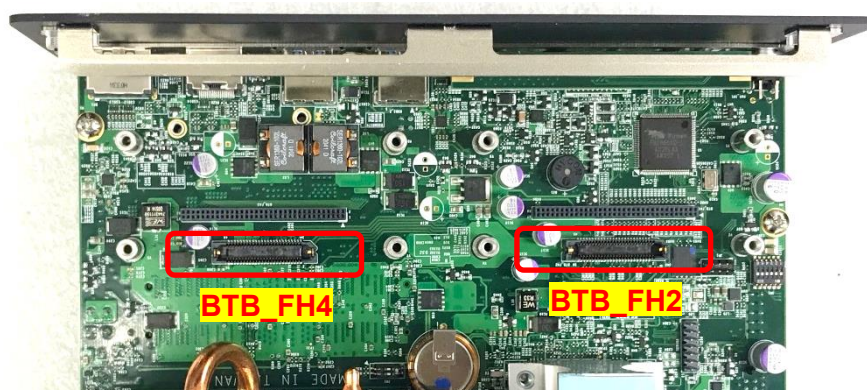

- Remove the four hex rings from the CMI-M12LAN module.

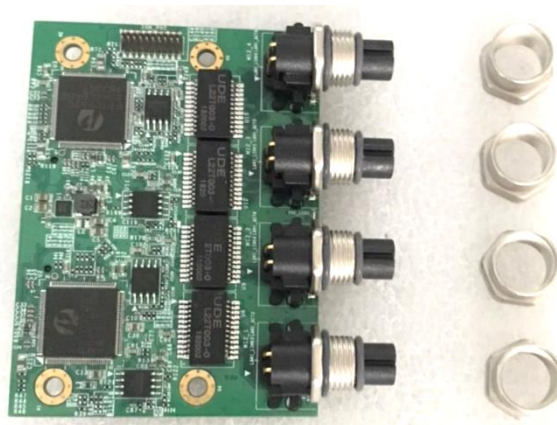

- Penetrate the CMI-M12LAN ports through the holes on the bracket. Insert the CMI module vertically into the female connector on system's mainboard until it's connected firmly and fasten 4 screws to fix it.

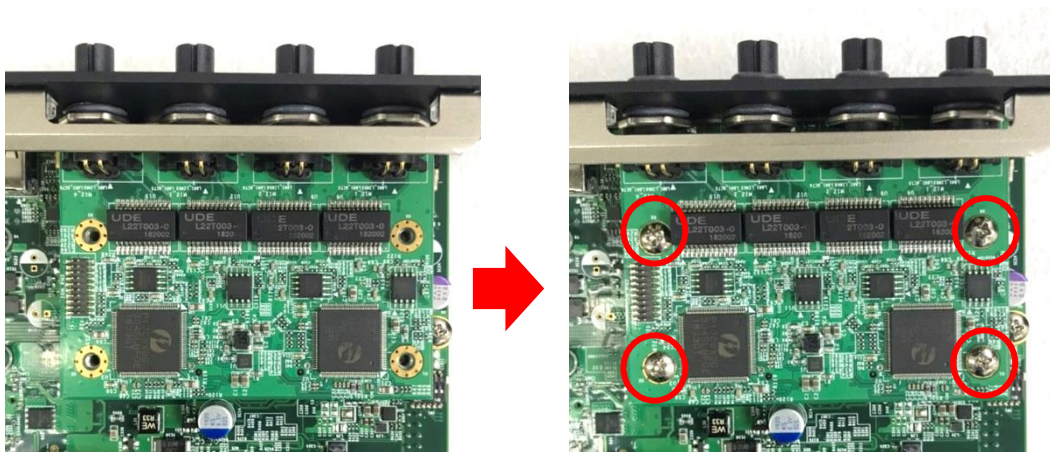

- Fasten the four hex rings to fix the cover plate.



6.2.5 CMI-XM12LAN01-R10/UB1030 Module

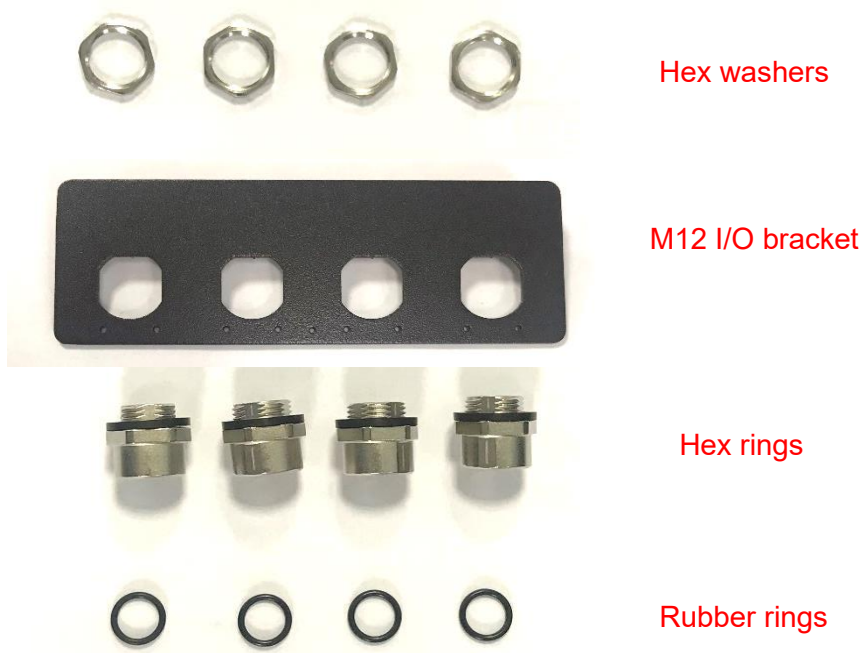

1. Assemble the hex rings, M12 I/O bracket and hex washers together as indicated below: Penetrate hex rings through the M12 I/O bracket holes, and fix them with hex washers.



- Loosen the 2 hex nuts from back side of front bezel. Remove the front bezel.

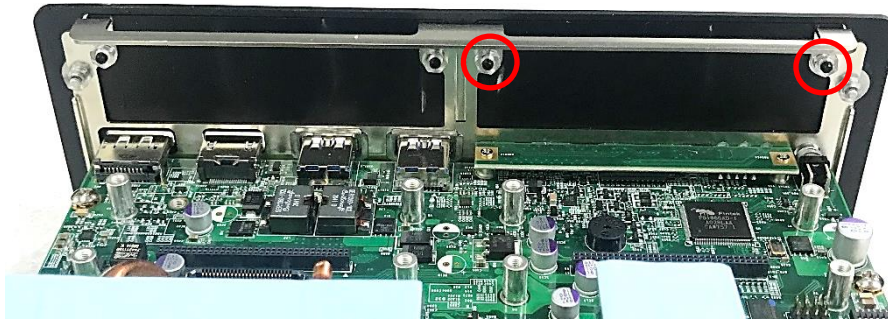

- Locate the connector(s) of CMI-M12LAN module on top side of system.

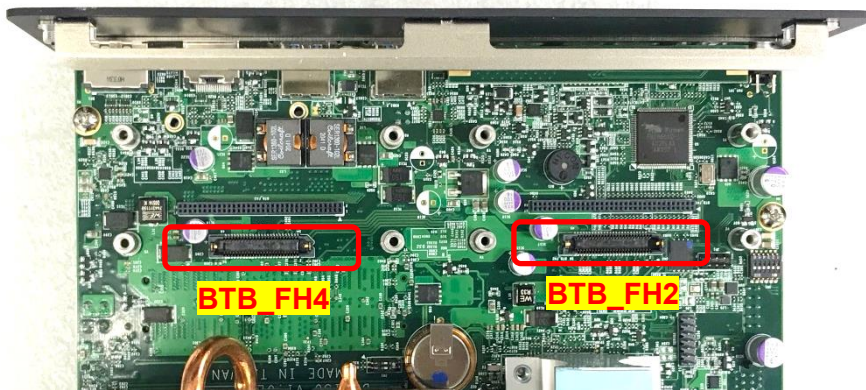

- Insert the CMI module vertically into the female connector on system's mainboard until it's connected firmly and fasten 4 screws to fix it.

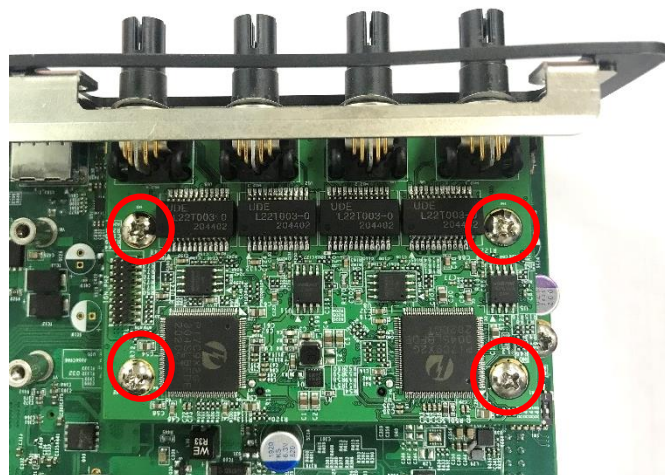

5. Attach the assembled M12 I/O bracket on to the system, and fasten the hex nuts to fix it.

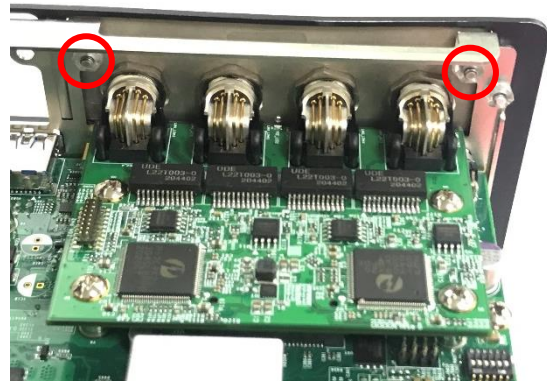

6. Put on the rubber rings to the four M12 LAN ports.

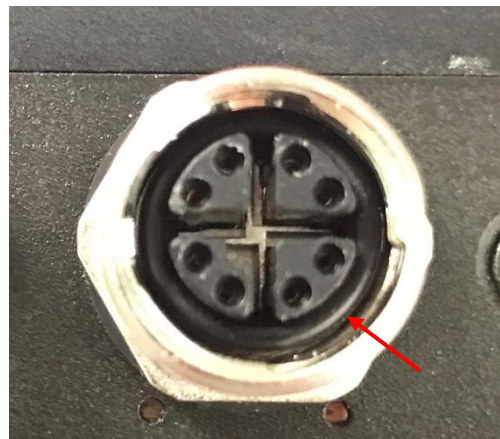

6.2.6 CMI-10GLAN03-R10/UB1028 Module

Before installing CMI-10GLAN03-R10/UB1028 module, users need to enter BIOS to complete the following setting first. When entering BIOS, get to Chipset > PCH-IO Configuration page, and change the [BTB_FH2 Mode Selection] setting from default mode [4x1] to mode [1x4].

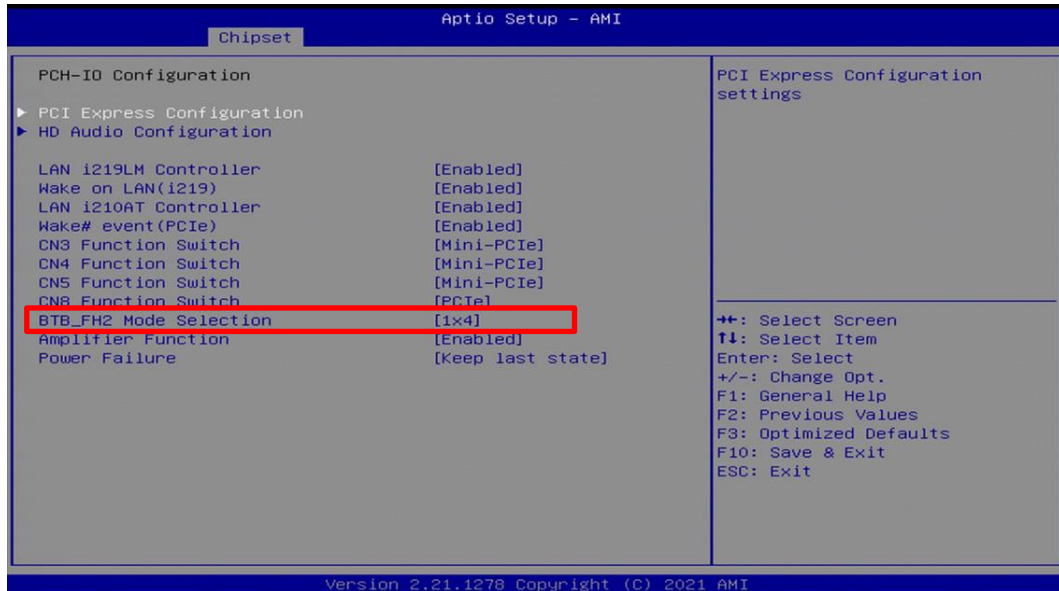

1. Loosen the 2 hex nuts from back side of front bezel. Remove the front bezel.

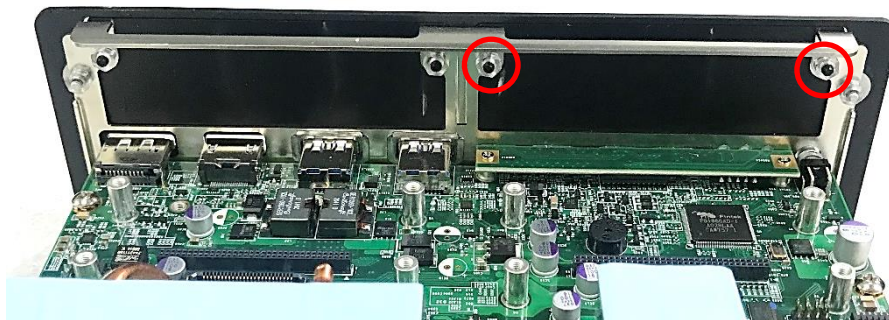

2. Attach the CMI-10GLAN bracket, and fasten the 2 hex nuts to fix it as indicated.



3. Locate the BTB_FH2 connector on top side of system. Only this connector supports the CMI-10GLAN module.

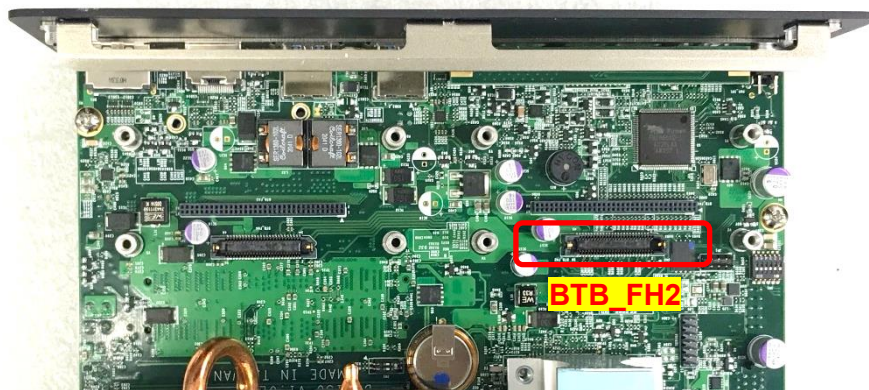

4. Locate the chip place on the CMI-10GLAN module marked by red square. Paste the thermal pad on it carefully.

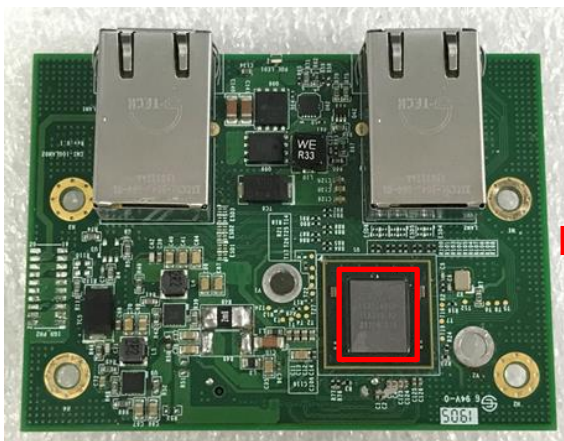

CAUTION
(ATTENTION)

Before installing the heatsink (in the next step), please make sure the protective films on both sides of the thermal pad have been removed!

(Avant d'installer le dissipateur thermique (à l'étape suivante), veuillez vous assurer que les films protecteurs des deux côtés du tampon thermique ont été retirés !)

5. Put on the heatsink and turn over the module. Fasten the screw to fix the heatsink.

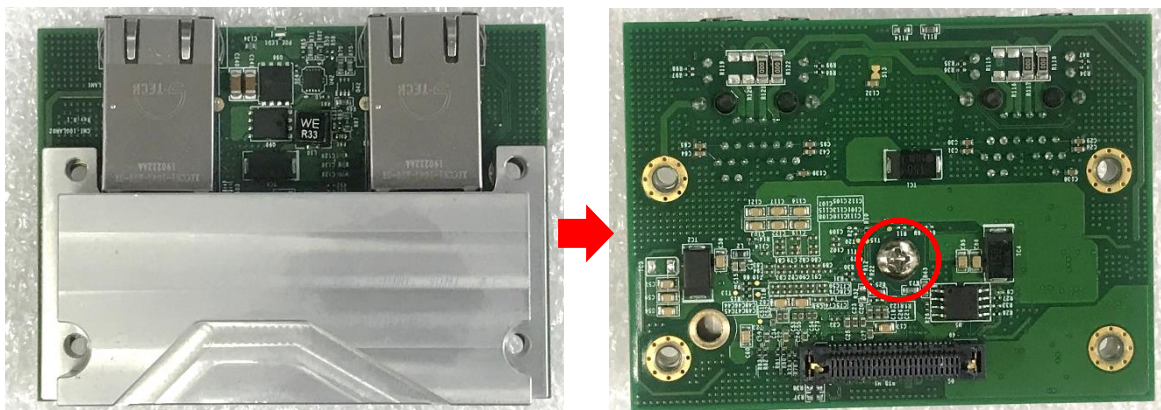

6. Insert the CMI module vertically into the female connector on system's mainboard until it's connected firmly and fasten 4 screws to fix it.

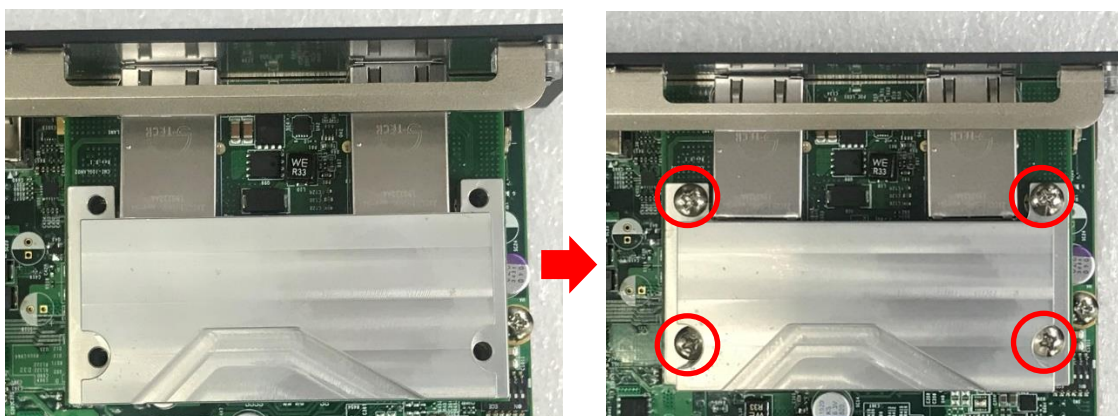

7. Paste the thermal pad onto the heatsink carefully.



CAUTION
(ATTENTION)

Before assembling the system, please make sure the protective films on both sides of the thermal pad have been removed!

(Avant d'assembler le système, veuillez vous assurer que les films protecteurs des deux côtés du pad thermique ont été retirés !)

6.2.7 CMI-CAN01-R10/UB1038 Module

1. Loosen the 2 hex nuts from back side of front bezel. Remove the front bezel.

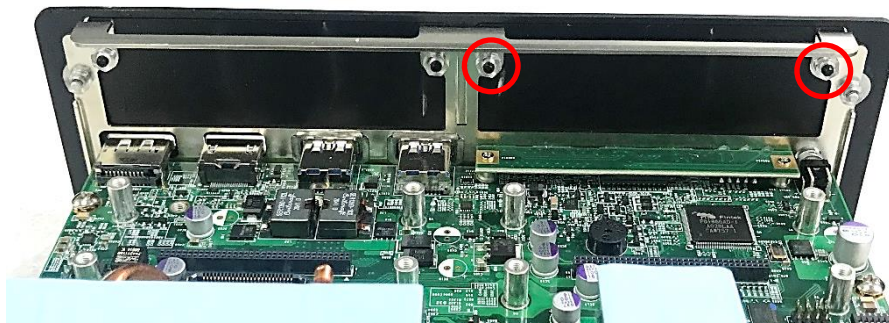

2. Locate the connector(s) of the CMI-CAN module on the top side of the system. Choose one connector to install the module.

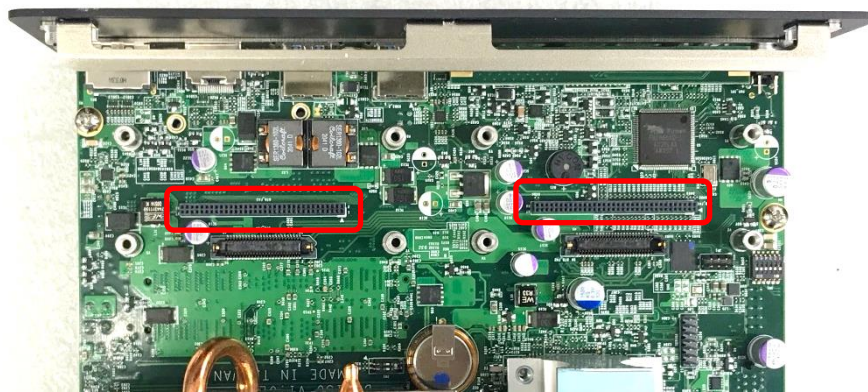

3. Insert the CMI module vertically into the female connector on system's mainboard until it's connected firmly and fasten 4 screws to fix it.



4. Fasten the 2 hex nuts from the back side of front bezel.

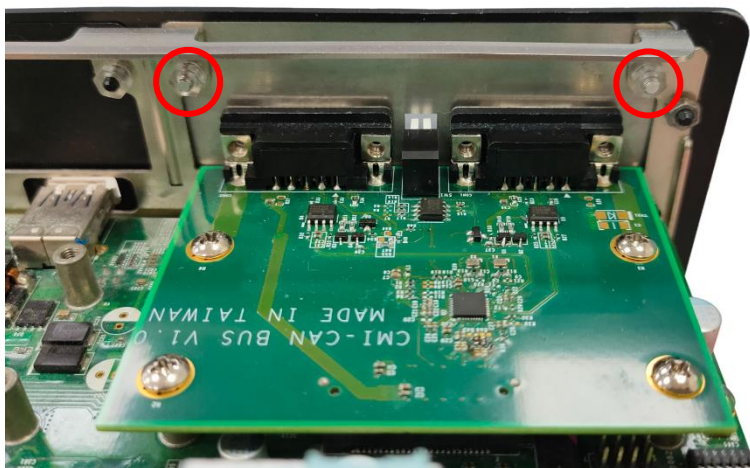

5. Fasten 4 D-Sub jack screws to secure it.



6.3 Installing Low Speed CMI Module

6.3.1 CMI-DIO02/UB1018 Module

1. Loosen the 2 hex nuts from back side of front bezel. Remove the front bezel.

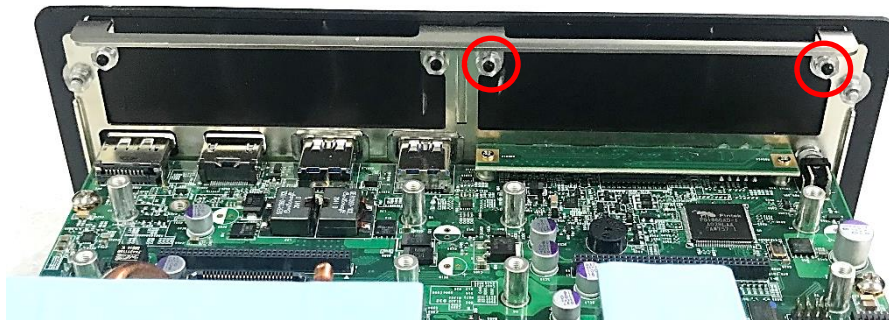

2. Attach the CMI-DIO bracket, and fasten the 2 hex nuts to fix it as indicated.



3. Locate the connector(s) of CMI-DIO module on top side of system.

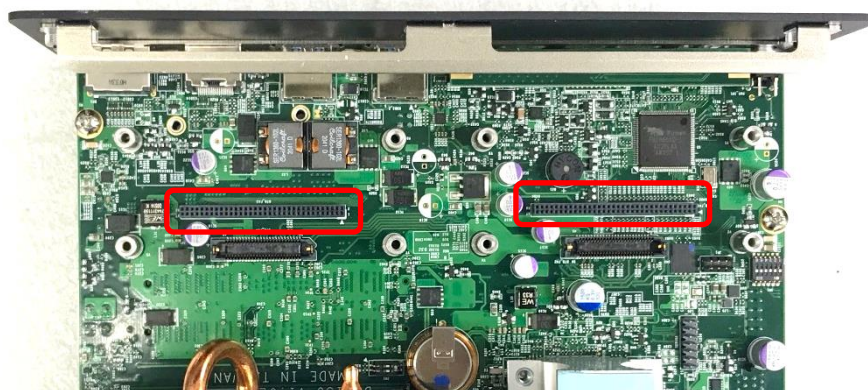

4. Insert the CMI module vertically into the female connector on system's mainboard until it's connected firmly and fasten the 2 screws to fix it.

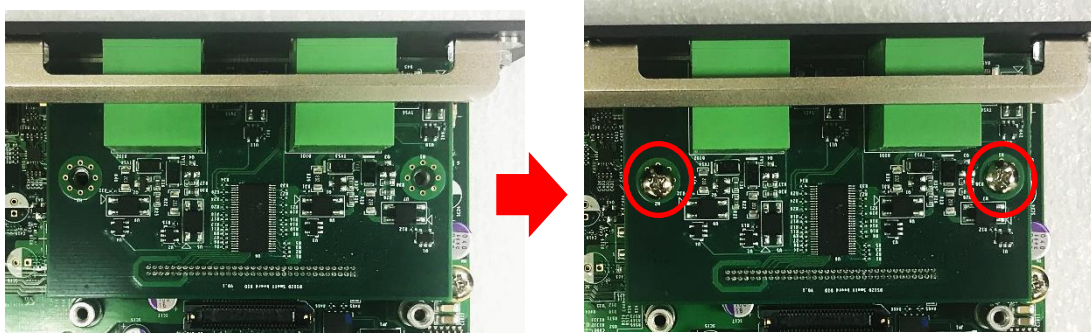

6.3.2 CMI-COM02/UB1004 Module

6. Loosen the 2 hex nuts from back side of front bezel. Remove the front bezel.

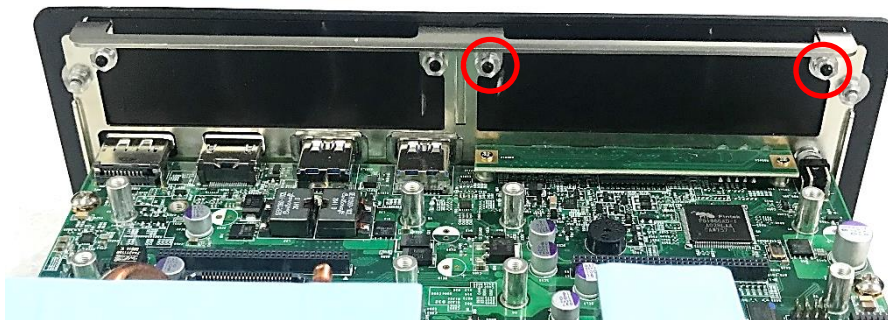

7. Locate the connector(s) of the CMI-COM module on the top side of the system. Choose one connector to install the module.

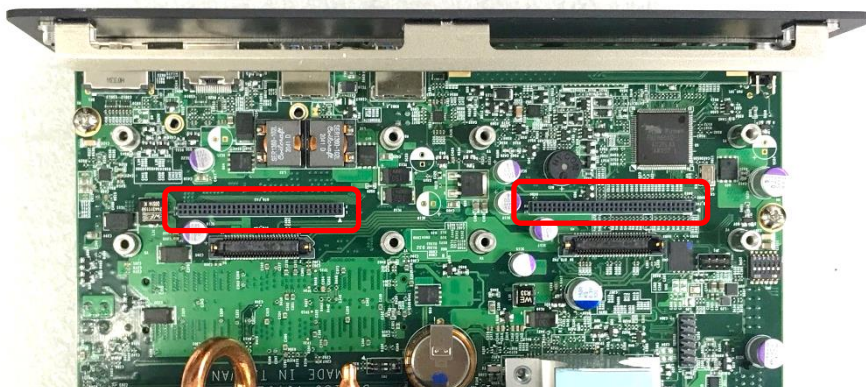

NOTE
(NOTE)

The DS-1300 series supports up to one CMI-COM module at a time.

(La série DS-1300 prend en charge un seul module CMI-COM à la fois.)

- Penetrate the COM ports of the CMI-COM module through the holes on the bracket. Insert the CMI module vertically into the female connector on system's mainboard until it's connected firmly and fasten 2 screws to fix it.

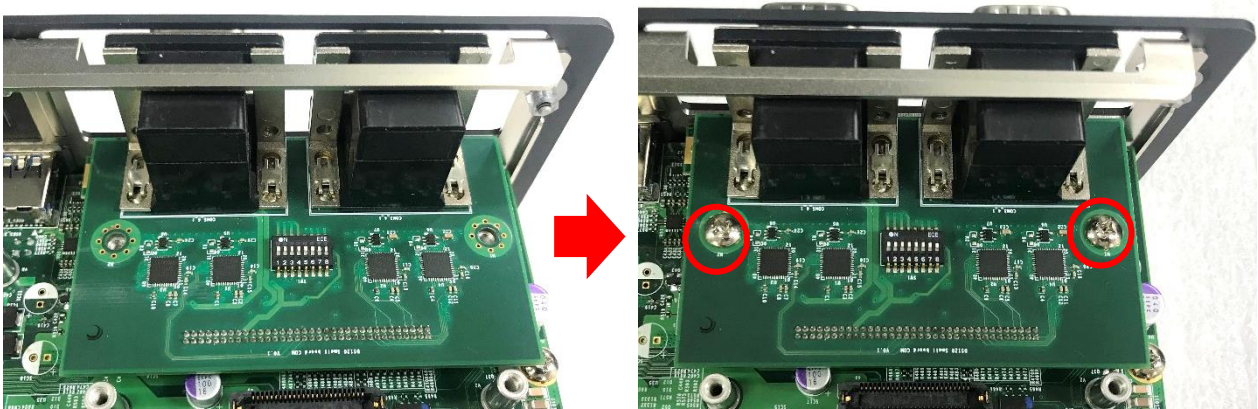

- Attach the CMI-COM bracket, and fasten the 2 hex nuts to fix it as indicated.

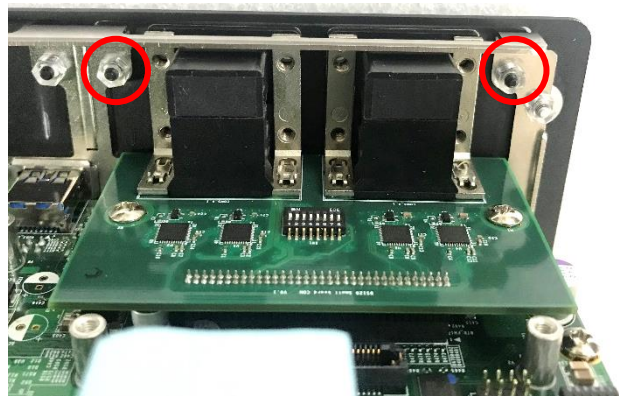

- Fasten the 8 D-Sub jack screws to fix the module.



6.3.3 CMI-ICOM01/UB1004 Module

1. Loosen the 2 hex nuts from back side of front bezel. Remove the front bezel.

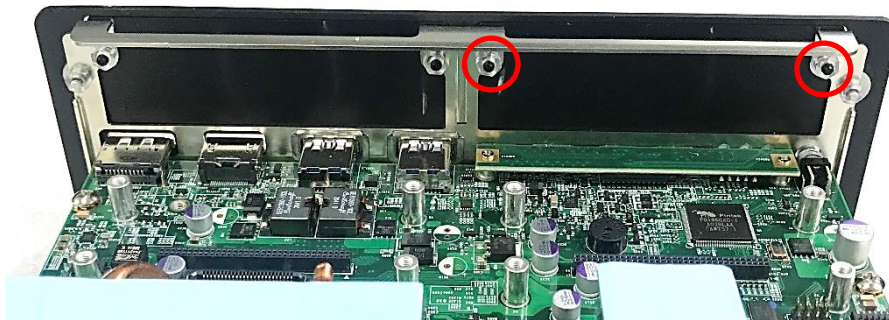

2. Locate the connector(s) of the CMI-ICOM module on the top side of the system. Choose one connector to install the module.

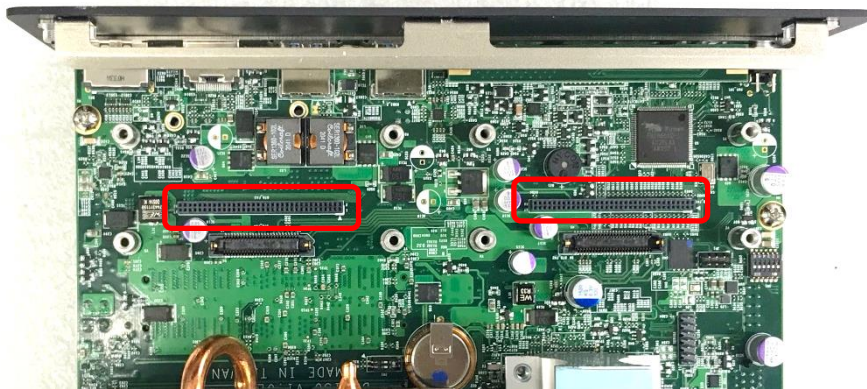

NOTE
(NOTE)

The DS-1300 series supports up to one CMI-ICOM module at a time.

(La série DS-1300 prend en charge un seul module CMI-ICOM à la fois.)

3. Penetrate the COM ports of the CMI-ICOM module through the holes on the bracket. Insert the CMI module vertically into the female connector on system's mainboard until it's connected firmly and fasten 2 screws to fix it.

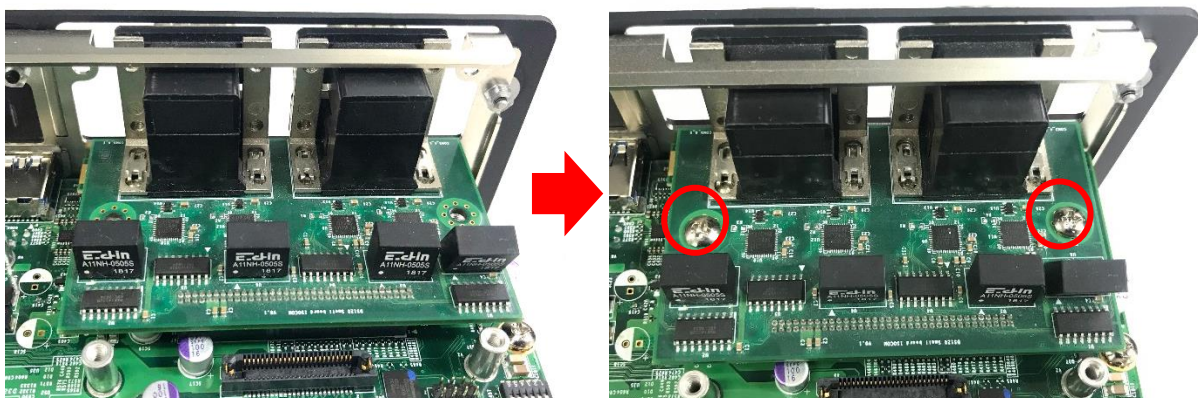

4. Attach the CMI-ICOM bracket, and fasten the 2 hex nuts to fix it as indicated.

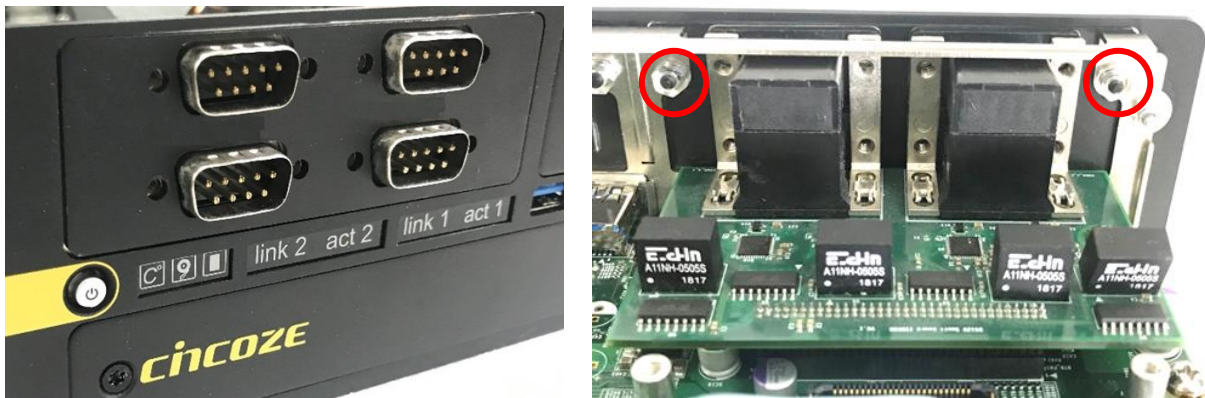

5. Fasten the 8 D-Sub jack screws to fix the module.



6.4 Installing CFM Module

6.4.1 CFM-PoE03 Module

CFM-PoE03 module can be installed on CMI-LAN or CMI-M12LAN module. When using CMI-LAN01-R12 Module, please paste the shading tape to the place which was marked by red frame. (Watch out not to block the LED.) If you use CMI-M12LAN01-R12 Module, please skip this step.

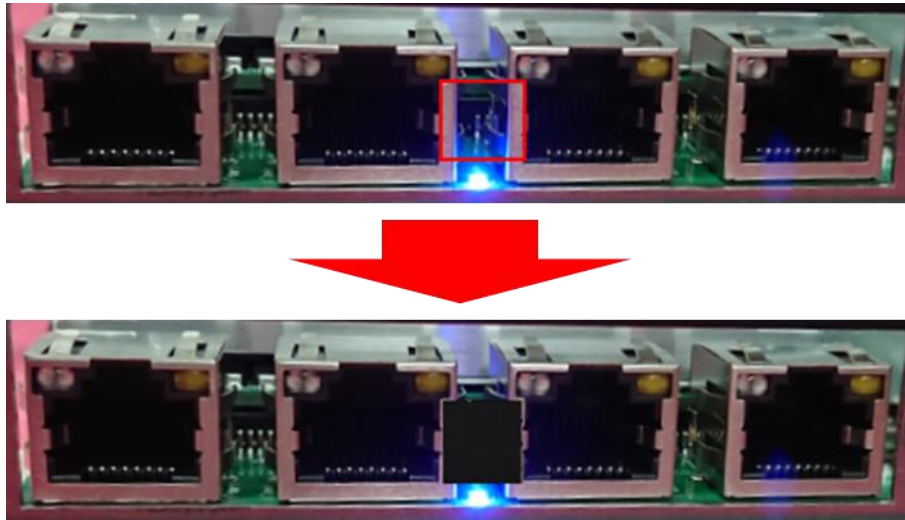

In this chapter, CMI-M12LAN module is taken as an example to demonstrate how to install CFM-PoE03 on it. Before this chapter gets started, please execute the installation step 1 to step 4 in chapter 6.2.2 in advance.

1. Penetrate the CMI-M12LAN ports through the holes on the bracket. Insert the CMI module vertically into the female connector on system's mainboard until it's connected firmly and fasten 4 copper pillars to fix CMI-M12LAN module.

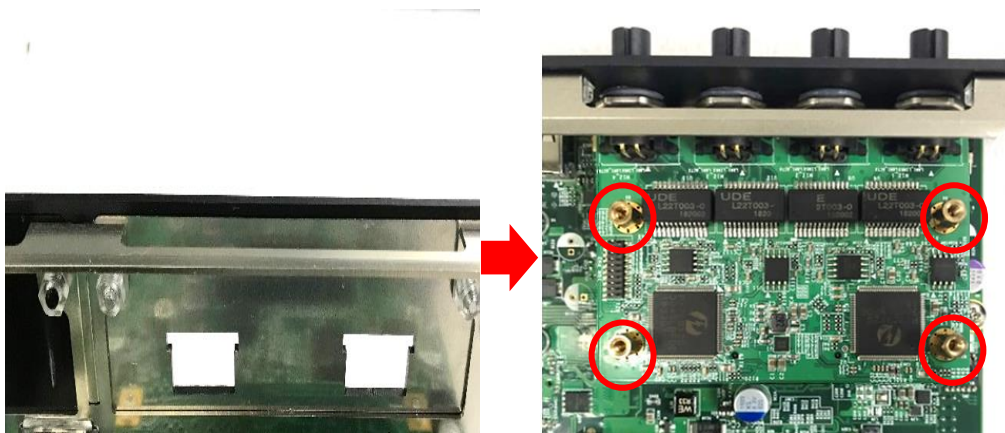

2. Insert the CFM-PoE03 module vertically into the female connector on CMI module until it's connected firmly.



3. Please paste the 1 thermal pad onto the coil of the CFM-PoE03 module carefully, and then remove the protective film on it.



4. Turn over the heatsink and locate the two places which were marked by red circles, and then paste the 2 thermal pads onto the heatsink carefully.

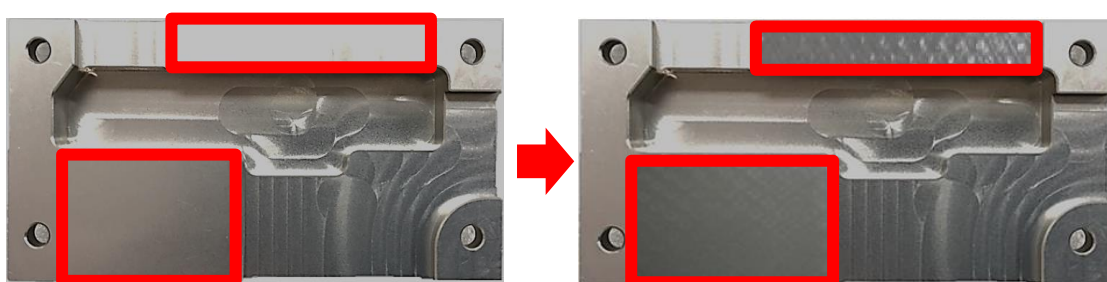

CAUTION
(ATTENTION)

Before installing the heatsink (in the next step), please make sure the protective film on the thermal pads have been removed!

(Avant d'installer le dissipateur thermique (à l'étape suivante), veuillez vous assurer que le film protecteur sur les tampons thermiques a été retiré !)

5. Please paste the heatsink onto the CFM-PoE03 module carefully, and fasten 4 screws to fix it.

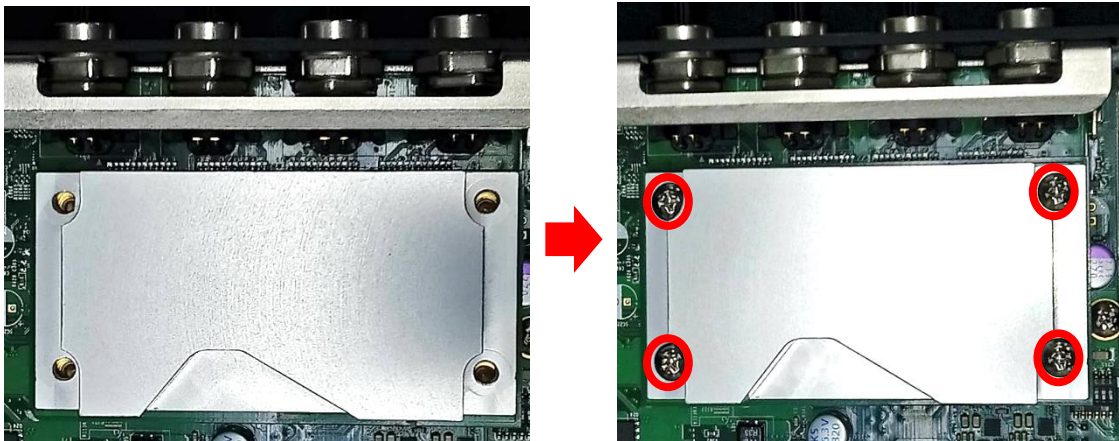

6. Paste the thermal pad onto the heatsink carefully, and execute the step 6 in Chapter 6.2.2.

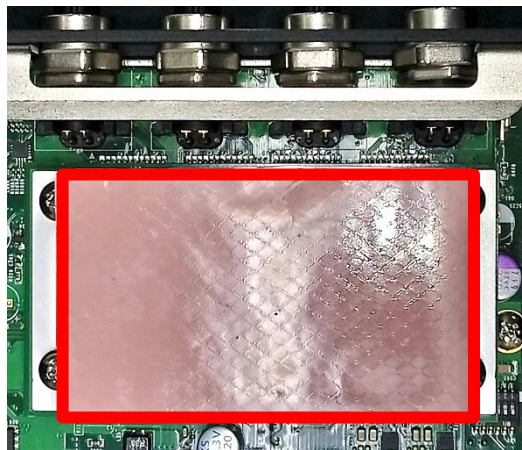

CAUTION
(ATTENTION)

Before assembling the system, please make sure the protective films on both sides of the thermal pad have been removed!

(Avant d'assembler le système, veuillez vous assurer que les films protecteurs des deux côtés du tampon thermique ont été retirés !)

Once the steps are finished, after system power on, PoE LED (on CMI-LAN or CMI-M12 LAN module) will light blue as shown below.



6.4.2 CFM-IGN101 Module

1. Locate the power Ignition connector on the bottom side of the system.

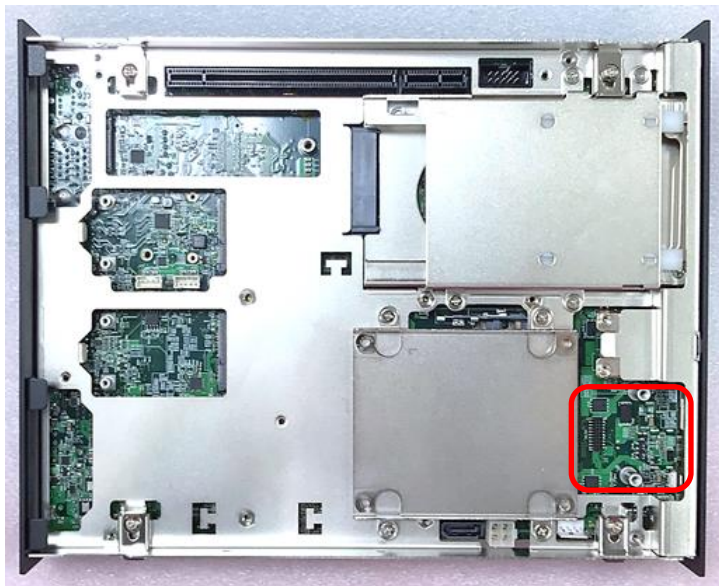

2. Insert the connector of IGN module to the female connector on system motherboard. (Make sure all the pins of IGN module's connector are firmly connected.)



3. Fasten the two screws to secure the power ignition board.



6.5 Installing MEC Module

This chapter takes DS-1302 as an example to demonstrate the installation of MEC modules.

6.5.1 MEC-COM-M212-DB9/UB0303 Module

1. Loosen 4 screws on the two cover plates of number 3/4/5 and then remove it. In the following steps, we use cover plate 4 and 5 for example. (To perform this step, users must remove both cover plates located on the rear side of the DS-1300 or DS-1301 system. For more detailed information, please refer to the Ordering Information section of the DS-1300 or DS-1301 datasheet.)

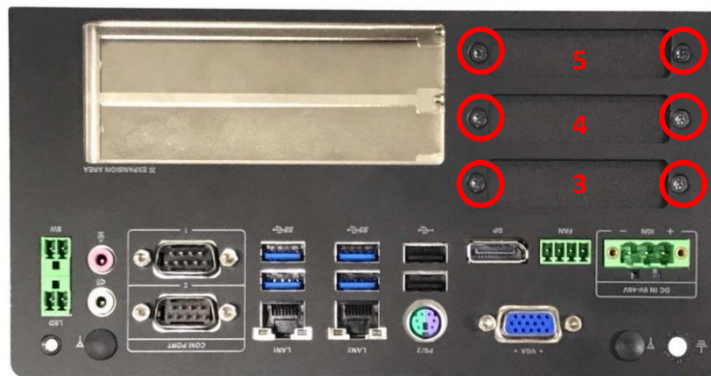

2. Attach the MEC-COM brackets, and fasten the 4 screws to fix it as indicated.

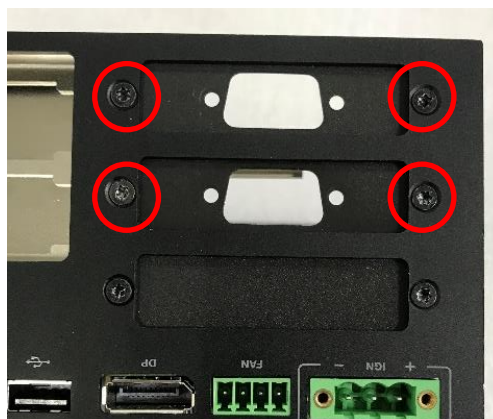

3. Locate one of the Mini PCIe sockets on the bottom side of the system. In this chapter, we use CN4 for example.

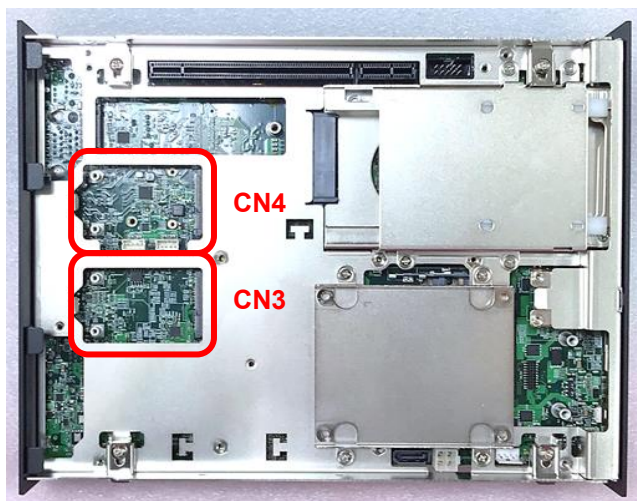

4. Tilt the Mini PCIe card at a 45-degree angle and insert it to the socket until the golden finger connector of the card seated firmly.



5. Press the card down and secure it with 2 screws.

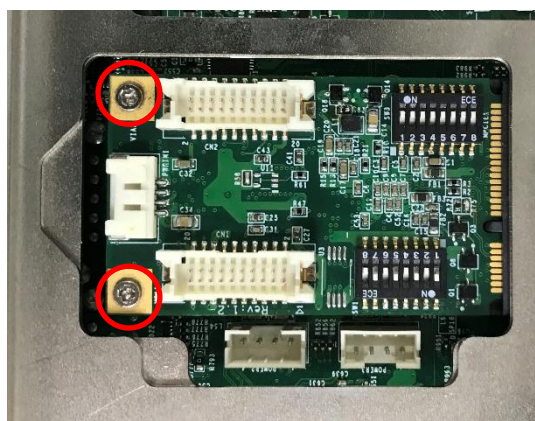

6. Remove the 4 D-Sub jack screws from the COM ports.

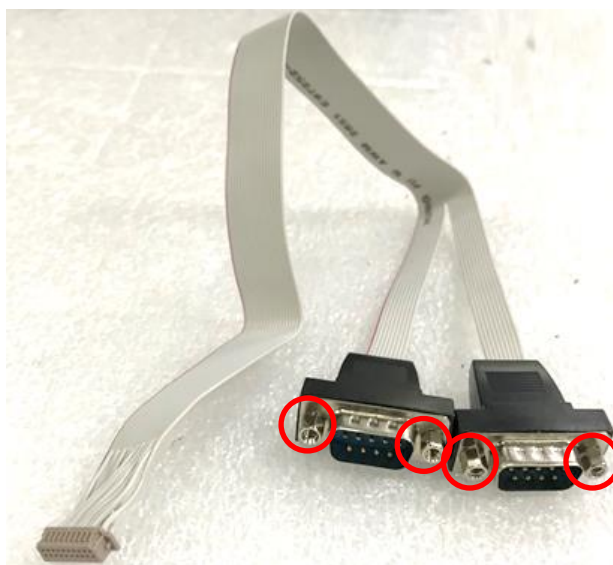

7. Connect the other end of the wire to the Mini PCIe card as indicated.

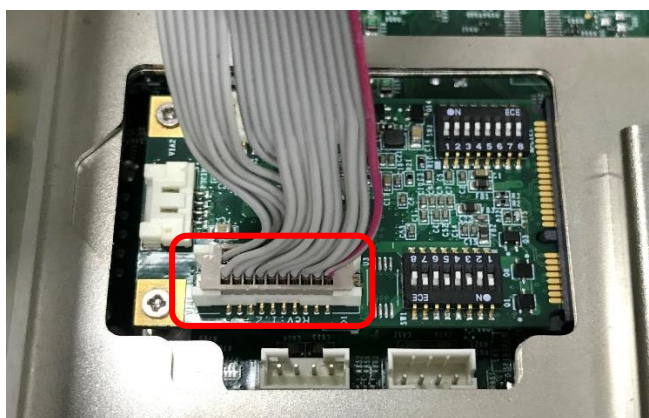

8. Attach the COM ports onto the back side of the cover plates, and then fasten the 4 D-Sub jack screws to secure the COM ports.

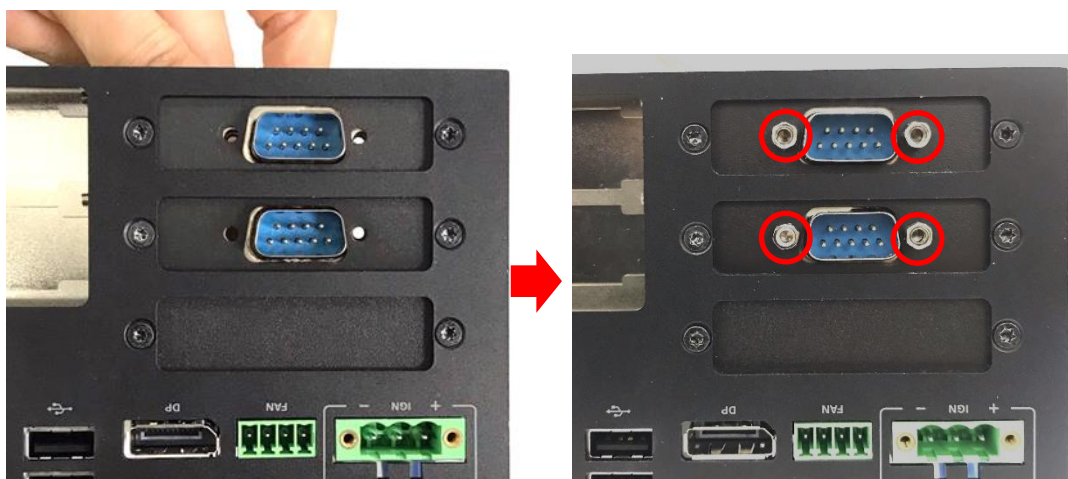

6.5.2 MEC-USB-M102-30/UB0314 Module

1. Loosen 2 screws on the cover plate of number 3/4/5 and then remove it. In the following steps, we use cover plate 5 for example.

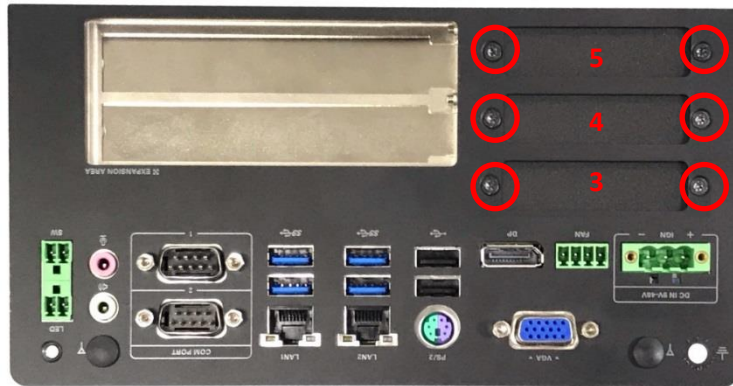

2. Attach the MEC-USB bracket, and fasten the 2 screws to fix it as indicated.

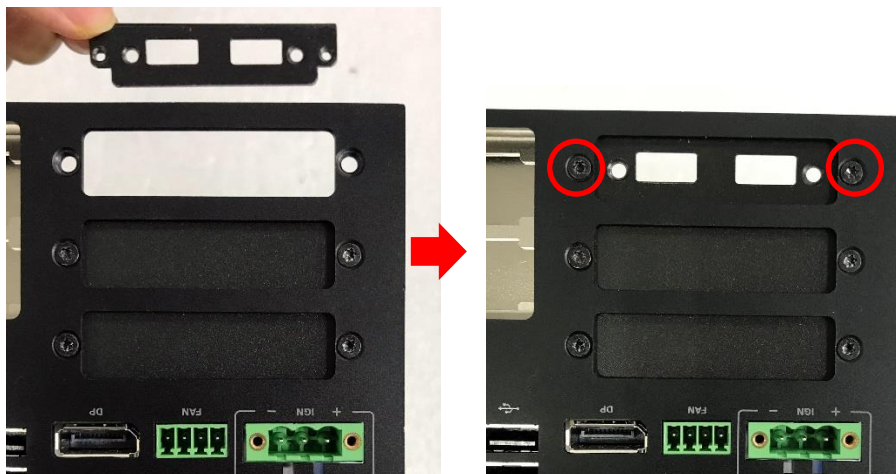

3. Locate one of the Mini PCIe sockets on the bottom side of the system. In this chapter, we use CN4 for example.

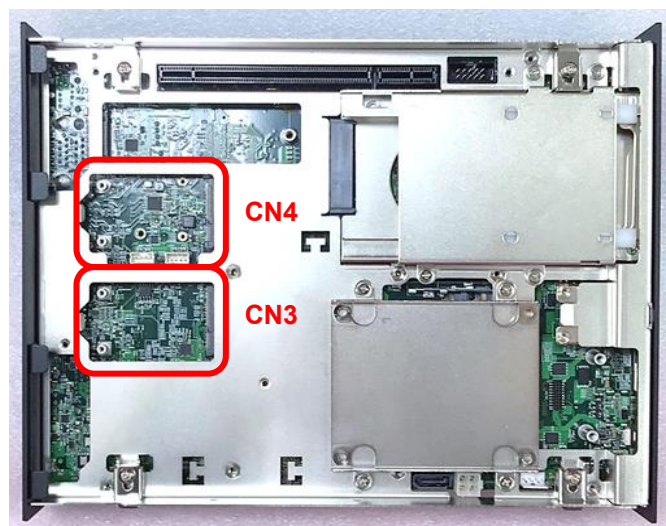

4. Tilt the Mini PCIe card at a 45-degree angle and insert it to the socket until the golden finger connector of the card seated firmly.



5. Press the card down and secure it with 2 screws.

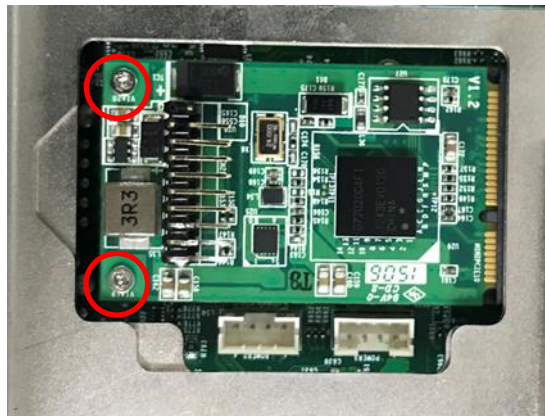

6. Connect the attached wire to the USB board.



7. Connect the other end of the wire to the Mini PCIe card as indicated.

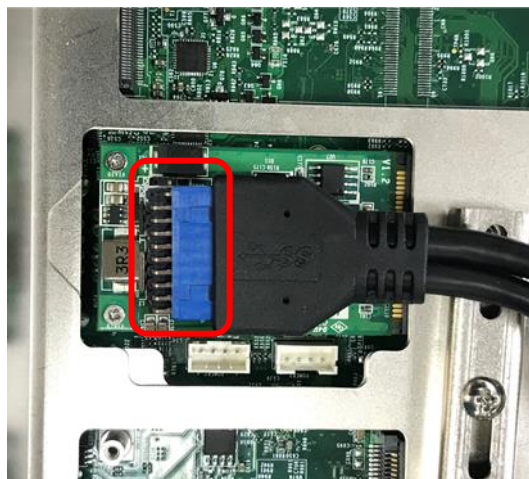

8. Attach the USB board onto the back side of the cover plate, and then fasten the two screws to secure the module.

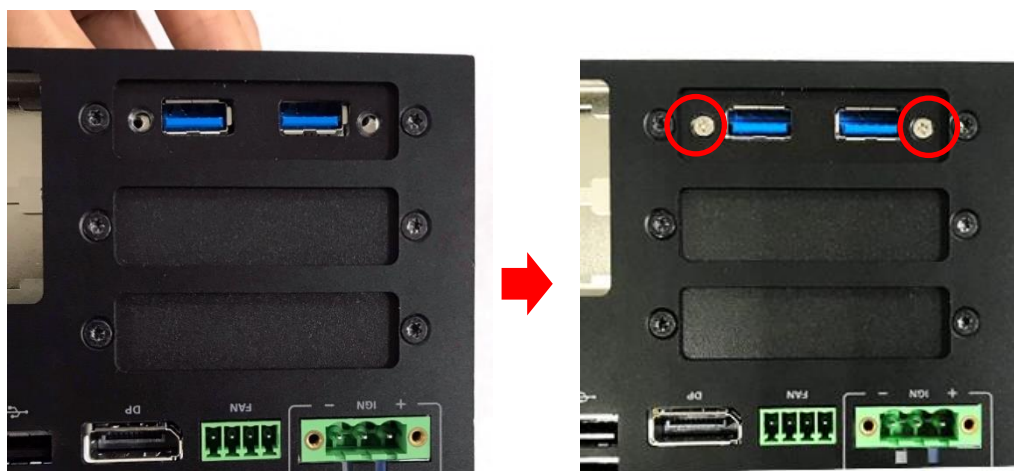

6.5.3 MEC-LAN-M102-30/UB0311 Module

1. Loosen 2 screws on the cover plate of number 3/4/5 and then remove it. In the following steps, we use cover plate 5 for example.

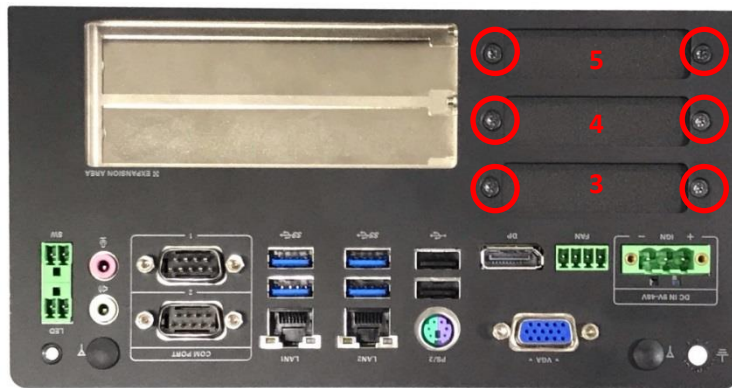

2. Attach the MEC-LAN bracket, and fasten the 2 screws to fix it as indicated.

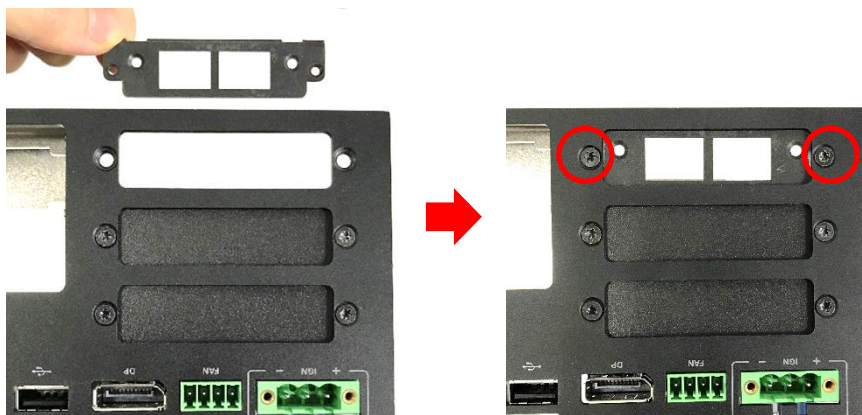

3. Locate one of the Mini PCIe sockets on the bottom side of the system. In this chapter, we use CN4 for example.

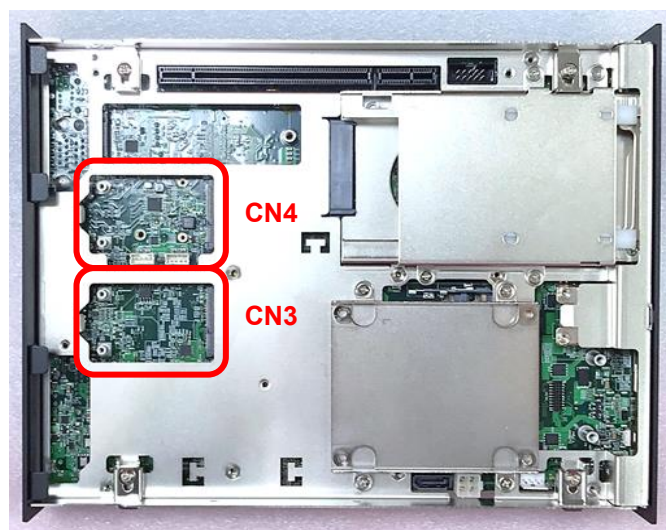

4. Tilt the Mini PCIe card at a 45-degree angle and insert it to the socket until the golden finger connector of the card seated firmly.



5. Press the card down and secure it with 2 screws.

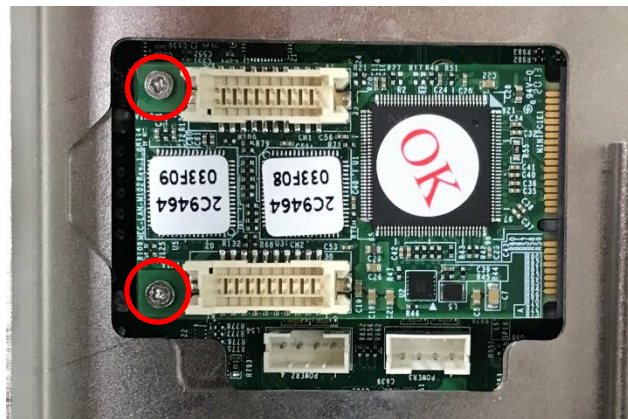

6. Connect the attached wires to the LAN board.



7. Connect the wires to the Mini PCIe card as indicated.



8. Attach the LAN board onto the back side of the cover plate, and then fasten the two screws to secure the module.

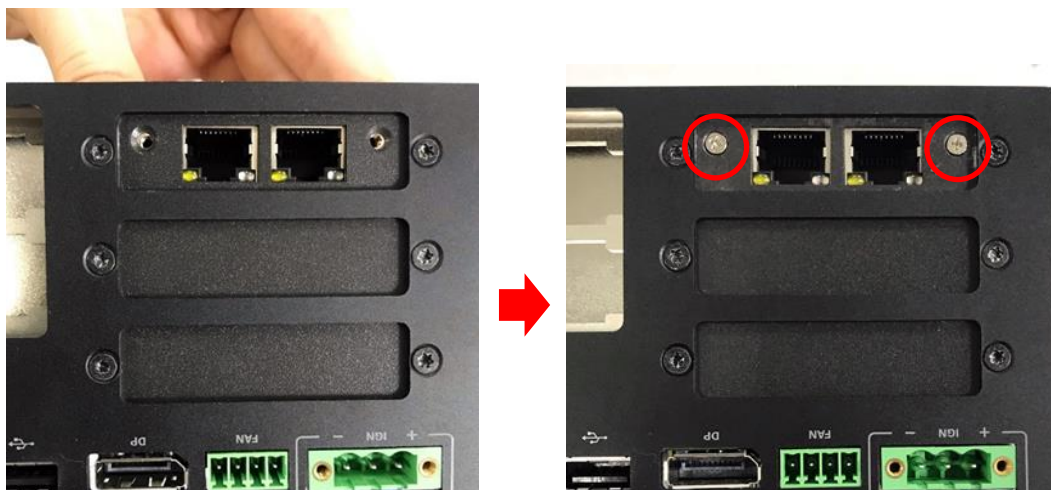

6.6 Installing External FAN

Model No.	Product Description
FAN-EX101	External Fan with 4pin Terminal Block Plug, Mounting Bracket. Support Smart Fan Function

1. Prepare an external fan. Loosen the 2 screws halfway on mounting frame before attempting to install it.



2. Slide the FAN into the middle groove of chassis as illustrated. Tighten the 2 screws to fix it onto chassis.

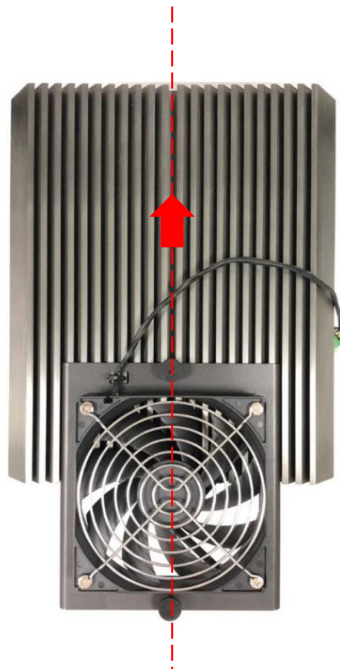

3. Move the fan to the center of chassis. Tighten the 2 screws marked on photo to secure it.

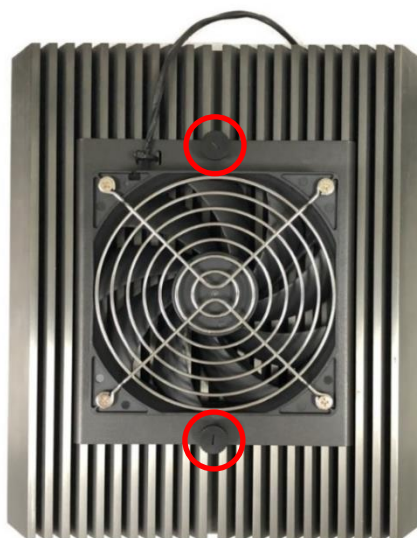

4. Connect the FAN cable to external fan power connector at rear panel.



6.7 Installing Internal FAN (For DS-1302 only)

Model No.	Product Description
FAN-UB100	Exhaling Fan with 4pin Connector, Universal Bracket
FAN-UB101	Inhaling Fan with 4pin Connector, Universal Bracket

1. Unscrew 6 screws to remove 3 I/O brackets from rear panel.

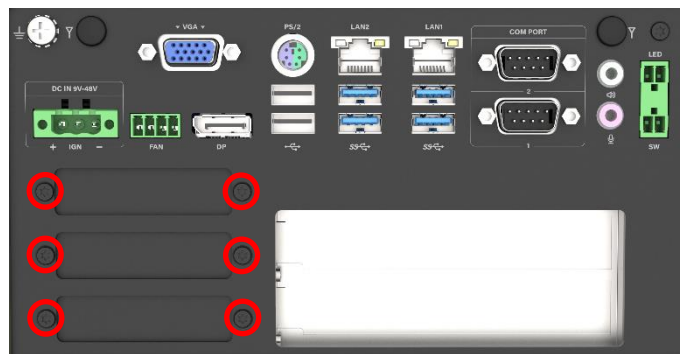

2. Insert the fan connector to the power connector (power4).

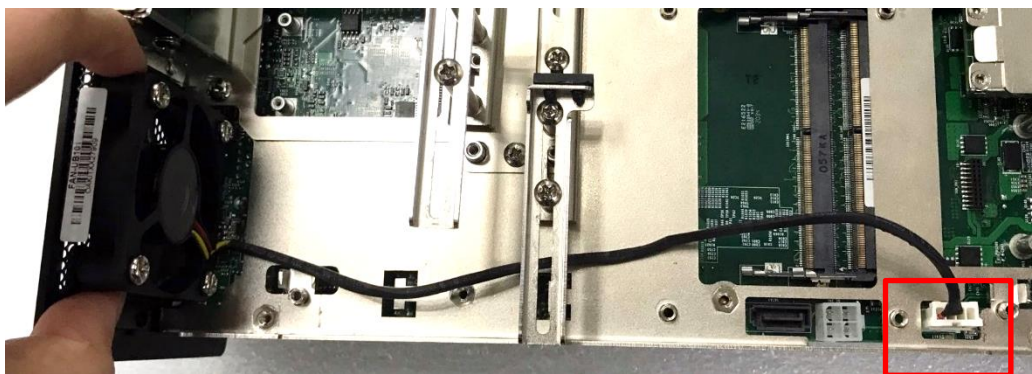

3. Attach the FAN from back side of rear panel, and then fasten the 4 screws to fix it.

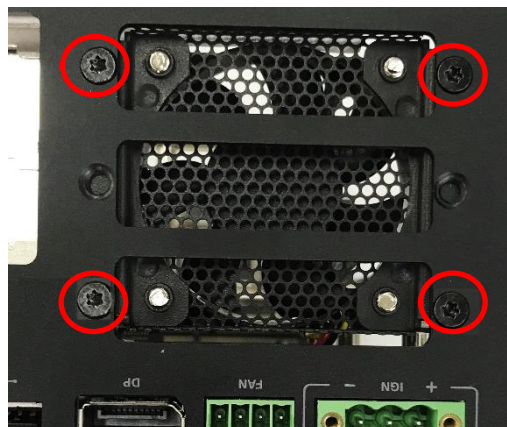

4. User can use cable ties to tie the wire from the cut holes as indicated.

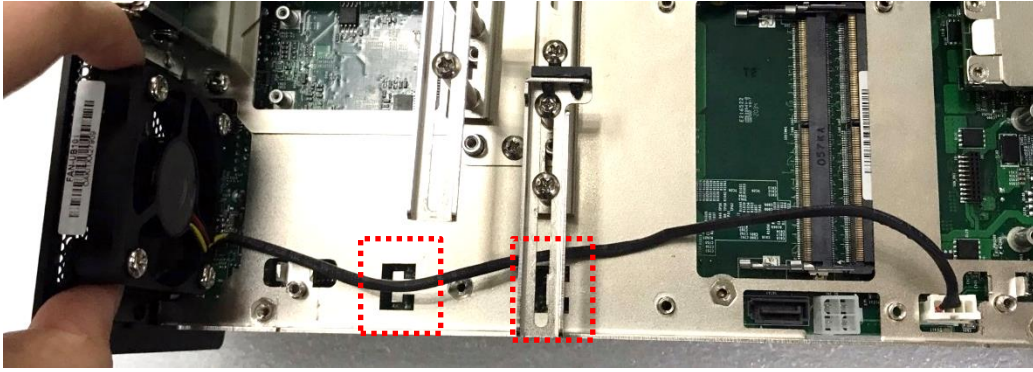

CINCOZE

© 2021 Cincoze Co., Ltd. All rights reserved.

The Cincoze logo is a registered trademark of Cincoze Co., Ltd.

All other logos appearing in this catalog are the intellectual property of the respective company, product, or organization associated with the logo.

All product specifications and information are subject to change without notice.