

***CHCOZE***

# CO-W124C (CO-100 Series)

## User Manual



**Open Frame Panel**  
24" TFT-LCD Open Frame Display Module

# Contents

Preface .....	3
Revision .....	3
Copyright Notice .....	3
Acknowledgement .....	3
Disclaimer.....	3
Declaration of Conformity.....	3
Product Warranty Statement .....	4
Limitation of Liability.....	5
Technical Support and Assistance .....	5
Conventions Used in this Manual .....	6
Safety Precautions.....	6
Package Contents .....	7
Ordering Information .....	7
Chapter 1 Product Introductions .....	8
1.1 Overview .....	9
1.2 Highlights.....	9
1.3 Key Features .....	10
1.4 Hardware Specification .....	11
1.4.1 CO-W124C.....	11
Chapter 2 System Setup.....	13
2.1 Connecting to PC or Monitor Module.....	14
2.2 Standard Mount .....	16
2.2.1 Fixing from front side.....	17
2.2.2 Fixing from rear side .....	18
2.3 Flat Mount.....	19
2.3.1 Fixing from front side.....	23
2.3.2 Fixing from rear side .....	24



device, pursuant to Part 15 of the FCC Rules. These limits are designed to provide reasonable protection against harmful interference when the equipment is operated in a commercial environment. This equipment generates, uses, and can radiate radio frequency energy and, if not installed and used in accordance with the instruction manual, may cause harmful interference to radio communications. Operation of this equipment in a residential area is likely to cause harmful interference in which case the user will be required to correct the interference at his own expense.



#### **CE**

The product(s) described in this manual complies with all application European Union (CE) directives if it has a CE marking. For computer systems to remain CE compliant, only CE-compliant parts may be used. Maintaining CE compliance also requires proper cable and cabling techniques.

## **Product Warranty Statement**

### **Warranty**

Cincoze products are warranted by Cincoze Co., Ltd. to be free from defect in materials and workmanship for 2 years (2 Years for PC Module, 1 Year for Display Module) from the date of purchase by the original purchaser. During the warranty period, we shall, at our option, either repair or replace any product that proves to be defective under normal operation. Defects, malfunctions, or failures of the warranted product caused by damage resulting from natural disasters (such as by lightning, flood, earthquake, etc.), environmental and atmospheric disturbances, other external forces such as power line disturbances, plugging the board in under power, or incorrect cabling, and damage caused by misuse, abuse, and unauthorized alteration or repair, and the product in question is either software, or an expendable item (such as a fuse, battery, etc.), are not warranted.

### **RMA**

Before sending your product in, you will need to fill in Cincoze RMA Request Form and obtain an RMA number from us. Our staff is available at any time to provide you with the most friendly and immediate service.

#### **■ RMA Instruction**

- Customers must fill in Cincoze Return Merchandise Authorization (RMA) Request Form and obtain an RMA number prior to returning a defective product to Cincoze for service.
- Customers must collect all the information about the problems encountered and note anything abnormal and describe the problems on the “Cincoze Service Form” for the RMA number apply process.

- Charges may be incurred for certain repairs. Cincoze will charge for repairs to products whose warranty period has expired. Cincoze will also charge for repairs to products if the damage resulted from acts of God, environmental or atmospheric disturbances, or other external forces through misuse, abuse, or unauthorized alteration or repair. If charges will be incurred for a repair, Cincoze lists all charges, and will wait for customer's approval before performing the repair.
- Customers agree to ensure the product or assume the risk of loss or damage during transit, to prepay shipping charges, and to use the original shipping container or equivalent.
- Customers can be sent back the faulty products with or without accessories (manuals, cable, etc.) and any components from the system. If the components were suspected as part of the problems, please note clearly which components are included. Otherwise, Cincoze is not responsible for the devices/parts.
- Repaired items will be shipped along with a "Repair Report" detailing the findings and actions taken.

### **Limitation of Liability**

Cincoze' liability arising out of the manufacture, sale, or supplying of the product and its use, whether based on warranty, contract, negligence, product liability, or otherwise, shall not exceed the original selling price of the product. The remedies provided herein are the customer's sole and exclusive remedies. In no event shall Cincoze be liable for direct, indirect, special or consequential damages whether based on contract of any other legal theory.

### **Technical Support and Assistance**

1. Visit the Cincoze website at [www.cincoze.com](http://www.cincoze.com) where you can find the latest information about the product.
2. Contact your distributor or our technical support team or sales representative for technical support if you need additional assistance. Please have following information ready before you call:
  - Product name and serial number
  - Description of your peripheral attachments
  - Description of your software (operating system, version, application software, etc.)
  - A complete description of the problem
  - The exact wording of any error messages

## Conventions Used in this Manual



**WARNING**  
(AVERTIR)

This indication alerts operators to an operation that, if not strictly observed, may result in severe injury.

(Cette indication avertit les opérateurs d'une opération qui, si elle n'est pas strictement observée, peut entraîner des blessures graves.)



**CAUTION**  
(ATTENTION)

This indication alerts operators to an operation that, if not strictly observed, may result in safety hazards to personnel or damage to equipment.

(Cette indication avertit les opérateurs d'une opération qui, si elle n'est pas strictement observée, peut entraîner des risques pour la sécurité du personnel ou des dommages à l'équipement.)



**NOTE**  
(NOTE)

This indication provides additional information to complete a task easily.

(Cette indication fournit des informations supplémentaires pour effectuer facilement une tâche.)

## Safety Precautions

Before installing and using this device, please note the following precautions.

1. Read these safety instructions carefully.
2. Keep this User's Manual for future reference.
3. Disconnect this equipment from any AC outlet before cleaning.
4. For plug-in equipment, the power outlet socket must be located near the equipment and must be easily accessible.
5. Keep this equipment away from humidity.
6. Put this equipment on a reliable surface during installation. Dropping it or letting it fall may cause damage.
7. Make sure the voltage of the power source is correct before connecting the equipment to the power outlet.
8. Use a power cord that has been approved for using with the product and that it matches the voltage and current marked on the product's electrical range label. The voltage and current rating of the cord must be greater than the voltage and current rating marked on the product.
9. Position the power cord so that people cannot step on it. Do not place anything over the power cord.
10. All cautions and warnings on the equipment should be noted.
11. If the equipment is not used for a long time, disconnect it from the power source to avoid damage by transient overvoltage.
12. Never pour any liquid into an opening. This may cause fire or electrical shock.

13. Never open the equipment. For safety reasons, the equipment should be opened only by qualified service personnel.

If one of the following situations arises, get the equipment checked by service personnel:

- The power cord or plug is damaged.
- Liquid has penetrated into the equipment.
- The equipment has been exposed to moisture.
- The equipment does not work well, or you cannot get it work according to the user's manual.
- The equipment has been dropped and damaged.
- The equipment has obvious signs of breakage.

14. CAUTION: Risk of Explosion if Battery is replaced by an Incorrect Type. Dispose of Used Batteries According to the Instructions.

ATTENTION: Risque d'explosion si la batterie est remplacée par un type incorrect. Mettre au rebus les batteries usagées selon les instructions.

15. Equipment intended only for use in a RESTRICTED ACCESS AREA.

16. Ensure to connect the power cord of power adapter to a socket-outlet with earthing connection.

17. Dispose of used battery promptly. Keep away from children. Do not disassemble and do not dispose of in fire.

## Package Contents

Before installation, please ensure all the items listed in the following table are included in the package.

### CO-W124C-R10

Item	Description	Q'ty
1	CO-W124C Display Module	1

*Note: Notify your sales representative if any of the above items are missing or damaged.*

## Ordering Information

### Display Module with Projected Capacitive Touch

Model No.	Product Description
CO-W124C-R10	24" TFT-LCD Full HD 16:9 Open Frame Display Module with Projected Capacitive Touch



# **Chapter 1**

## **Product Introductions**

## 1.1 Overview

Cincoze open frame display modules (CO-100 series) use our patented CDS (Convertible Display System) technology to connect with a computer module (P2000 or P1000 series) to form an industrial panel PC or connect with a monitor module (M1100 series) to form an industrial touch monitor. Designed for equipment manufacturers, easy installation is the main advantage of the CO-100. The integrated structure, exclusive adjustable mounting bracket, and support for various mounting methods enable a perfect fit in cabinets of different materials and thicknesses. The robust design also meets the application needs of harsh industrial environments.

## 1.2 Highlights

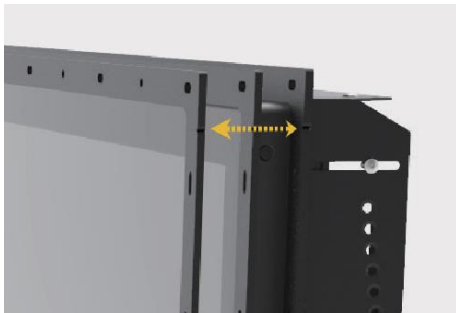

### Flexible Design and Easy Installation

The CO-100 series includes the exclusive adjustable mounting bracket with thickness adjustment setting, as well as panel and boss type locking. Flat and standard mount options make integration in industrial machinery easy and convenient.

Patent No. I802427, D224544, D224545

### Integrated Structure

The CO-100 series is flexible and reliable. As standard, the open frame display module can be deployed in equipment machines, but remove the mounting bracket and it becomes a standalone display module for use with a VESA mount or in a 19" rack.





## Strong, Reliable and Durable

The CO-100 series integrated structure design enables wide temperature support (0–70°C) in addition to front IP65 dustproof and waterproof protection, meeting HMI application requirements.

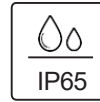
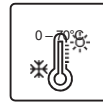

## Highly Adaptable CDS Design

Through the patented CDS technology, the CO-100 can be combined with a computer module to become an industrial panel PC, or with a monitor module to become an industrial touch monitor. Easy maintenance and upgrade flexibility are its main advantages.

Patent No. M482908

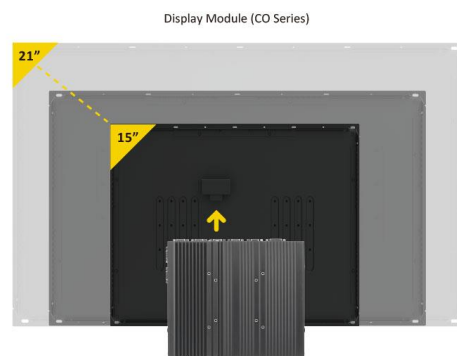

## 1.3 Key Features

- 24" TFT-LCD with Projected Capacitive Touch
- Designed with Adjustable Mounting Bracket
- Support Flat / Standard / VESA / Rack Mount
- Front Panel IP65 Compliant
- Wide Operating Temperature
- Cincoze Patent CDS Technology Support

# 1.4 Hardware Specification

## 1.4.1 CO-W124C

Model Name	CO-W124C
<b>Display</b>	
LCD Size	• 24" (16:9)
Resolution	• 1920 x 1080
Brightness (cd/m2)	• 300
Contrast Ratio	• 5000:1
LCD Color	• 16.7M
Pixel Pitch (mm)	• 0.27675(H) x 0.27675(V)
Viewing Angle	• 178 (H) / 178 (V)
Backlight MTBF	• 50,000 hrs (LED Backlight)
<b>Touchscreen</b>	
Touchscreen Type	• Projected Capacitive Touch
Wet Touch Tracking	✓
<b>Physical</b>	
Dimension (WxDxH)	• 604 x 387.2 x 63.3mm
Weight	• 8.3 KG
Construction	• One-piece and Slim Bezel Design
Mounting Type	• Flat / Standard / VESA / Rack Mount
Mounting Bracket	• Pre-installed Mounting Bracket with Adjustable Design ( Support 11 different stages of adjustment)
<b>Power</b>	
Power Consumption	• 23.75W(Max.)
<b>Protection</b>	
Ingress Protection	• Front Panel IP65 Compliant * According to IEC60529
<b>Environment</b>	
Operating Temperature	• -20°C to 70°C (-4°F to 158°F) (with Industrial Grade peripherals; Ambient with air flow)
Storage Temperature	• -30°C to 80°C (-22°F to 176°F)
Relative Humidity	• 90% RH @ 40°C (non-condensing)
EMC	• CE, UKCA, FCC, ICES-003 Class A
EMI	• CISPR 32 Conducted & Radiated: Class A • EN/BS EN 55032 Conducted & Radiated: Class A • EN/BS EN IEC 61000-3-2 Harmonic current emissions: Class A

	<ul style="list-style-type: none"> <li>• EN/BS EN61000-3-3 Voltage fluctuations &amp; flicker</li> <li>• FCC 47 CFR Part 15B, ICES-003 Conducted &amp; Radiated: Class A</li> </ul>
EMS	<ul style="list-style-type: none"> <li>• EN/IEC 61000-4-2 ESD: Contact: 4 kV; Air: 8 kV</li> <li>• EN/IEC 61000-4-3 RS: 80 MHz to 1000 MHz: 3 V/m</li> <li>• EN/IEC 61000-4-4 EFT: AC Power: 1 kV; DC Power: 0.5 kV; Signal: 0.5 kV</li> <li>• EN/IEC 61000-4-5 Surges: AC Power: 2 kV; Signal: 1 kV</li> <li>• EN/IEC 61000-4-6 CS: 3V</li> <li>• EN/IEC 61000-4-8 PFMF: 50 Hz, 1A/m</li> <li>• EN/IEC 61000-4-11 Voltage Dips &amp; Voltage Interruptions: 0.5 cycles at 50 Hz</li> </ul>

*\* Product Specifications and features are for reference only and are subject to change without prior notice. For more information, please refer to the latest product datasheet from Cincoze's website.*

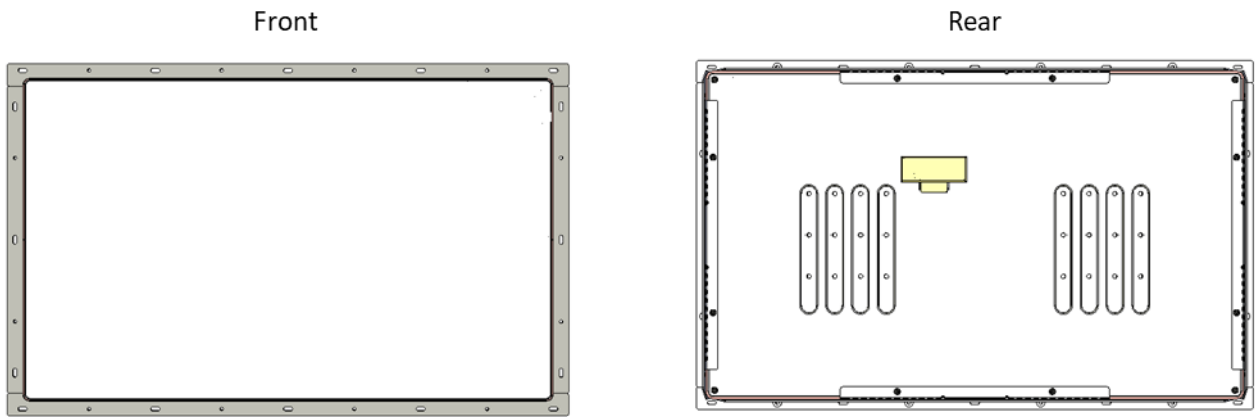

### External Layout

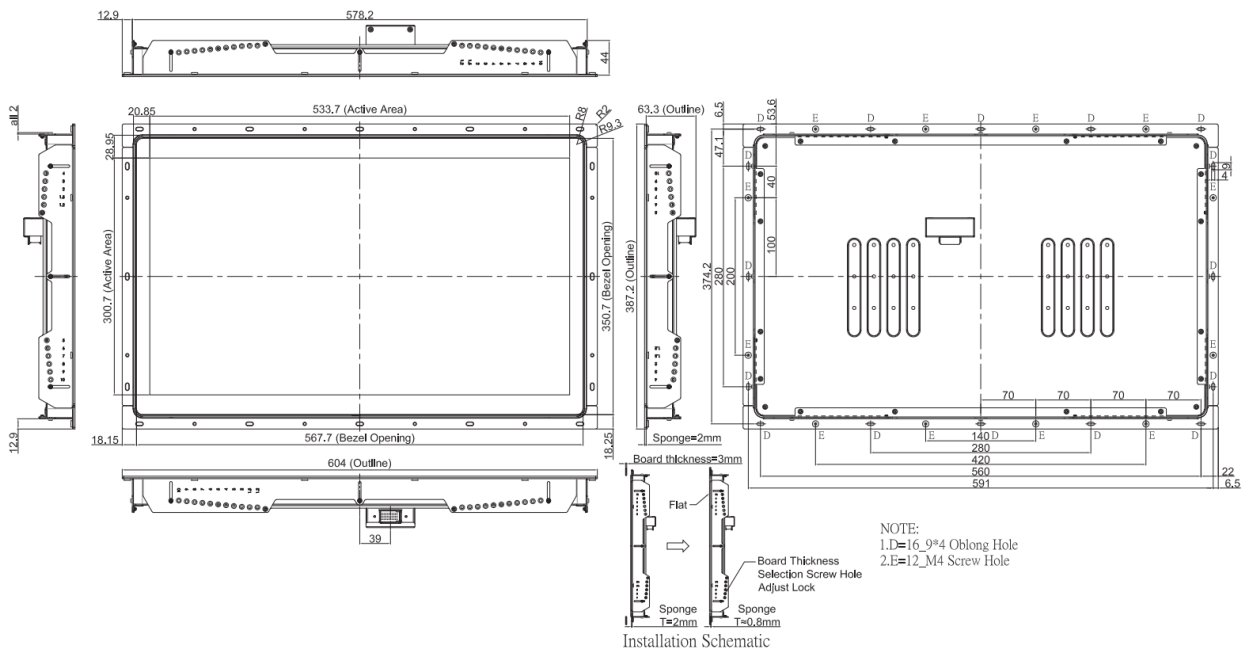

### Dimension

Unit: mm

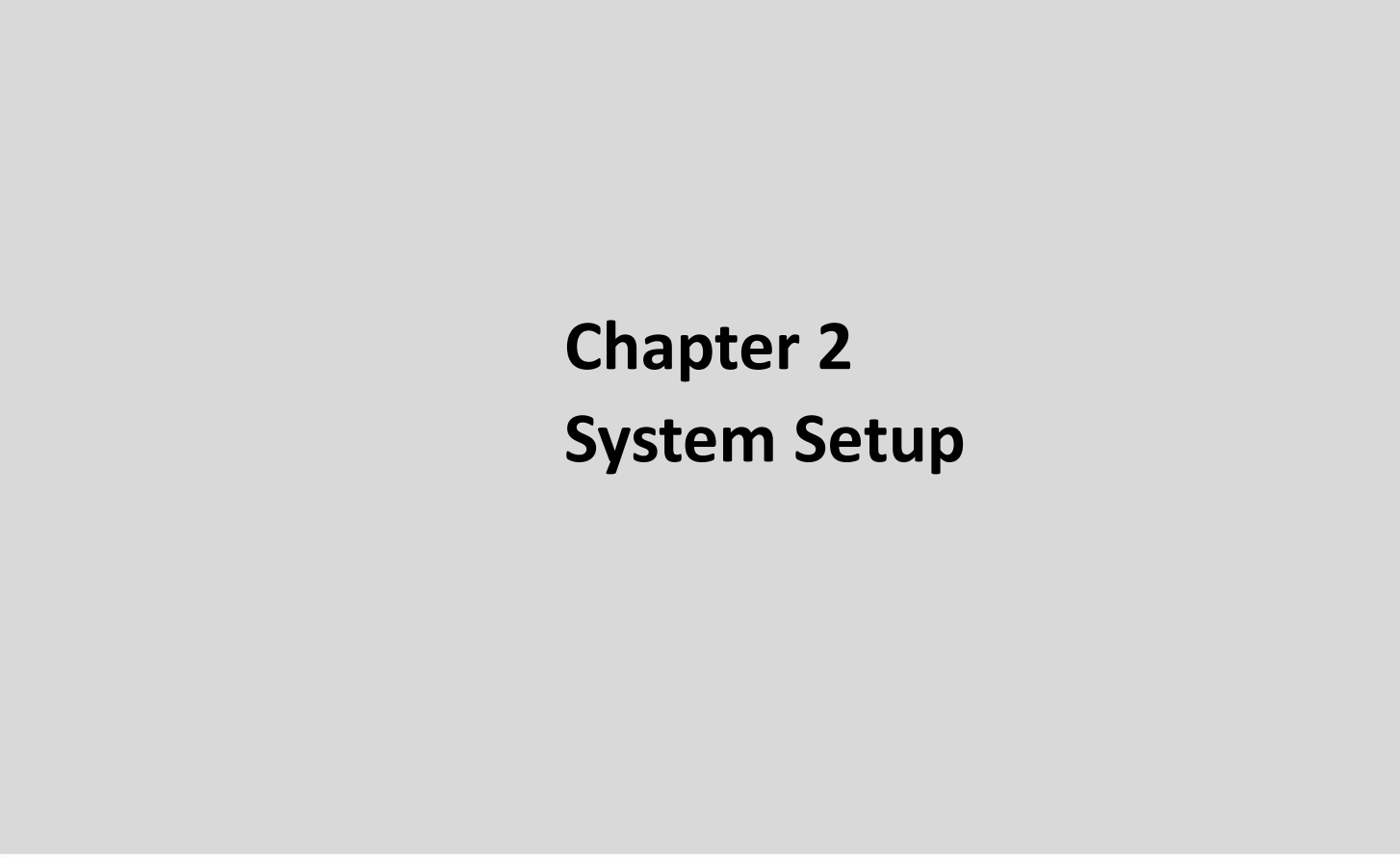



# **Chapter 2**

## **System Setup**

## 2.1 Connecting to PC or Monitor Module



**WARNING**  
**(AVERTIR)**

In order to prevent electric shock or system damage, must turn off power and disconnect the unit from power source before removing the chassis cover.

(Afin d'éviter tout risque d'électrocution ou d'endommagement du système, vous devez couper l'alimentation et débrancher l'appareil de la source d'alimentation avant de retirer le couvercle du châssis.)

Step 1. Locate the male connector on the display module and the female connector on the PC or monitor module. (Please assemble the wall mount brackets and remove the CDS cover plate on the PC or monitor module first according to its user manual.)



**PC module**



**Monitor module**

Step 2. Connect the modules.

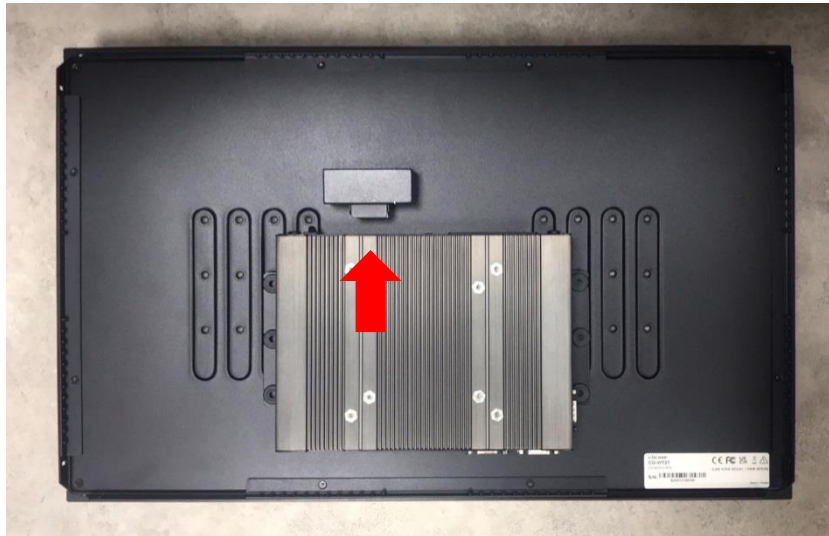

Step 3. Fasten the 6 screws to fix the PC module or monitor module on the display module.

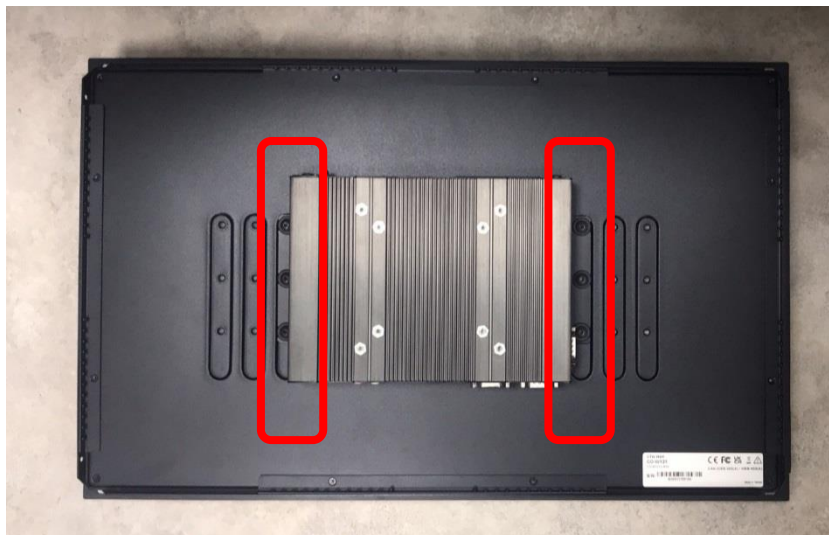

## 2.2 Standard Mount

The CO-100 series includes various mounting bracket designs, and this section demonstrates the CO-W124C installation process.

Before starting the following steps, ensure the screws are secured in the default positions, as shown below. These positions are correct for Standard Mount, so no additional adjustments are necessary.



CO-W124C Top Side View



CO-W124C Bottom Side View



CO-W124C Left Side View



CO-W124C Right Side View

Step 1. Put the module onto the cabinet's back side.



There are two methods for fastening the module onto the cabinet to complete the standard mount. One is to fix the module from the front side of the cabinet, which is illustrated in chapter 2.2.1. The other one is to fix the module from the rear side of the cabinet, which is illustrated in chapter 2.2.2.

### 2.2.1 Fixing from front side

Step 2. Fasten the screws from the cabinet's front side. Please prepare 12 pcs of M4 screws for fixing the module through the **circle holes** (with screw thread).

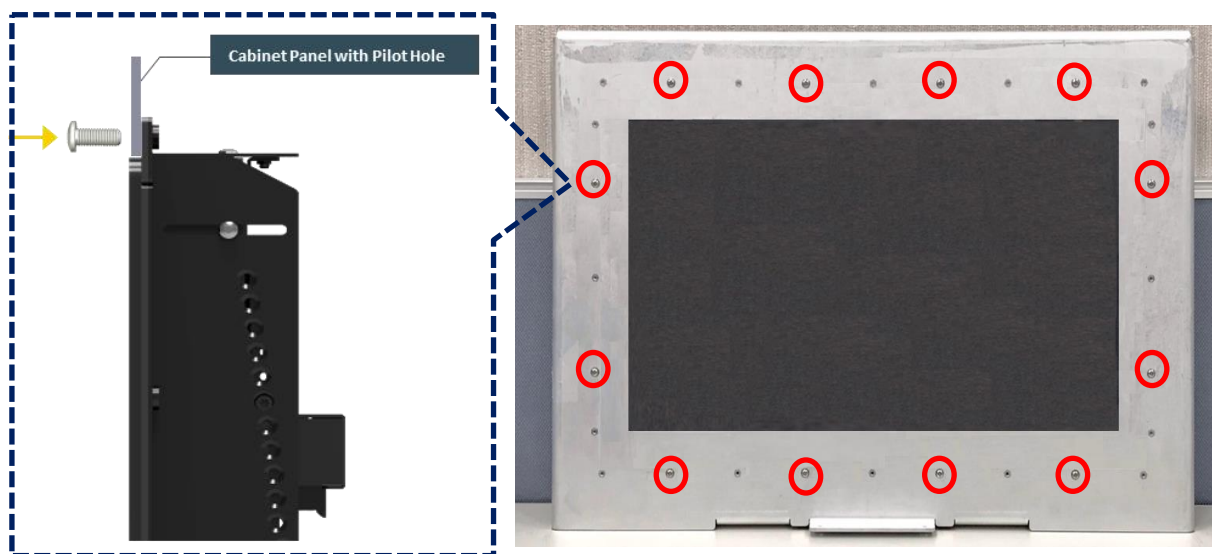

## 2.2.2 Fixing from rear side

Step 2. If the cabinet panel is with stud bolts as the following figure, user can prepare 16 pcs of nuts for fixing the module through the **oblong holes** (oblong hole size: 9mmx4mm, without screw thread).

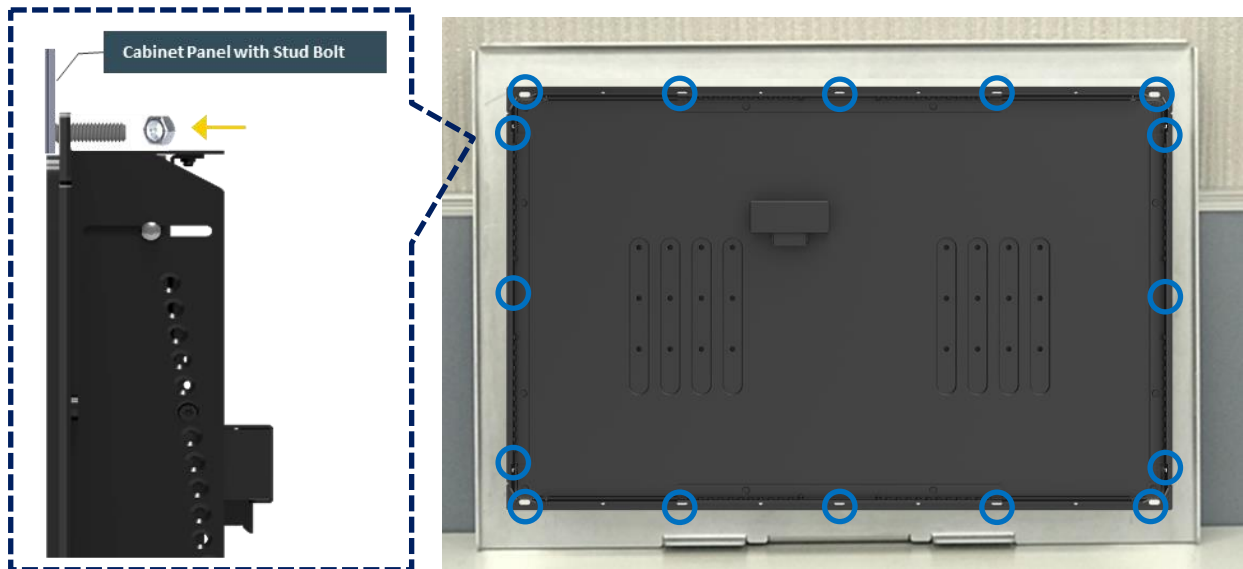

If the cabinet panel is with bosses as the following figures, user can prepare 16 pcs of M4 screws for fixing the module through the **oblong holes** (oblong hole size: 9mmx 4mm, without screw thread).

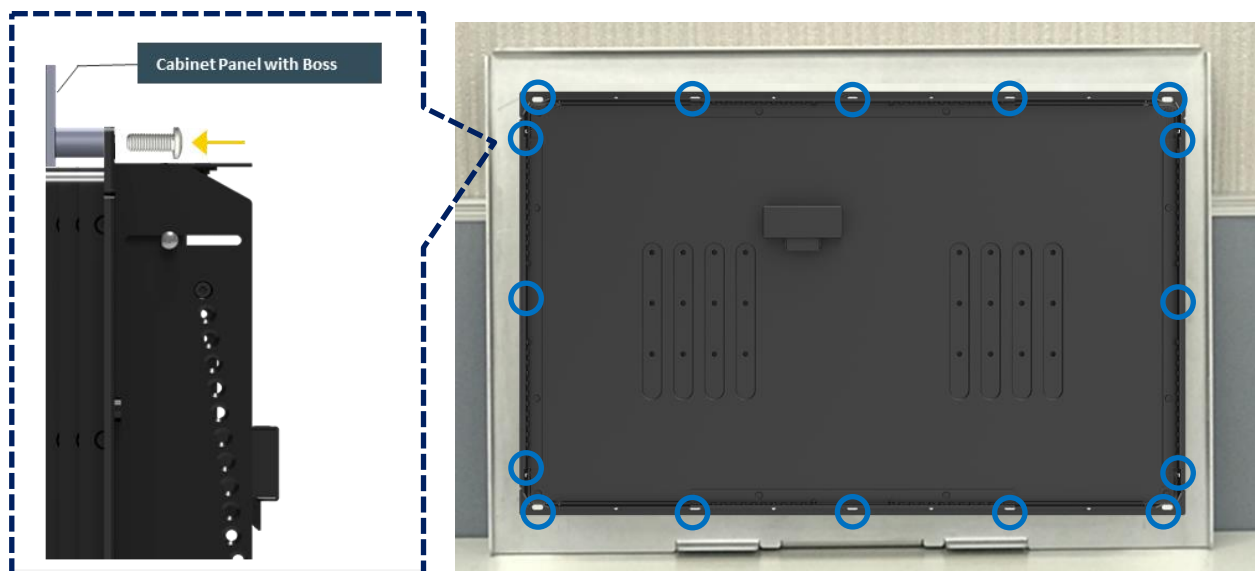

## 2.3 Flat Mount

The CO-100 series includes various mounting bracket designs, and this section demonstrates the CO-W124C installation process.

Step 1. Loosen the screws marked with blue circles on all four sides of the module (Top, Bottom, Left, Right). Then, remove the positioning screws marked with red circles, as shown in the four images below.



CO-W124C Top Side View



CO-W124C Bottom Side View



CO-W124C Left Side View



CO-W124C Right Side View

Step 2. Measure the cabinet or rack thickness. The thickness is measured 3mm in this example.

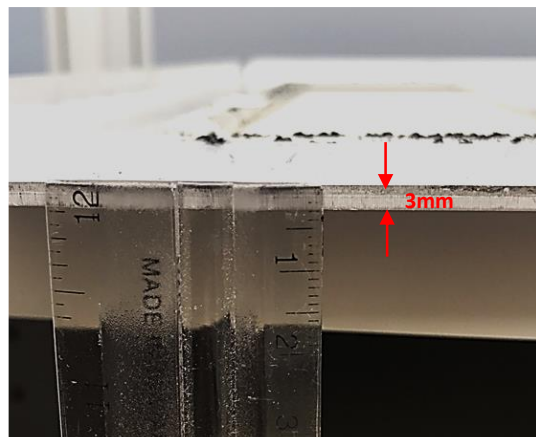

Step 3. Locate the top and bottom-side mounting brackets.

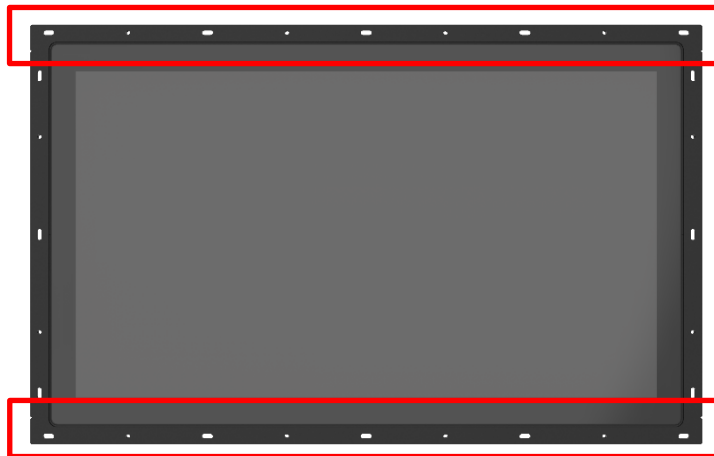

Step 4. According to the thickness = 3mm for the example, push down the top and bottom-side mounting brackets to the place at screw hole = 3mm; and then fasten back the two positioning screws on the top and bottom-side mounting brackets.

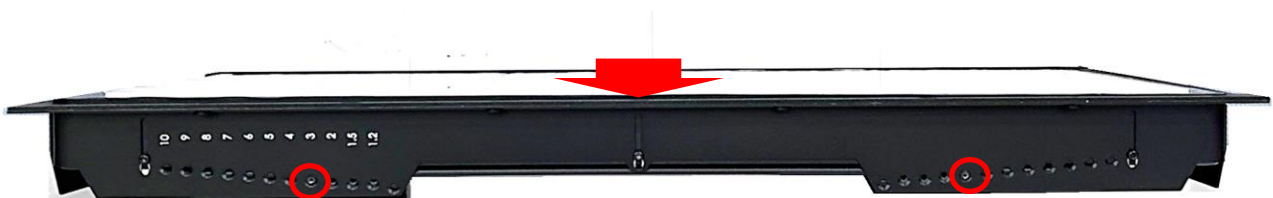

CO-W124C Top Side View

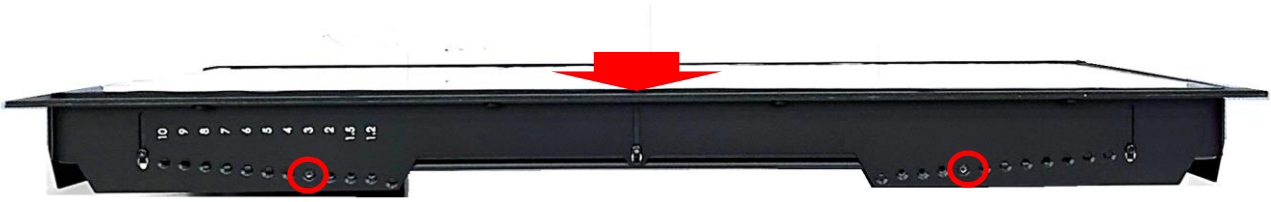

CO-W124C Bottom Side View

Step 5. Fasten the three screws on the top and bottom-side mounting brackets.



CO-W124C Top Side View

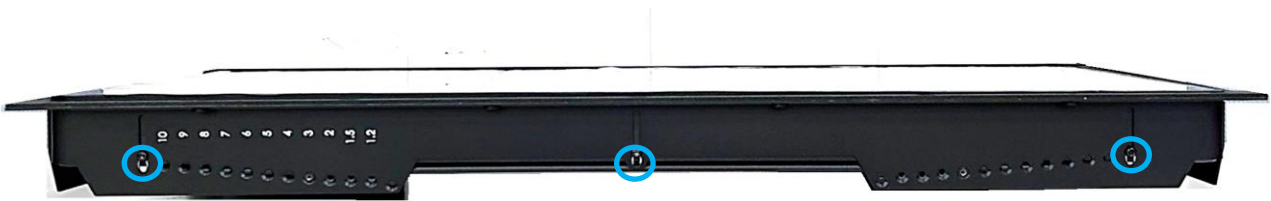

CO-W124C Bottom Side View

Step 6. Locate the left and right-side mounting brackets.



Step 7. According to the thickness = 3mm for the example, push down the left and right-side mounting brackets to the place at screw hole = 3mm; and then fasten back the one positioning screw on the left and right-side mounting brackets.



CO-W124C Left Side View



CO-W124C Right Side View

Step 8. Lift up the left and right-side mounting brackets with aligning the top and bottom-side mounting brackets, then fasten the three screws by the indicated sequence 1, 2, 3 on each side.



CO-W124C Left Side View



CO-W124C Right Side View

Step 9. Put the module onto the cabinet back side.



There are two methods to fasten the module onto the cabinet for a flat mount. The first method involves securing the module from the front side of the cabinet, as shown in Chapter 2.3.1. The second method involves securing it from the rear side, as shown in Chapter 2.3.2.

### 2.3.1 Fixing from front side

Step 10. Fasten the screws from the cabinet's front side. Please prepare 12 pcs of M4 screws for fixing the module through the **circle holes** (with screw thread).

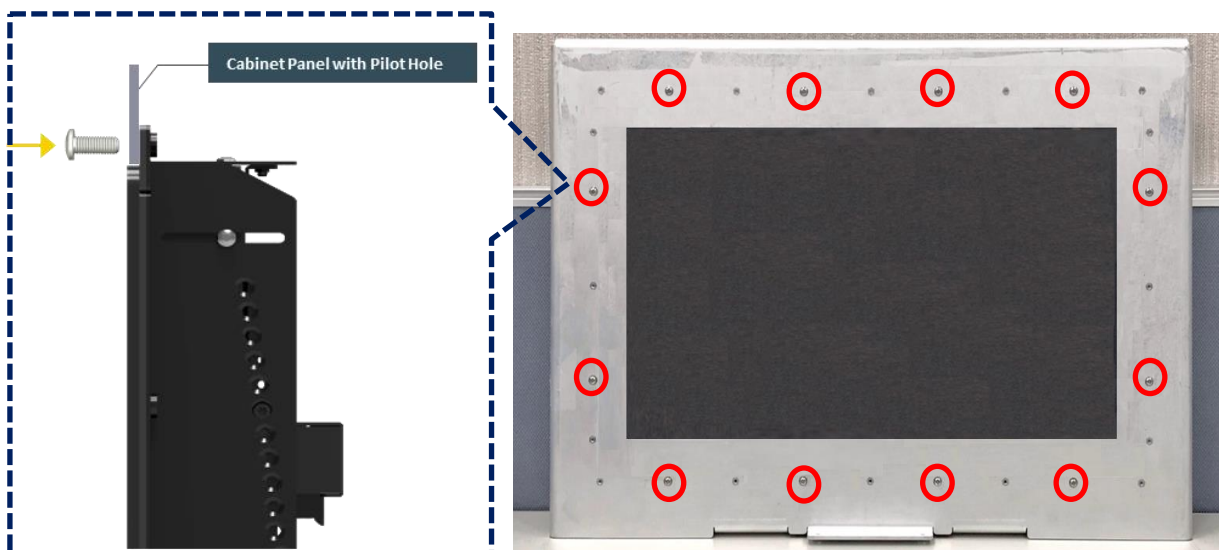

### 2.3.2 Fixing from rear side

Step 10. If the cabinet panel is with stud bolts as the following figure, user can prepare 16 pcs of nuts for fixing the module through the **oblong holes** (oblong hole size: 9mmx4mm, without screw thread).

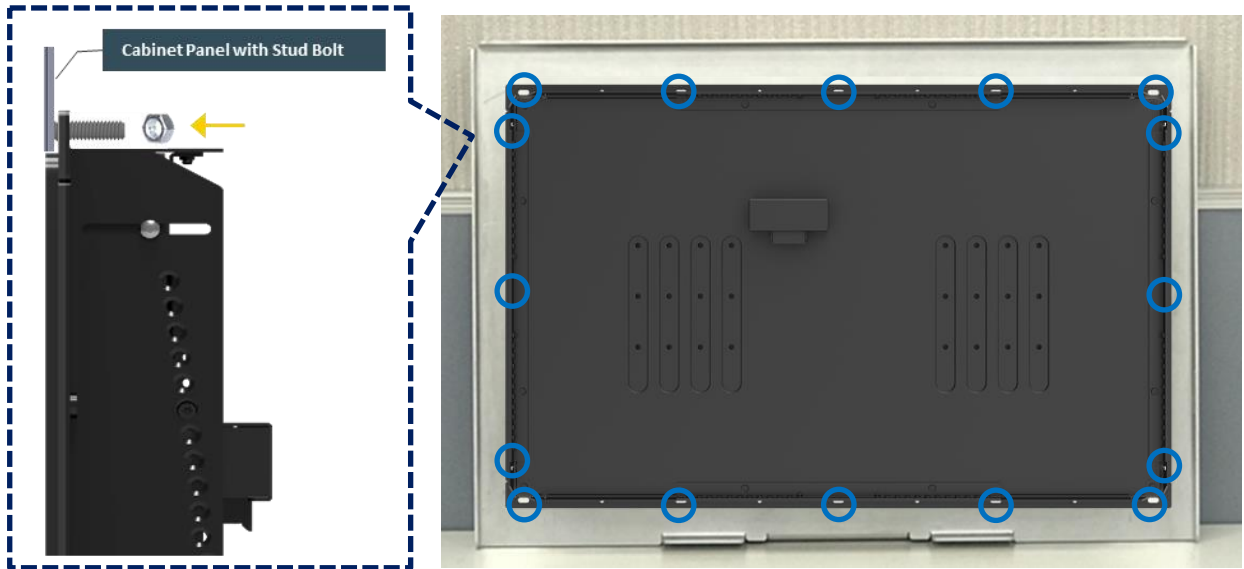

If the cabinet panel is with bosses as the following figures, user can prepare 16 pcs of M4 screws for fixing the module through the **oblong holes** (oblong hole size: 9mmx 4mm, without screw thread).

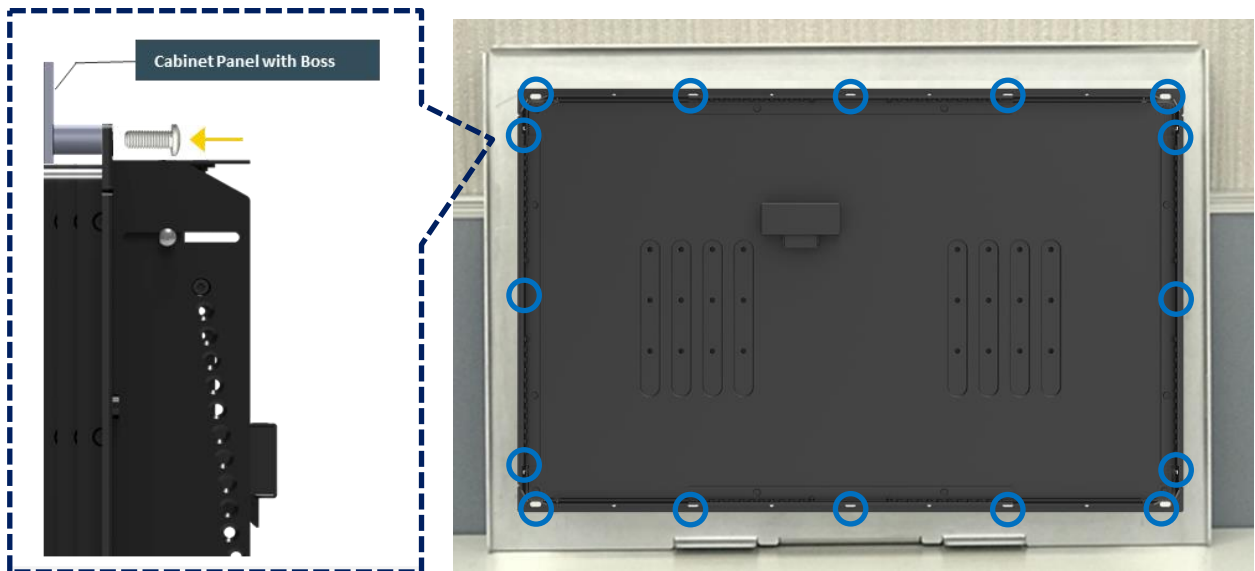

***cincoze***

© 2024 Cincoze Co., Ltd. All rights reserved.

The Cincoze logo is a registered trademark of Cincoze Co., Ltd.

All other logos appearing in this catalog are the intellectual property of the respective company, product, or organization associated with the logo.

All product specifications and information are subject to change without notice.