

Universal Bracket

UB0111

Universal Bracket with 2x RJ45 Cutout
Dimension (WxD) : 65 x 17.4 mm

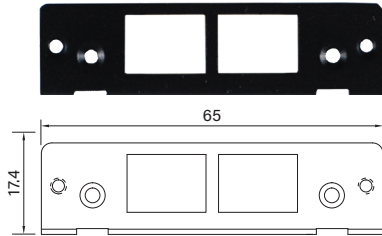

UB0203

2x Universal Bracket with 1x DB9 Cutout
Dimension (WxD) : 53.5 x 21 mm

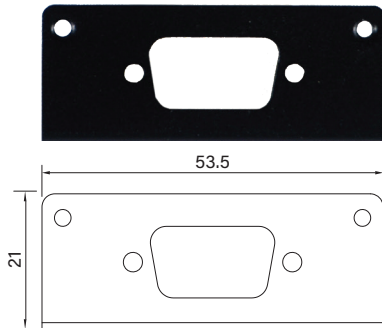

UB0211

Universal Bracket with 2x RJ45 Cutout
Dimension (WxD) : 53.5 x 21 mm

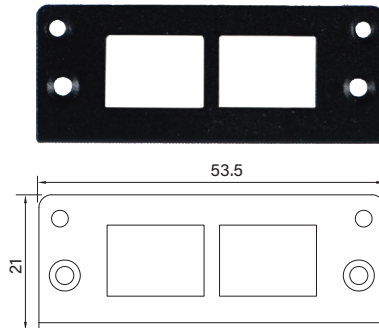

UB0214

Universal Bracket with 2x USB Cutout
Dimension (WxD) : 53.5 x 21 mm

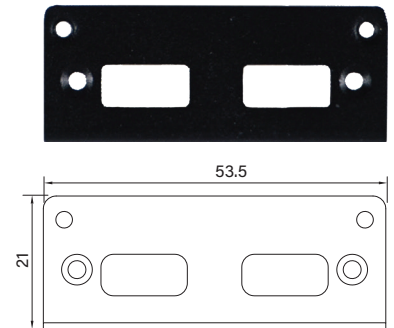

UB0303

Universal Bracket with 1x DB9 Cutout
Dimension (WxD) : 64.6 x 16.4 mm

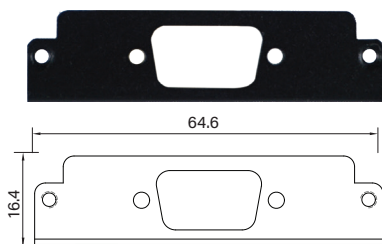

UB0311

Universal Bracket with 2x RJ45 Cutout
Dimension (WxD) : 64.6 x 17.4 mm

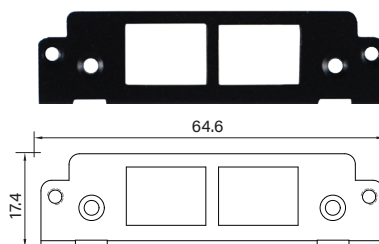

UB0314

Universal Bracket with 2x USB Cutout
Dimension (WxD) : 64.6 x 16.4 mm

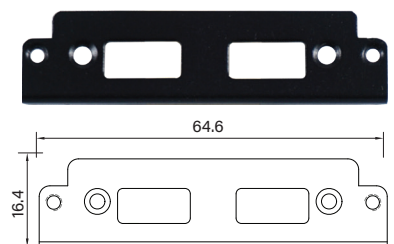

UB0403

Universal Bracket with 2x DB9 Cutout for CMI-COM, MEC-COM & MEC-CAN Expansion
Dimension (WxD) : 96.4 x 15 mm

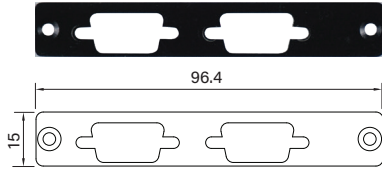

UB0406

Universal Bracket with 1x DP Cutout for CMI-DP Expansion
Dimension (WxD) : 96.4 x 15 mm

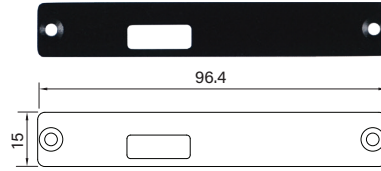

UB0407

Universal Bracket with 1x DVI Cutout for CMI-DVI-D Expansion
Dimension (WxD) : 96.4 x 15 mm

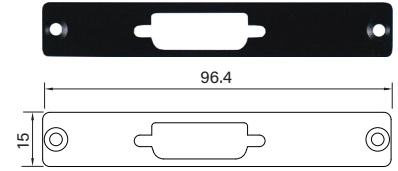

UB0408

Universal Bracket with 1x HDMI Cutout for CMI-HDMI Expansion
Dimension (WxD) : 96.4 x 15 mm

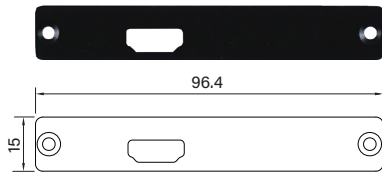

UB0409

Universal Bracket with 1x LPT, 1x PS/2 Cutout for CMI-LPPS Expansion
Dimension (WxD) : 96.4 x 15 mm

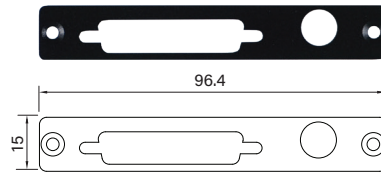

UB0411

Universal Bracket with 2x RJ45 Cutout for MEC-LAN Expansion
Dimension (WxD) : 96.4 x 15 mm

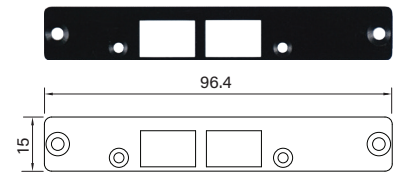

UB0415

Universal Bracket with 1x 10 Pin Terminal Block Cutout for CMI-DIO Expansion
Dimension (WxD) : 96.4 x 15 mm

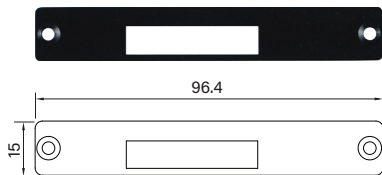

UB0416

Universal Bracket with 1x VGA Cutout for CMI-VGA Expansion
Dimension (WxD) : 96.4 x 15 mm

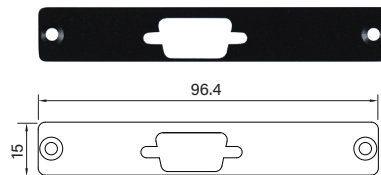

UB0429

Universal Bracket with 2x Antenna Cutout
Dimension (WxD) : 96.4 x 15 mm

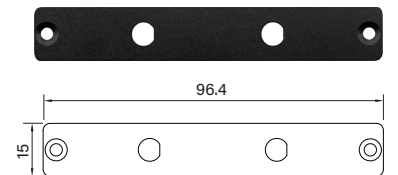

UB0503

Universal Bracket with 2x DB9 Cutout
Dimension (WxD) : 154 x 17.3 mm

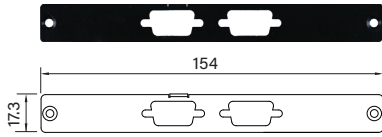

UB0504

Universal Bracket with 4x DB9 Cutout
Dimension (WxD) : 154 x 17.3 mm

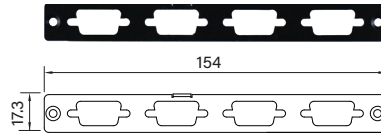

UB0511

Universal Bracket with 2x RJ45 Cutout
Dimension (WxD) : 154 x 17.3 mm

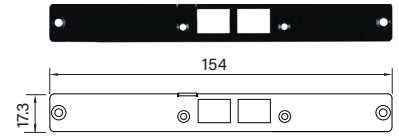

UB0514

Universal Bracket with 2x USB Cutout
Dimension (WxD) : 154 x 17.3 mm

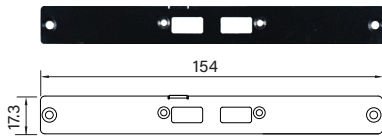

UB0610

Universal Bracket with 4x M12 Cutout
Dimension (WxD) : 81 x 26.2 mm

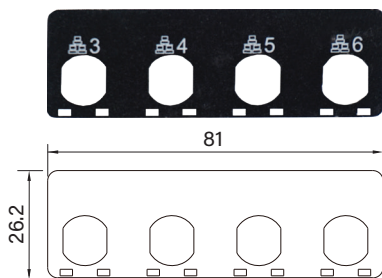

UB0612

Universal Bracket with 4x RJ45 Cutout
Dimension (WxD) : 81 x 26.2 mm

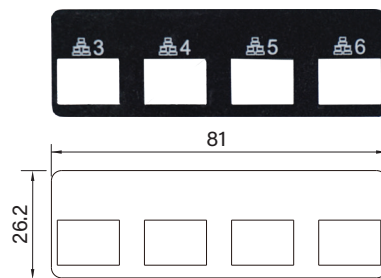

UB0630

Universal Bracket with 4x M12 X-Coded Cutout
Dimension (WxD) : 81 x 26.2 mm

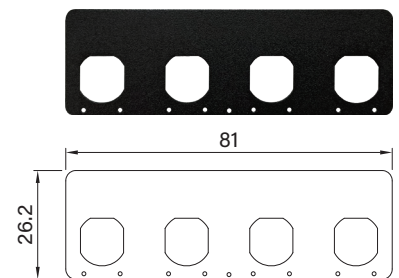

UB0703
Universal Bracket with 2x DB9 Cutout
Dimension (WxD) : 82.5 x 19.5 mm

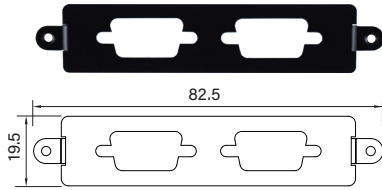

UB0710
Universal Bracket with 4x M12 Cutout
Dimension (WxD) : 82.5 x 19.5 mm

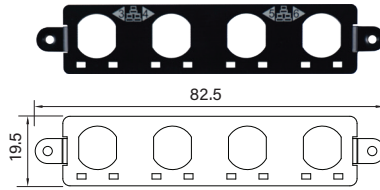

UB0711
Universal Bracket with 2x RJ45 Cutout
Dimension (WxD) : 82.5 x 19.5 mm

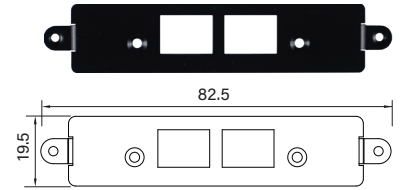

UB0712
Universal Bracket with 4x RJ45 Cutout
Dimension (WxD) : 82.5 x 19.5 mm

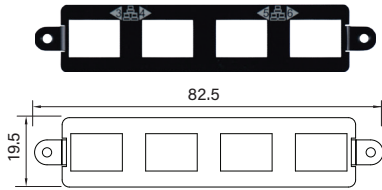

UB0903

Universal Bracket with 2x DB9 Cutout
Dimension (WxD) : 96.95 x 18.4 mm

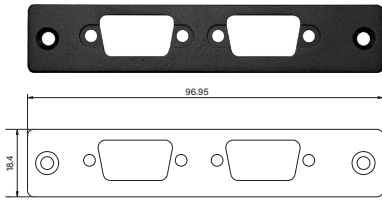

UB0910

Universal Bracket with 4x M12 Cutout
Dimension (WxD) : 96.95 x 18.4 mm

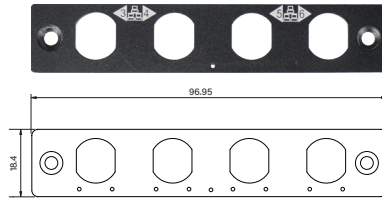

UB0911

Universal Bracket with 4x M12 Cutout
Dimension (WxD) : 96.95 x 18.4 mm

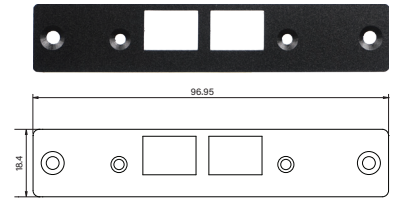

UB0912

Universal Bracket with 4x RJ45 Cutout
Dimension (WxD) : 96.95 x 18.4 mm

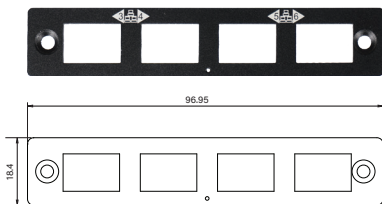

UB0918

Universal Bracket with DIO Cutout
Dimension (WxD) : 96.95 x 18.4 mm

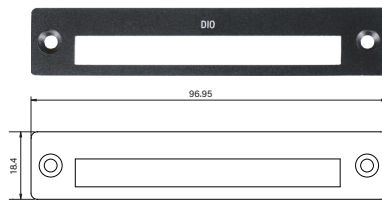

UB0930

Universal Bracket with 4x M12 X-Coded Cutout for DX Series
Dimension (WxD) : 96.95 x 18.4 mm

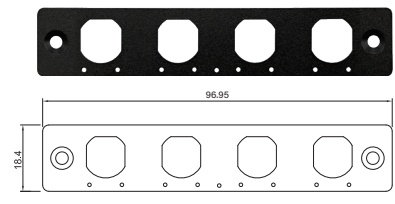

UB0932

Universal Bracket with 3x Antenna Cutout
Dimension (WxD) : 96.95 x 18.4 mm

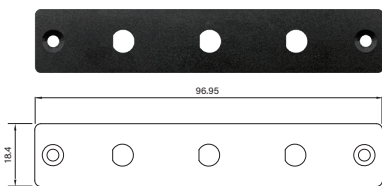

UB1004
Universal Bracket with 4x DB9 Cutout
 Dimension (WxD) : 88.8 x 31 mm

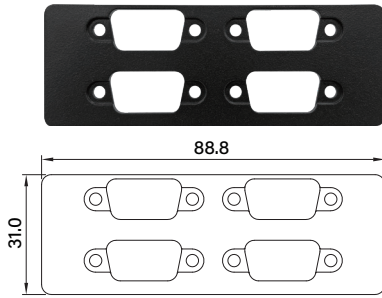

UB1010
Universal Bracket with 4x M12 Cutout
 Dimension (WxD) : 88.8 x 31 mm

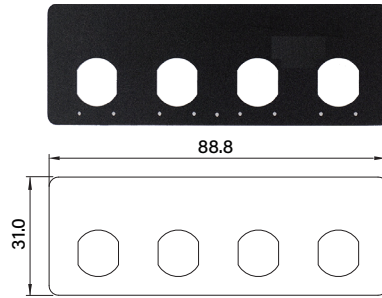

UB1012
Universal Bracket with 4x RJ45 Cutout
 Dimension (WxD) : 88.8 x 31 mm

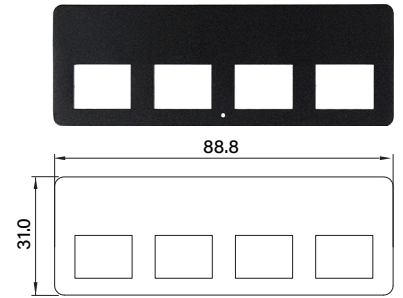

UB1018
Universal Bracket with DIO Cutout
 Dimension (WxD) : 88.8 x 31 mm

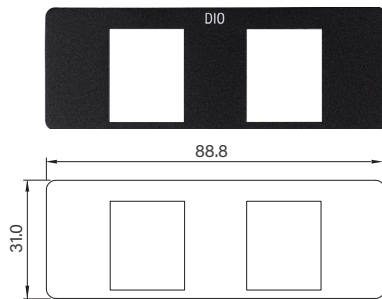

UB1028
Universal Bracket with 2x RJ45 Cutout
 Dimension (WxD) : 88.8 x 31 mm

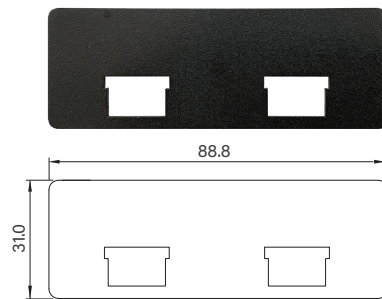

UB1030
Universal Bracket with 4x M12 X-Coded Cutout
 Dimension (WxD) : 88.8 x 31 mm

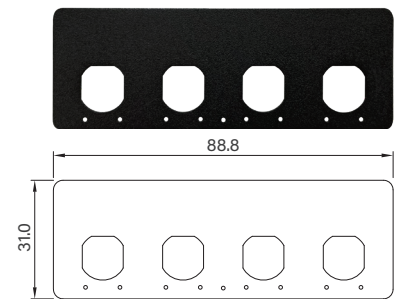

UB1103

Universal Bracket with 2x DB9 Cutout for CMI-COM, MEC-COM & MEC-CAN Expansion
Dimension (WxD) : 80.95 x 15.7 mm

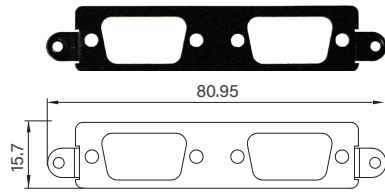

UB1106

Universal Bracket with 1x DP Cutout for CMI-DP Expansion
Dimension (WxD) : 80.95 x 15.7 mm

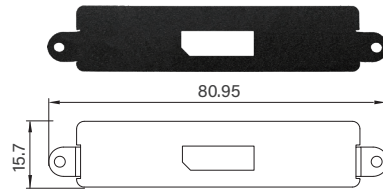

UB1107

Universal Bracket with 1x DVI Cutout for CMI-DVI Expansion
Dimension (WxD) : 80.95 x 15.7 mm

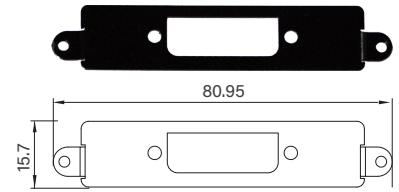

UB1108

Universal Bracket with 1x HDMI Cutout for CMI-HDMI Expansion
Dimension (WxD) : 80.95 x 15.7 mm

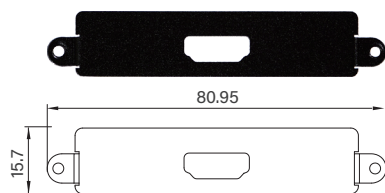

UB1111

Universal Bracket with 2x RJ45 Cutout for MEC-LAN Expansion
Dimension (WxD) : 80.95 x 15.7 mm

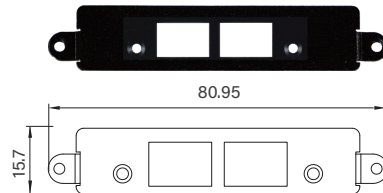

UB1115

Universal Bracket with 1x 10 Pin Terminal Block Cutout for CMI-DIO Expansion
Dimension (WxD) : 80.95 x 15.7 mm

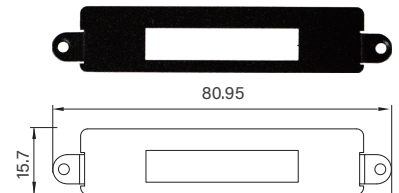

UB1116

Universal Bracket with 1x VGA Cutout for CMI-VGA Expansion
Dimension (WxD) : 80.95 x 15.7 mm

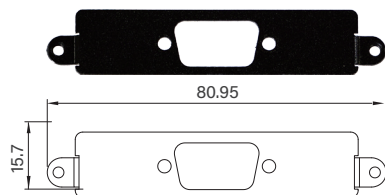

UB1129

Universal Bracket with 2x RJ45 Cutout for DC-1200 Rear Bezel
Dimension (WxD) : 81.6 x 15.7 mm

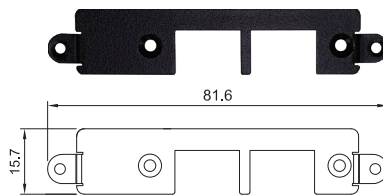

UB1131

Universal Bracket with 2x Antenna Cutout
Dimension (WxD) : 80.95 x 15.7 mm

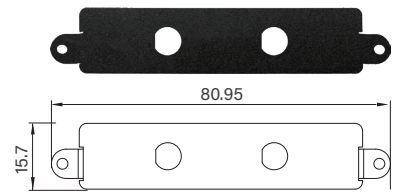

UB1134

Universal Bracket with 2x USB Type A Cutout for MEC-USB (M.2 interface) Expansion
Dimension (WxD) : 80.95 x 15.7 mm

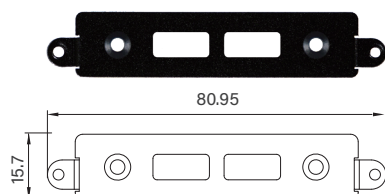

UB1203
Universal Bracket with 2x DB9 Cutout
Dimension (WxD) : 117.9 x 15.9 mm

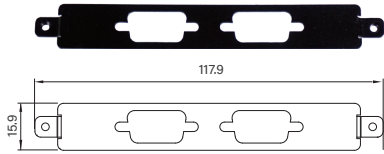

UB1211
Universal Bracket with 2x RJ45 Cutout
Dimension (WxD) : 117.9 x 15.9 mm

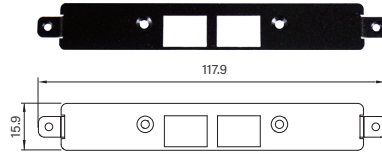

UB1214
Universal Bracket with 2x USB Cutout
Dimension (WxD) : 117.9 x 15.9 mm

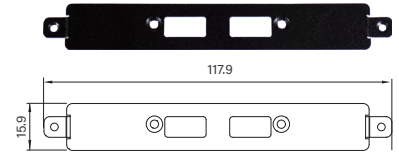

UB1303

Universal Bracket with 2x DB9 Cutout
Dimension (WxD): 96.95 x 18.4 mm

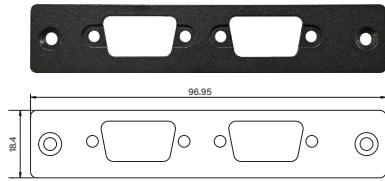

UB1310

Universal Bracket with 4x M12 Cutout
Dimension (WxD): 102.4 x 18.5 mm

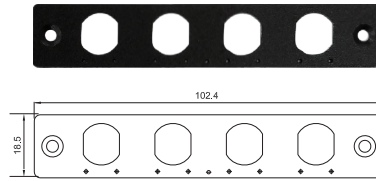

UB1311

Universal Bracket with 2x RJ45 Cutout
Dimension (WxD): 96.95 x 18.4 mm

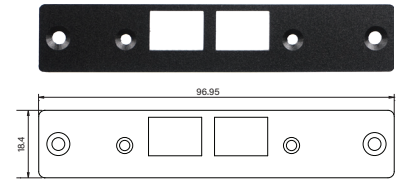

UB1312

Universal Bracket with 4x RJ45 Cutout
Dimension (WxD): 102.4 x 18.5 mm

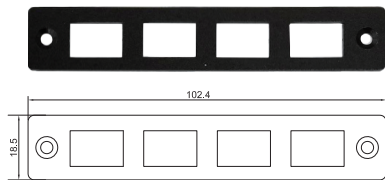

UB1314

Universal Bracket with 2x USB Cutout
Dimension (WxD): 96.95 x 18.4 mm

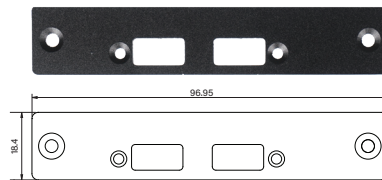

UB1318

Universal Bracket with DIO Cutout
Dimension (WxD): 96.95 x 18.4 mm

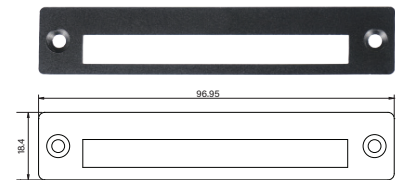

UB1328

Universal Bracket with 2x RJ45 Cutout
Dimension (WxD): 102.4 x 18.5 mm

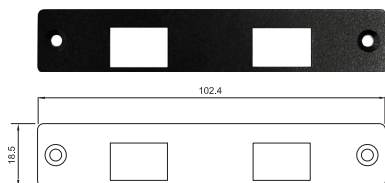

UB1329

Universal Bracket with 4x DP Cutout
Dimension (WxD): 102.4 x 18.5 mm

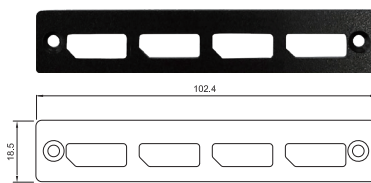

UB1330

Universal Bracket with 4x M12 X-Coded Cutout
Dimension (WxD): 102.4 x 18.5 mm

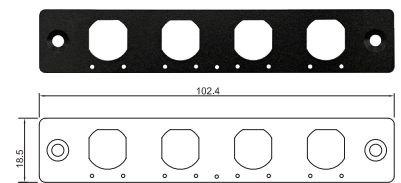

UB1332

Universal Bracket with 3x Antenna Cutout
Dimension (WxD): 102.4 x 18.5 mm

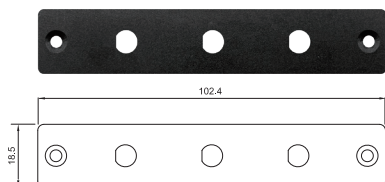

UB1403
Universal Bracket with 4x DB9 Cutout
Dimension (WxD): 98.85 x 25.5 mm

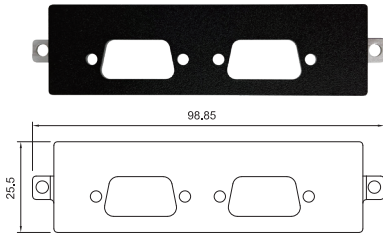

UB1410
Universal Bracket with 4x M12 Cutout
Dimension (WxD): 98.85 x 25.5 mm

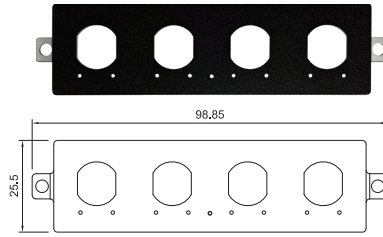

UB1412
Universal Bracket with 4x RJ45 Cutout
Dimension (WxD): 98.85 x 25.5 mm

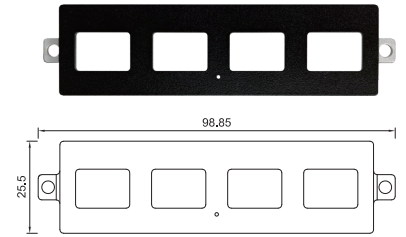

UB1414
Universal Bracket with 2x USB Cutout
Dimension (WxD): 98.85 x 25.5 mm

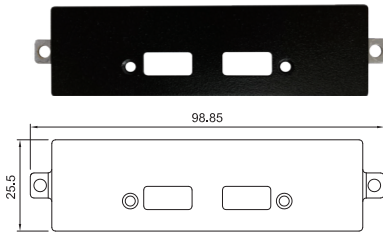

UB1418
Universal Bracket with DIO Cutout
Dimension (WxD): 98.85 x 25.5 mm

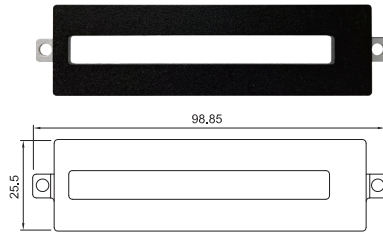

UB1428
Universal Bracket with 2x RJ45 Cutout
Dimension (WxD): 98.85 x 25.5 mm

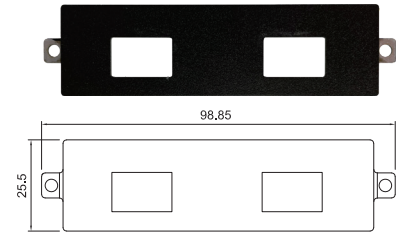

UB1503
Universal Bracket with 2x DB9 Cutout
 Dimension (WxD): 82.5 x 17 mm

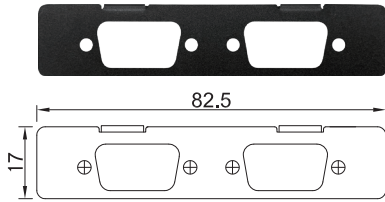

UB1506
Universal Bracket with DisplayPort Cutout
 Dimension (WxD): 82.5 x 17 mm

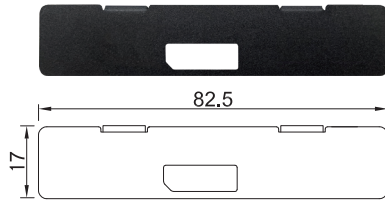

UB1508
Universal Bracket with HDMI Cutout
 Dimension (WxD): 82.5 x 17 mm

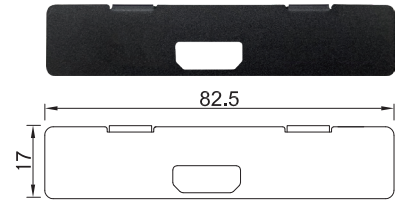

UB1510
Universal Bracket with 4x M12 Cutout
 Dimension (WxD): 82.5 x 17 mm

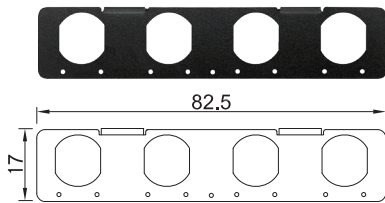

UB1511
Universal Bracket with 2x RJ45 Cutout
 Dimension (WxD): 82.5 x 17 mm

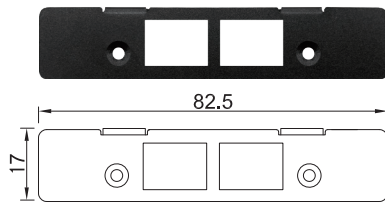

UB1512
Universal Bracket with 4x RJ45 Cutout
 Dimension (WxD): 82.5 x 17 mm

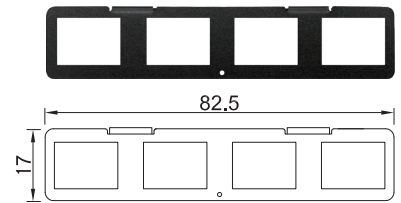

UB1516
Universal Bracket with VGA Cutout
 Dimension (WxD): 82.5 x 17 mm

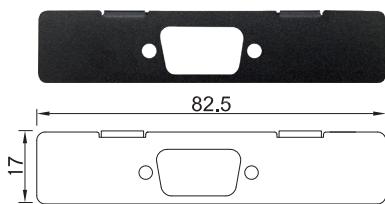

UB1518
Universal Bracket with DIO Cutout
 Dimension (WxD): 82.5 x 17 mm

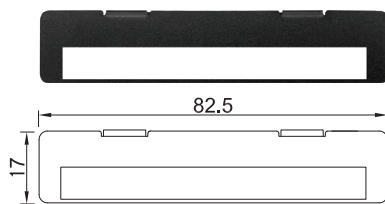

UB1528
Universal Bracket with 2x RJ45 Cutout
 Dimension (WxD): 82.5 x 17 mm

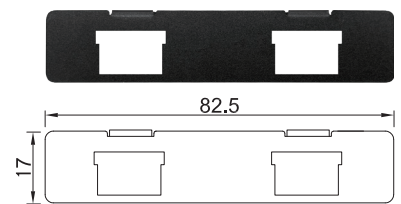

UB1603
Universal Bracket with 2x DB9 Cutout
 Dimension (WxD): 91.5 x 18.5 mm

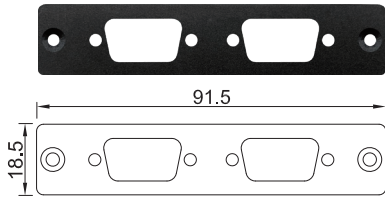

UB1606
Universal Bracket with DP Cutout
 Dimension (WxD): 91.5 x 18.5 mm

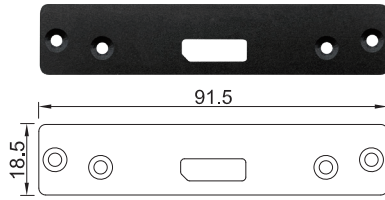

UB1608
Universal Bracket with HDMI Cutout
 Dimension (WxD): 91.5 x 18.5 mm

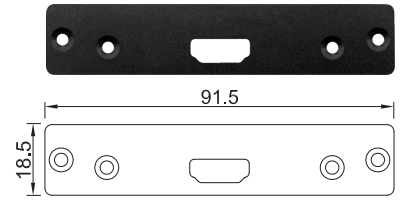

UB1611
Universal Bracket with 2x RJ45 Cutout
 Dimension (WxD): 91.5 x 18.5 mm

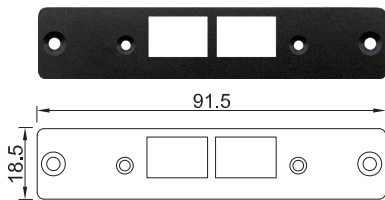

UB1614
Universal Bracket with 2x USB Cutout
 Dimension (WxD): 91.5 x 18.5 mm

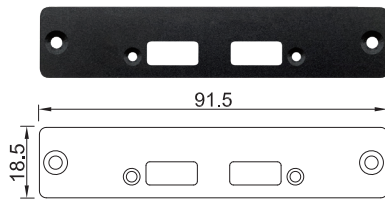

UB1618
Universal Bracket with DIO Cutout
 Dimension (WxD): 91.5 x 18.5 mm

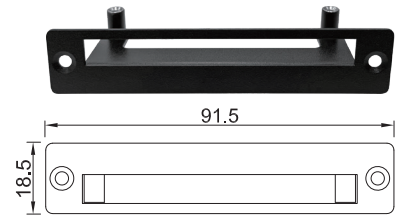

UB1710
Universal Bracket with 4x M12 A-Coded Cutout
 Dimension (WxD): 96.95 x 18.4 mm

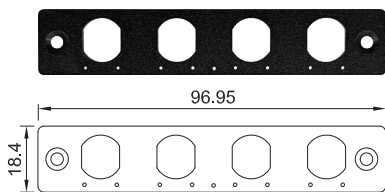

UB1712
Universal Bracket with 4x RJ45 Cutout
 Dimension (WxD): 96.95 x 18.4 mm

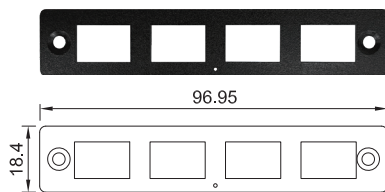

UB1728
Universal Bracket with 2x RJ45 Cutout for CMI-10GLAN Expansion
 Dimension (WxD): 96.95 x 18.4 mm

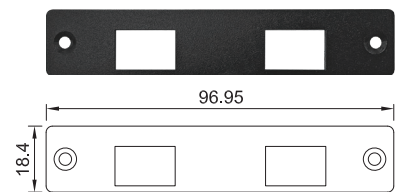

UB1803

Universal Bracket with 2x DB9 Cutout
Dimension (WxD): 98.85 x 41.5 mm

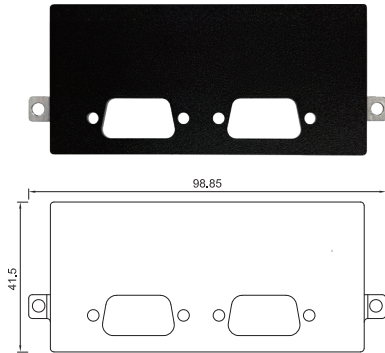

UB1810

Universal Bracket with 4x M12 Cutout
Dimension (WxD): 98.85 x 41.5 mm

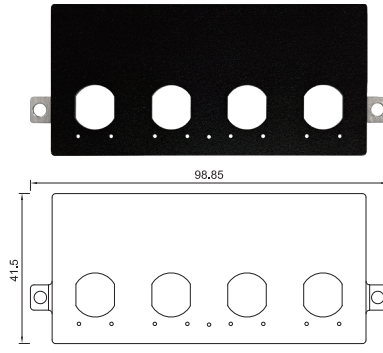

UB1812

Universal Bracket with 4x RJ45 Cutout
Dimension (WxD): 98.85 x 41.5 mm

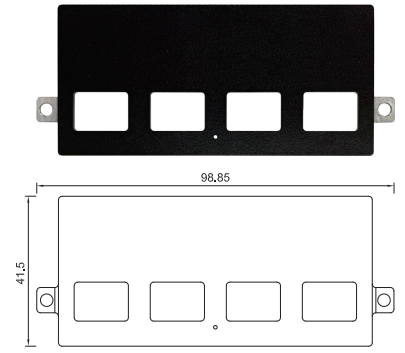

UB1818

Universal Bracket with DIO Cutout
Dimension (WxD): 98.85 x 41.5 mm

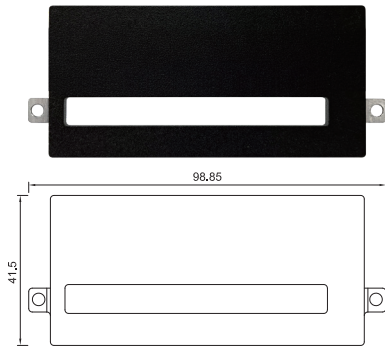

UB1828

Universal Bracket with 2x RJ45 Cutout
Dimension (WxD): 98.85 x 41.5 mm

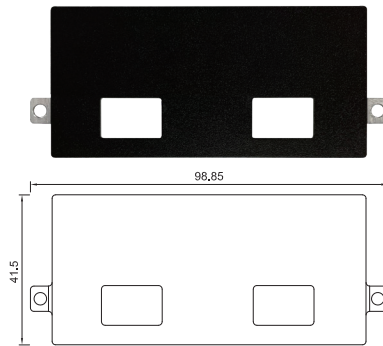

UB1830

Universal Bracket with 4x M12 X-Coded Cutout
Dimension (WxD): 98.85 x 41.5 mm

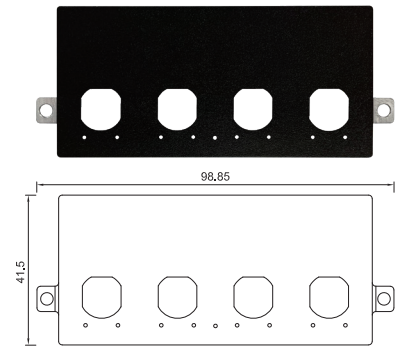

Compatible List

Rugged Embedded Computer

Model No.	DA Series	DC Series	DE Series	DI Series	DV Series	DX Series	DS Series
UB0111		DC-1100					
UB0203			DE-1001 DE-1002				
UB0211			DE-1001 DE-1002				
UB0214			DE-1001 DE-1002				
UB0303							DS-1100 DS-1200 DS-1300 DS-1400
UB0311							DS-1100 DS-1200 DS-1300 DS-1400
UB0314							DS-1100 DS-1200 DS-1300 DS-1400
UB0403	DA-1000 DA-1100 DA-1200						
UB0406	DA-1000 DA-1100 DA-1200						
UB0407	DA-1000 DA-1100 DA-1200						
UB0408	DA-1000 DA-1100 DA-1200						
UB0409	DA-1000 DA-1100 DA-1200						
UB0411	DA-1000 DA-1100 DA-1200						
UB0415	DA-1000 DA-1100 DA-1200						
UB0416	DA-1000 DA-1100 DA-1200						
UB0429	DA-1000 DA-1100 DA-1200						
UB0610							DS-1100
UB0612							DS-1100
UB0630							DS-1100
UB0703				DI-1000			
UB0710				DI-1000			
UB0711				DI-1000			
UB0712				DI-1000			

Model No.	DA Series	DC Series	DE Series	DI Series	DV Series	DX Series	DS Series
UB0903						DX-1000 DX-1100	
UB0910						DX-1000 DX-1100	
UB0911						DX-1000 DX-1100	
UB0912						DX-1000 DX-1100	
UB0918						DX-1000 DX-1100	
UB0930						DX-1000 DX-1100 DX-1200	
UB0932						DX-1000 DX-1100 DX-1200	
UB1004							DS-1200 DS-1300 DS-1400
UB1010							DS-1200 DS-1300 DS-1400
UB1012							DS-1200 DS-1300 DS-1400
UB1018							DS-1200 DS-1300 DS-1400
UB1028							DS-1300 DS-1400
UB1030							DS-1200 DS-1300 DS-1400
UB1103		DC-1200 DC-1300					
UB1106		DC-1300					
UB1107		DC-1200 DC-1300					
UB1108		DC-1200 DC-1300					
UB1111		DC-1200 DC-1300					
UB1115		DC-1200 DC-1300					
UB1116		DC-1200 DC-1300					
UB1129		DC-1200					
UB1131		DC-1200 DC-1300					
UB1134		DC-1300					
UB1303						DX-1200	
UB1311						DX-1200	
UB1318						DX-1200	

Model No.	DA Series	DC Series	DE Series	DI Series	DV Series	DX Series	DS Series
UB1503				DI-1100 DI-1200			
UB1506				DI-1200			
UB1508				DI-1200			
UB1510				DI-1100 DI-1200			
UB1511				DI-1100			
UB1512				DI-1100 DI-1200			
UB1516				DI-1200			
UB1518				DI-1100 DI-1200			
UB1528				DI-1100 DI-1200			
UB1603					DV-1000 DV-1100		
UB1606					DV-1000 DV-1100		
UB1608					DV-1000 DV-1100		
UB1611					DV-1000		
UB1614					DV-1000		
UB1618					DV-1000 DV-1100		
UB1710						DX-1200	
UB1712						DX-1200	
UB1728						DX-1200	

Convertible Embedded System

Model No.	P1001 Series	P2002 Series	P2102 Series	P2202 Series
UB0303	P1001E			
UB0311	P1001E			
UB0314	P1001E			
UB0503		P2002		
UB0504		P2002		
UB0511		P2002		
UB0514		P2002		
UB1203			P2102E	P2202E
UB1211			P2102E	P2202E
UB1214			P2102E	P2202E

Embedded GPU Computer

Model No.	GM Series	GP Series
UB0932	GM-1000 GM-1100	
UB1303	GM-1000 GM-1100	
UB1310	GM-1000 GM-1100	
UB1311	GM-1000	
UB1312	GM-1000 GM-1100	
UB1314	GM-1000	
UB1318	GM-1000 GM-1100	
UB1328	GM-1000 GM-1100	
UB1329	GM-1000 GM-1100	
UB1330	GM-1000 GM-1100	
UB1332	GM-1000 GM-1100	
UB1403		GP-3000
UB1410		GP-3000
UB1412		GP-3000
UB1414		GP-3000
UB1418		GP-3000
UB1428		GP-3000
UB1803		GP-3100
UB1810		GP-3100
UB1812		GP-3100
UB1818		GP-3100
UB1828		GP-3100
UB1830		GP-3100

Ordering Information

Model No.	Description
UB0111	Universal Bracket with 2x RJ45 Cutout for DC-1100
UB0203	2x Universal Bracket each with 1x DB9 Cutout for DE-1000 Series
UB0211	Universal Bracket with 2x RJ45 Cutout for DE-1000 Series
UB0214	Universal Bracket with 2x USB Cutout for DE-1000 Series
UB0303	2x Universal Bracket each with 1x DB9 Cutout
UB0311	Universal Bracket with 2x RJ45 Cutout
UB0314	Universal Bracket with 2x USB Cutout
UB0403	Universal Bracket with 2x DB9 Cutout for CMI-COM, MEC-COM & MEC-CAN Expansion
UB0406	Universal Bracket with 1x DP Cutout for CMI-DP Expansion
UB0407	Universal Bracket with 1x DVI Cutout for CMI-DVI-D Expansion
UB0408	Universal Bracket with 1x HDMI Cutout for CMI-HDMI Expansion
UB0409	Universal Bracket with 1x LPT, 1x PS/2 Cutout for CMI-LPPS Expansion
UB0411	Universal Bracket with 2x RJ45 Cutout for MEC-LAN Expansion
UB0415	Universal Bracket with 1x 10 Pin Terminal Block Cutout for CMI-DIO Expansion
UB0416	Universal Bracket with 1x VGA Cutout for CMI-VGA Expansion
UB0429	Universal Bracket with 2x Antenna Cutout for DA Series
UB0503	Universal Bracket with 2x DB9 Cutout for P2000 Series
UB0504	Universal Bracket with 4x DB9 Cutout for P2000 Series
UB0511	Universal Bracket with 2x RJ45 Cutout for P2000 Series
UB0514	Universal Bracket with 2x USB Cutout for P2000 Series
UB0610	Universal Bracket with 4x M12 Cutout for DS-1100 Series
UB0612	Universal Bracket with 4x RJ45 Cutout for DS-1100 Series
UB0630	Universal Bracket with 4x M12 X-Coded Cutout
UB0703	Universal Bracket with 2x DB9 Cutout for DI-1000
UB0710	Universal Bracket with 4x M12 Cutout for DI-1000
UB0711	Universal Bracket with 2x RJ45 Cutout for DI-1000
UB0712	Universal Bracket with 4x RJ45 Cutout for DI-1000
UB0903	Universal Bracket with 2x DB9 Cutout for DX-1000
UB0910	Universal Bracket with 4x M12 Cutout for DX-1000
UB0911	Universal Bracket with 2x RJ45 Cutout for DX-1000
UB0912	Universal Bracket with 4x RJ45 Cutout for DX-1000
UB0918	Universal Bracket with DIO Cutout for DX-1000
UB0930	Universal Bracket with 4x M12 X-Coded Cutout for DX Series
UB0932-R10	Universal Bracket with 3x Antenna Cutout
UB1004	Universal Bracket with 4x DB9 Cutout
UB1010	Universal Bracket with 4x M12 Cutout
UB1012	Universal Bracket with 4x RJ45 Cutout
UB1018	Universal Bracket with DIO Cutout
UB1028	Universal Bracket with 2x RJ45 Cutout
UB1030	Universal Bracket with 4x M12 X-Coded Cutout
UB1103	Universal Bracket with 2x DB9 Cutout for CMI-COM, MEC-COM & MEC-CAN Expansion
UB1106-R10	Universal Bracket with 1x DP Cutout for CMI-DP Expansion
UB1107	Universal Bracket with 1x DVI Cutout for CMI-DVI Expansion
UB1108	Universal Bracket with 1x HDMI Cutout for CMI-HDMI Expansion
UB1111	Universal Bracket with 2x RJ45 Cutout for MEC-LAN Expansion
UB1115	Universal Bracket with 1x 10 Pin Terminal Block Cutout for CMI-DIO Expansion
UB1116	Universal Bracket with 1x VGA Cutout for CMI-VGA Expansion
UB1129	Universal Bracket with 2x RJ45 Cutout for DC-1200 Rear Bezel
UB1131-R10	Universal Bracket with 2x Antenna Cutout
UB1134-R10	Universal Bracket with 2x USB Type A Cutout for MEC-USB (M.2 interface) Expansion

Model No.	Description
UB1203	Universal Bracket with 2x DB9 Cutout for P2102E
UB1211	Universal Bracket with 2x RJ45 Cutout for P2102E
UB1214	Universal Bracket with 2x USB Cutout for P2102E
UB1303	Universal Bracket with 2x DB9 Cutout for GM Series
UB1310	Universal Bracket with 4x M12 Cutout for GM Series
UB1311	Universal Bracket with 2x RJ45 Cutout for GM-1000
UB1312	Universal Bracket with 4x RJ45 Cutout for GM Series
UB1314	Universal Bracket with 2x USB Cutout for GM-1000
UB1318	Universal Bracket with DIO Cutout for GM Series
UB1328	Universal Bracket with 2x RJ45 Cutout for GM Series
UB1329	Universal Bracket with 4x DP Cutout for GM Series
UB1330	Universal Bracket with 4x M12 X-Coded Cutout
UB1332-R10	Universal Bracket with 3x Antenna Cutout
UB1403	Universal Bracket with 2x DB9 Cutout for GP-3000
UB1410	Universal Bracket with 4x M12 Cutout for GP-3000
UB1412	Universal Bracket with 4x RJ45 Cutout for GP-3000
UB1414	Universal Bracket with 2x USB Cutout for GP-3000
UB1418	Universal Bracket with DIO Cutout for GP-3000
UB1428	Universal Bracket with 2x RJ45 Cutout for GP-3000
UB1503-R11	Universal Bracket with 2x DB9 Cutout
UB1506-R10	Universal Bracket with DisplayPort Cutout
UB1508-R10	Universal Bracket with HDMI Cutout
UB1510-R11	Universal Bracket with 4x M12 Cutout
UB1511-R11	Universal Bracket with 2x RJ45 Cutout
UB1512-R11	Universal Bracket with 4x RJ45 Cutout
UB1516-R10	Universal Bracket with VGA Cutout
UB1518-R10	Universal Bracket with DIO Cutout
UB1528-R11	Universal Bracket with 2x RJ45 Cutout
UB1603-R10	Universal Bracket with 2x DB9 Cutout
UB1606-R10	Universal Bracket with DP Cutout
UB1608-R10	Universal Bracket with HDMI Cutout
UB1611-R10	Universal Bracket with 2x RJ45 Cutout
UB1614-R10	Universal Bracket with 2x USB Cutout
UB1618-R20	Universal Bracket with DIO Cutout
UB1710-R10	Universal Bracket with 4x M12 A-Coded Cutout
UB1712-R10	Universal Bracket with 4x RJ45 Cutout
UB1728-R10	Universal Bracket with 2x RJ45 Cutout for CMI-10GLAN Expansion
UB1803-R10	Universal Bracket with 2x DB9 Cutout
UB1810-R10	Universal Bracket with 4x M12 Cutout
UB1812-R10	Universal Bracket with 4x RJ45 Cutout
UB1818-R10	Universal Bracket with DIO Cutout
UB1828-R10	Universal Bracket with 2x RJ45 Cutout
UB1830-R10	Universal Bracket with 4x M12 X-Coded Cutout