

# DX-1200

14/13/12th Gen. Intel® Core Series High Performance and Compact Rugged Embedded Computer

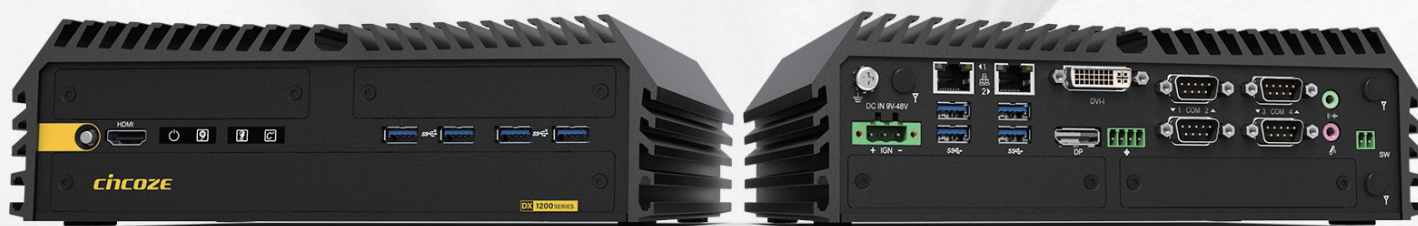

## MAX. PERFORMANCE | MIN. FOOTPRINT

DX-1200, 14 / 13 / 12<sup>th</sup> Gen. Intel Core Processor Rugged Embedded Computer

### Overview

[CONTACT](#)

The DX-1200 is a fanless embedded computer that packs extreme performance into a rugged, compact chassis, making it the ideal choice for smart manufacturing, machine vision, and edge AI applications. 14th/13th/12th gen Intel® Core™ (Raptor Lake-S Refresh/Raptor Lake-S/Alder Lake-S) processor (TDP up to 65W) and DDR5 5600 MHz memory provide high-speed computing performance, while additional functions, including rich native I/O and modular expansion design, meet the requirements for a wide range of applications.

### Key Features

- Intel® 14/13/12th Gen. Raptor Lake-S Refresh / Raptor Lake-S / Alder Lake-S Core™ i9/i7/i5/i3 Processors (max 65 W TDP)
- 2 x DDR5 SO-DIMM Sockets, Supports ECC/non ECC type Memory, Up to 5600MHZ, 64GB
- Quad Independent Display (HDMI / DP / DVI-I)
- 1x M.2 Key E Type 2230 Socket for Intel CNVi / Wireless Module
- CMI Technology for Optional I/O Module Expansions
- CFM Technology for Power Ignition Sensing & PoE Function
- Wide Operating Temperature -40°C to 70°C
- Safety Standard: UL, cUL, CB, IEC, EN 62368-1

### Certifications



### Rapid Processing and Inference

The DX-1200 supports 14/13/12th gen Intel® Core™ i9/i7/i5/i3 (Raptor Lake-S Refresh/Alder Lake-S) processors based on the Intel 7 process, with up to 24 cores (8P + 16E) and 32 threads, delivering more than 2.5x the speed of Comet Lake-S platform. The Intel® Xe architecture of the UHD 770 graphics chip boosts GPU image classification inference performance to 2.8x the speed of Comet Lake-S, providing the processing performance needed for AI and edge computing.

#### CPU Performance



#### GPU Image Classification Inference Performance

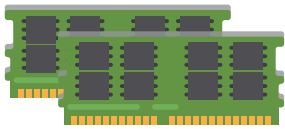

### DDR5 ECC Memory

### High-speed, Safe Memory

Two DDR5 SO-DIMM slots support up to 64GB of 5600MHz memory and include ECC (Error Correction Code) technology, giving the extra stability and reliability needed for industrial automation applications.

### Rich and Diverse Expandability

To cater to the widest range of industrial applications, the DX-1200 provides one M.2 Key E slot and two Mini PCIe slots for the addition of WiFi, GNSS, 4G, and Bluetooth. The Mini PCIe slots also support I/O expansion cards, frame grabber cards, and more, to meet different application requirements.

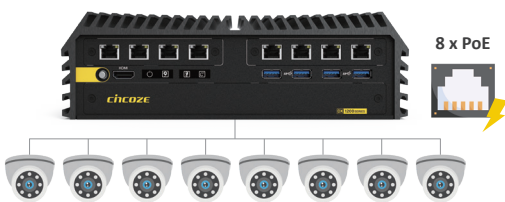

### High-speed, Reliable Data Transmission

To improve the transfer rate of videos or large files, the DX-1200 supports up to four high-speed 10Gbps LAN ports. And for application environments that require multiple network connections, the DX-1200 supports up to 8x PoE, providing data and power through the same cable to reduce the difficulty of wiring.

### Robust and Reliable

The DX-1200 is built tough, reflected in its industrial-grade protection design and industry certifications in different fields. In addition to features such as wide temperature (-40 - 70°C), wide voltage input (9 - 48 VDC), overvoltage, overcurrent, and ESD protection, it also complies with the US military shock vibration standard MIL-STD-810G. Product safety and reliability are further ensured with internationally recognized UL 62368-1 safety certification. For more secure railway computing, it also passes the EMC EN 50121-3-2 standard in EN 50155 and the EN 45545-2 fire protection standard.



## Specifications

Model Name	DX-1200
<b>System</b>	
Processor	<ul style="list-style-type: none"> <li>• 14th Generation Intel® Raptor Lake-S Refresh Series CPU:                             <ul style="list-style-type: none"> <li>- Intel® Core™ i9-14900 24 Cores Up to 5.8 GHz, TDP 65W</li> <li>- Intel® Core™ i7-14700 20 Cores Up to 5.4 GHz, TDP 65W</li> <li>- Intel® Core™ i5-14500 14 Cores Up to 5.0 GHz, TDP 65W</li> <li>- Intel® Core™ i5-14400 10 Cores Up to 4.7 GHz, TDP 65W</li> <li>- Intel® Core™ i3-14100 4 Cores Up to 4.7 GHz, TDP 60W</li> <li>- Intel® Core™ i9-14901E 8 Cores Up to 5.6 GHz, TDP 65W</li> <li>- Intel® Core™ i7-14701E 8 Cores Up to 5.4 GHz, TDP 65W</li> <li>- Intel® Core™ i5-14501E 6 Cores Up to 5.2 GHz, TDP 65W</li> <li>- Intel® Core™ i5-14401E 6 Cores Up to 4.7 GHz, TDP 65W</li> <li>- Intel® Core™ i9-14900T 24 Cores Up to 5.5 GHz, TDP 35W</li> <li>- Intel® Core™ i7-14700T 20 Cores Up to 5.2 GHz, TDP 35W</li> <li>- Intel® Core™ i5-14500T 14 Cores Up to 4.8 GHz, TDP 35W</li> <li>- Intel® Core™ i5-14400T 10 Cores Up to 4.5 GHz, TDP 35W</li> <li>- Intel® Core™ i3-14100T 4 Cores Up to 4.4 GHz, TDP 35W</li> <li>- Intel® Core™ i9-14901TE 8 Cores Up to 5.5 GHz, TDP 45W</li> <li>- Intel® Core™ i7-14701TE 8 Cores Up to 5.2 GHz, TDP 45W</li> <li>- Intel® Core™ i5-14501TE 6 Cores Up to 5.1 GHz, TDP 45W</li> <li>- Intel® Core™ i5-14401TE 6 Cores Up to 4.5 GHz, TDP 45W</li> <li>- Intel® Processor 300 2 Cores Up to 3.9 GHz, TDP 46W</li> <li>- Intel® Processor 300T 2 Cores Up to 3.4 GHz, TDP 35W</li> </ul> </li> <li>• 13th Generation Intel® Raptor Lake-S Series CPU:                             <ul style="list-style-type: none"> <li>- Intel® Core™ i9-13900E 24 Cores Up to 5.2 GHz, TDP 65W</li> <li>- Intel® Core™ i7-13700E 16 Cores Up to 5.1 GHz, TDP 65W</li> <li>- Intel® Core™ i5-13500E 14 Cores Up to 4.6 GHz, TDP 65W</li> <li>- Intel® Core™ i5-13400E 10 Cores Up to 4.6 GHz, TDP 65W</li> <li>- Intel® Core™ i3-13100E 4 Cores Up to 4.4 GHz, TDP 60W</li> <li>- Intel® Core™ i9-13900TE 24 Cores Up to 5.0 GHz, TDP 35W</li> <li>- Intel® Core™ i7-13700TE 16 Cores Up to 4.8 GHz, TDP 35W</li> <li>- Intel® Core™ i5-13500TE 14 Cores Up to 4.5 GHz, TDP 35W</li> <li>- Intel® Core™ i3-13100TE 4 Cores Up to 4.1 GHz, TDP 35W</li> </ul> </li> <li>• 12th Generation Intel® Alder Lake-S Series CPU:                             <ul style="list-style-type: none"> <li>- Intel® Core™ i9-12900E 16 Cores Up to 5 GHz, TDP 65W</li> <li>- Intel® Core™ i7-12700E 12 Cores Up to 4.8 GHz, TDP 65W</li> <li>- Intel® Core™ i5-12500E 6 Cores Up to 4.5 GHz, TDP 65W</li> <li>- Intel® Core™ i3-12100E 4 Cores Up to 4.2 GHz, TDP 60W</li> <li>- Intel® Core™ i9-12900TE 16 Cores Up to 4.8 GHz, TDP 35W</li> <li>- Intel® Core™ i7-12700TE 12 Cores Up to 4.7 GHz, TDP 35W</li> <li>- Intel® Core™ i5-12500TE 6 Cores Up to 4.3 GHz, TDP 35W</li> <li>- Intel® Core™ i3-12100TE 4 Cores Up to 4.0 GHz, TDP 35W</li> <li>- Intel® Pentium® G7400E 2 Cores Up to 3.6 GHz, TDP 46W</li> <li>- Intel® Pentium® G7400TE 2 Cores Up to 3.0 GHz, TDP 35W</li> <li>- Intel® Celeron® G6900E 2 Cores Up to 3.0 GHz, TDP 46W</li> <li>- Intel® Celeron® G6900TE 2 Cores Up to 2.4 GHz, TDP 35W</li> </ul> </li> </ul>
Chipset	<ul style="list-style-type: none"> <li>• Intel R680E Chipset</li> </ul>
Memory	<ul style="list-style-type: none"> <li>• 2x DDR5 SO-DIMM sockets, support Un-buffered and ECC Type memory, up to 64GB.</li> <li>- Core™ i9/i7: Support 5600/4800 MHz with Single Rank memory and 5200/4800 MHz with Dual Rank memory.</li> <li>- Core™ i5/i3/Pentium®/Celeron®/Intel® Processor: Support 4800 MHz.</li> </ul>
BIOS	<ul style="list-style-type: none"> <li>• AMI BIOS</li> </ul>
<b>Graphics</b>	
Graphics Engine	<ul style="list-style-type: none"> <li>• Integrated Intel® UHD Graphics 770: Core™ i9/i7/i5</li> <li>• Integrated Intel® UHD Graphics 730: Core™ i3</li> <li>• Integrated Intel® UHD Graphics 710: Pentium®/Celeron®</li> </ul>
Maximum Display Output	<ul style="list-style-type: none"> <li>• Supports Quad Independent Display</li> </ul>
DVI	<ul style="list-style-type: none"> <li>• 1x DVI-I Connector</li> <li>- VGA: 1920 x 1080 @ 60 Hz</li> <li>- DVI-D: 1920 x 1200 @ 60 Hz</li> </ul>
DP	<ul style="list-style-type: none"> <li>• 1x DP Connector: 4096 x 2304 @ 60Hz</li> <li>* Verified maximum resolution: 3840 x 2160 @ 60Hz</li> </ul>

HDMI	<ul style="list-style-type: none"> <li>• 1x HDMI Connector: 3840 x 2160 @ 30Hz</li> </ul>
<b>Audio</b>	
Audio Codec	<ul style="list-style-type: none"> <li>• Realtek® ALC888, High Definition Audio</li> </ul>
Line-out	<ul style="list-style-type: none"> <li>• 1x Line-out, Phone Jack 3.5mm</li> </ul>
Mic-in	<ul style="list-style-type: none"> <li>• 1x Mic-in, Phone Jack 3.5mm</li> </ul>
<b>I/O</b>	
LAN	<ul style="list-style-type: none"> <li>• 2x 1GbE LAN, RJ45(Supports Wake on LAN, PXE)                             <ul style="list-style-type: none"> <li>- GbE1: Intel® I219</li> <li>- GbE2: Intel® I210</li> </ul> </li> </ul>
COM	<ul style="list-style-type: none"> <li>• 4x RS-232/422/485 with Auto Flow Control (Supports 5V/12V), DB9</li> </ul>
USB	<ul style="list-style-type: none"> <li>• 4 x USB 3.2 Gen2x1 (10Gbps), Type A</li> <li>• 4 x USB 3.2 Gen1x1 (5Gbps), Type A</li> </ul>
<b>Storage</b>	
SSD/HDD	<ul style="list-style-type: none"> <li>• 2x 2.5" SATA HDD/SSD Bay Supporting Hot Swap Function (SATA 3.0)</li> </ul>
mSATA	<ul style="list-style-type: none"> <li>• 2x mSATA Socket (SATA 3.0, shared by Mini-PCIe socket )</li> </ul>
RAID	<ul style="list-style-type: none"> <li>• Support RAID 0/1/5/10</li> </ul>
<b>Expansion</b>	
Mini PCI Express	<ul style="list-style-type: none"> <li>• 2x Full-size Mini-PCIe Socket</li> </ul>
M.2 E Key Socket	<ul style="list-style-type: none"> <li>• 1x M.2 Key E Type 2230 Socket, Support Intel CNVi Module</li> </ul>
SIM Socket	<ul style="list-style-type: none"> <li>• 1x SIM Socket</li> </ul>
CMI (Combined Multiple I/O) Interface	<ul style="list-style-type: none"> <li>• 2x High Speed CMI Interface for optional CMI Module Expansion</li> <li>• 1x Low Speed CMI Interface for optional CMI Module Expansion</li> </ul>
CFM (Control Function Module) Interface	<ul style="list-style-type: none"> <li>• 1x CFM IGN Interface for optional CFM-IGN Module Expansion</li> </ul>
<b>Other Function</b>	
External FAN Connector	<ul style="list-style-type: none"> <li>• 1x External FAN Connector, 4-pin Terminal Block (Support Smart Fan by BIOS)</li> </ul>
Clear CMOS Switch	<ul style="list-style-type: none"> <li>• 1x Clear CMOS Switch</li> </ul>
Reset Button	<ul style="list-style-type: none"> <li>• 1x Reset Button</li> </ul>
Instant Reboot	<ul style="list-style-type: none"> <li>• Support 0.2sec Instant Reboot Technology</li> </ul>
Watchdog Timer	<ul style="list-style-type: none"> <li>• Software Programmable Supports 256 Levels System Reset</li> </ul>
<b>Power</b>	
Power Button	<ul style="list-style-type: none"> <li>• 1x ATX Power On/Off Button</li> </ul>
Power Mode Switch	<ul style="list-style-type: none"> <li>• 1x AT/ATX Mode Switch</li> </ul>
Power Input	<ul style="list-style-type: none"> <li>• 9-48VDC, 3-pin Terminal Block</li> </ul>
Remote Power On/Off	<ul style="list-style-type: none"> <li>• 1x Remote Power On/Off, 2-pin Terminal Block</li> </ul>
Max. Power Consumption	<ul style="list-style-type: none"> <li>• 35WCPU: 201.17W</li> <li>• 65WCPU: 274.80W                             <ul style="list-style-type: none"> <li>- Test conducted with CPU, 1x RAM, and 1x storage</li> <li>- 100% load during burn-in testing</li> </ul> </li> </ul>
Inrush Current (Peak)	<ul style="list-style-type: none"> <li>• 35W CPU: 4.151 A@24V</li> <li>• 65W CPU: 4.360 A@24V</li> </ul>

<b>Physical</b>	
Dimension ( W x D x H )	• 242 x 173 x 75 mm
Weight Information	• 3.05 kg
Mechanical Construction	• Extruded Aluminum with Heavy Duty Metal
Mounting	• Wall / DIN-RAIL / VESA / Side Mount
Physical Design	<ul style="list-style-type: none"> <li>• Fanless Design</li> <li>• Cableless Design</li> <li>• Jumper-less Design</li> <li>• Unibody Design</li> </ul>
<b>Reliability &amp; Protection</b>	
Reverse Power Input Protection	• Yes
Over Voltage Protection	<ul style="list-style-type: none"> <li>• Protection Range: 51~58V</li> <li>• Protection Type: shut down operating voltage, re-power on at the preset level to recover</li> </ul>
Over Current Protection	• 15A
CMOS Battery Backup	• SuperCap Integrated for CMOS Battery Maintenance-free Operation
MTBF	• 394,488 Hours - Database: Telcordia SR-332 Issue3, Method 1, Case 3
<b>Operating System</b>	
Windows	• Windows®11, Windows® 10
Linux	• Ubuntu Desktop 22.04 LTS
<b>Environment</b>	
Operating Temperature	<ul style="list-style-type: none"> <li>• 35W TDP Processor: -40°C to 70°C</li> <li>• 65W TDP Processor: -40°C to 50°C (With External Fan Kit)</li> <li>- With extended temperature peripherals; Ambient with air flow</li> <li>- According to IEC60068-2-1, IEC60068-2-2, IEC60068-2-14</li> </ul>
Storage Temperature	• -40°C to 85°C
Relative Humidity	• 95% RH @ 70°C (Non-condensing)
Shock	• MIL-STD-810G
Vibration	• MIL-STD-810G
EMC	<ul style="list-style-type: none"> <li>• CE, UKCA, FCC, ICES-003 Class A</li> <li>• EN 50155 (EN 50121-3-2 Only)</li> <li>• E-Mark</li> </ul>
EMI	<ul style="list-style-type: none"> <li>• CISPR 32 Conducted &amp; Radiated: Class A</li> <li>• EN/BS EN 50121-3-2 Conducted &amp; Radiated: Class A</li> <li>• EN/BS EN IEC 61000-3-2 Harmonic current emissions: Class A</li> <li>• EN/BS EN61000-3-3 Voltage fluctuations &amp; flicker</li> <li>• FCC 47 CFR Part 15B, ICES-003 Conducted &amp; Radiated: Class A</li> </ul>
EMS	<ul style="list-style-type: none"> <li>• EN/IEC 61000-4-2 ESD: Contact: 6 kV; Air: 8 kV</li> <li>• EN/IEC 61000-4-3 RS: 80 MHz to 1000 MHz: 20 V/m</li> <li>• EN/IEC 61000-4-4 EFT: AC Power: 2 kV; Signal: 2 kV</li> <li>• EN/IEC 61000-4-5 Surges: AC Power: 2 kV</li> <li>• EN/IEC 61000-4-6 CS: 10V</li> <li>• EN/IEC 61000-4-8 PFMF: 50 Hz, 1A/m</li> <li>• EN/IEC 61000-4-11 Voltage Dips &amp; Voltage Interruptions: 0.5 cycles at 50 Hz</li> </ul>
Safety	• UL, cUL, CB, IEC, EN 62368-1
Fire Protection	• EN 45545-2

**External Layout**

**Front I/O**

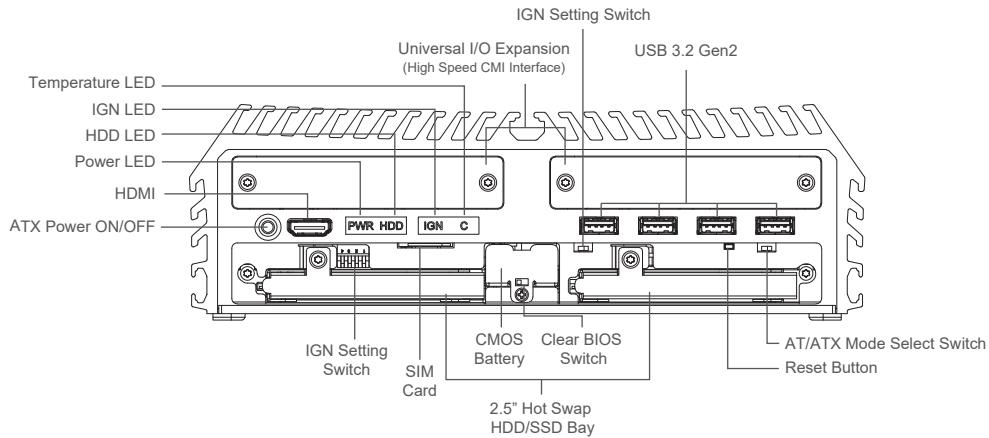

**Rear I/O**

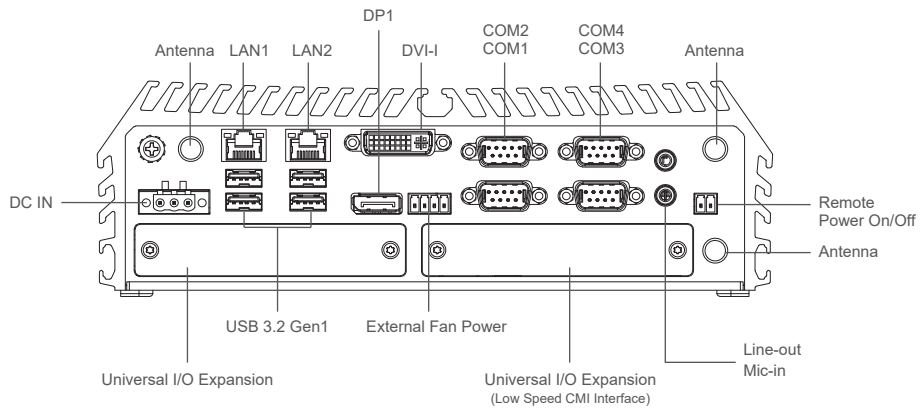

**Dimensions**

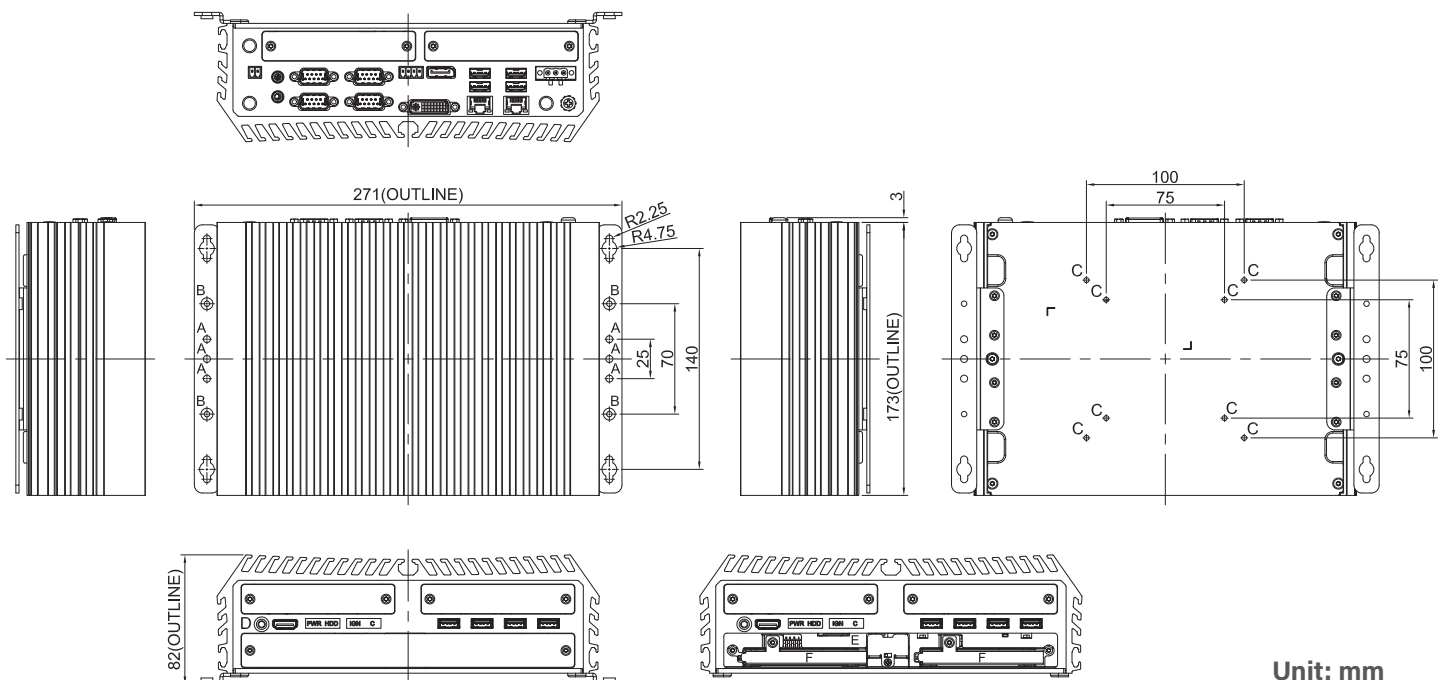

## Ordering Information

### Available Models

Model No.	Description
DX-1200-R10	14/13/12th Gen. Intel® Core Series High Performance and Compact Rugged Embedded Computer

### Package Checklist

• DX-1200 Rugged Computer x1	• Power Terminal Block Connector x1
• CPU Heatsink Pack x1	• Remote Power On/Off Terminal Block Connector x 1
• Screw Pack x 1	• Fan Terminal Block Connector x 1
• Wall Mounting Kit x1	• DVI-I to VGA Adaptor x 1

### Optional Modules and Accessories







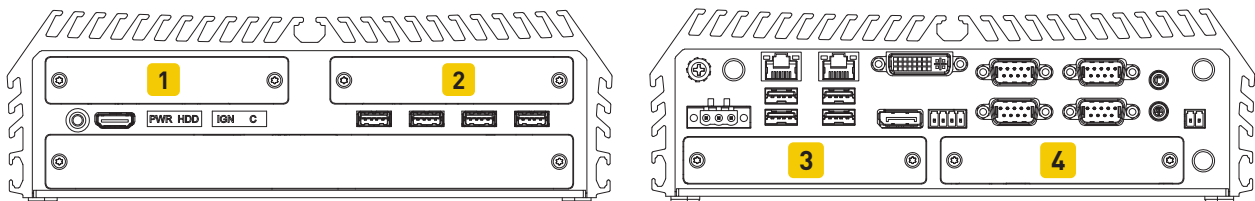

Model No.	Description
CFM-PoE01	CFM Module with PoE Control Function, Individual Port 25.5W
CFM-IGN01	CFM Module with Power Ignition Sensing Control Function, 12V/24V Selectable
CMI-LAN01-R12	CMI Module with 4x RJ45 Intel I210 1GbE LAN Ports
CMI-10GLAN05-R10	CMI Module with 2x Intel 10GbE LAN, RJ45 Port
CMI-M12LAN01-R12	CMI Module with 4 x M12 Intel I210 1GbE LAN Ports
CMI-XM12LAN01-R10	CMI Module with M12 X-Coded Connector, 4x Intel I210 1GbE LAN Ports
CMI-DIO01	CMI Module with 16DIO (8in 8out)
CMI-COM01	CMI Module with 2x RS232/422/485 (Support 5V/12V)
MEC-COM-M212-TDB9	Mini-PCIe Module with 2x RS-232 Serial Ports, 1x Thin DB9 Cable
MEC-COM-M334-TDB9	Mini-PCIe Module with 4x RS-232/422/485 Serial Ports, 2x Thin DB9 Cable
MEC-LAN-M102-30	Mini-PCIe Module with 2x LAN Ports, 2x 30cm cable
UB0930-R10	Universal Bracket with 4x M12 X-Coded Cutout
UB0932-R10	Universal Bracket with 3x Antenna Cutout
UB1303	Universal Bracket with 2x DB9 Cutout
UB1311	Universal Bracket with 2x RJ45 Cutout for MEC-LAN Expansion
UB1318	Universal Bracket with DIO Cutout
UB1710-R10	Universal Bracket with 4x M12 A-Coded Cutout
UB1712-R10	Universal Bracket with 4x RJ45 Cutout
UB1728-R10	Universal Bracket with 2x RJ45 Cutout for CMI-10GLAN Expansion
SIDE-DX	DX Series side mount kit
DIN01	DIN-RAIL Mount Kit, KMRH-K175
GST120A24-CIN	Adapter AC/DC 24V 5A 120W with 3pin Terminal Block Plug and Tubes, Level VI



GST220A24-CIN	Adapter AC/DC 24V 9.2A 220W with 3pin Terminal Block Plug and Tubes, Level VI
GST360A24-CIN	Adapter AC/DC 24V 15A 360W with 3pin Terminal Block Plug and TUBES, Level VI
RSD-200D-24	Railway Single Output DC-DC Converter 200W / DC 24V
FAN-EX101	External Fan with 4pin Terminal Block Plug and Mounting Bracket, Support smart fan

**Optional Module Configuration**

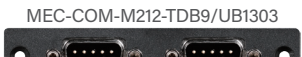

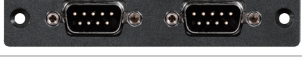
Model No.	Description	1	2	3	4
 CMI-LAN01-R12/UB1712-R10	CMI Module with 4x Intel I210 1GbE LAN, RJ45 Port / Universal Bracket with 4x RJ45 Cutout	V	V	-	-
 CMI-10GLAN05-R10/UB1728-R10	CMI Module with 2x Intel 10GbE LAN, RJ45 Port/ Universal Bracket with 2x RJ45 Cutout	V	V	-	-
 CMI-M12LAN01-R12/UB1710-R10	CMI Module with M12 Connector, 4x Intel 1GbE LAN / Universal Bracket with 4x M12 A-Coded Cutout	V	V	-	-
 CMI-XM12LAN01-R10/UB0930-R10	CMI Module with M12 X-Coded Connector, 4x Intel I210 1GbE LAN Ports / Universal Bracket with 4x M12 X-Coded Cutout	V	V	-	-
 CMI-DIO01/UB1318	CMI Module with 16DIO (8in 8out) / Universal Bracket with DIO Cutout	-	-	-	V
 CMI-COM01/UB1303	CMI Module with 2x RS232/422/485 (Support 5V/12V) / Universal Bracket with 2x DB9 Cutout	-	-	-	V
 MEC-COM-M212-TDB9/UB1303	Mini-PCIe Module with 2x RS-232 Serial Ports, 1x Thin DB9 Cable / Universal Bracket with 2x DB9 Cutout	-	-	V	V
 MEC-COM-M334-TDB9/2xUB1303	Mini-PCIe Module with 4x RS-232/422/485 Serial Ports, 2x Thin DB9 Cable / 2x Universal Bracket with 2x DB9 Cutout	-	-	V	V
 MEC-LAN-M102-30/UB1311	Mini-PCIe Module with 2x LAN Ports, 2x 30cm cable / Universal Bracket with 2x RJ45 Cutout for MEC-LAN Expansion	-	-	V	-

V : Compatible