

***cincoze***

# MXM-A1000 Module

## Quick Installation Guide

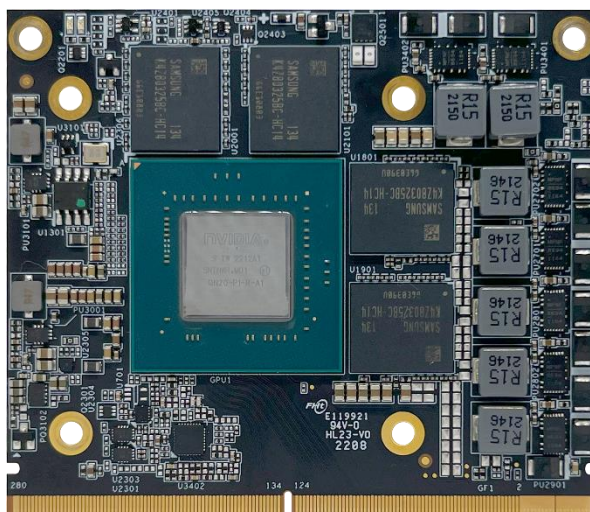

### Embedded MXM GPU Module

NVIDIA Embedded RTX A1000 MXM Type A, 4G, 60W Kit with Heatsink and Thermal Pad

# Contents

|  |    |
|--|----|
| Preface.....                           | 3  |
| Revision .....                         | 3  |
| Copyright Notice .....                 | 3  |
| Acknowledgement .....                  | 3  |
| Disclaimer.....                        | 3  |
| Declaration of Conformity.....         | 3  |
| FCC.....                               | 3  |
| CE.....                                | 4  |
| Product Warranty Statement .....       | 4  |
| Warranty .....                         | 4  |
| RMA.....                               | 4  |
| Limitation of Liability.....           | 5  |
| Technical Support and Assistance ..... | 5  |
| Conventions Used in this Manual .....  | 6  |
| Safety Precautions.....                | 6  |
| Package Contents .....                 | 7  |
| Ordering Information .....             | 7  |
| Chapter 1 Product Introductions .....  | 8  |
| 1.1 Product Pictures .....             | 9  |
| 1.2 Key Features .....                 | 10 |
| 1.3 Specifications .....               | 10 |
| 1.4 Mechanical Dimension.....          | 11 |
| Chapter 2 Module Setup .....           | 12 |
| 2.1 Installing an MXM Module.....      | 13 |

# Preface

## Revision

| Revision | Description   | Date       |
|----------|---------------|------------|
| 1.00     | First Release | 2023/09/27 |
|          |               |            |
|          |               |            |
|          |               |            |

## Copyright Notice

© 2023 by Cincoze Co., Ltd. All rights are reserved. No parts of this manual may be copied, modified, or reproduced in any form or by any means for commercial use without the prior written permission of Cincoze Co., Ltd. All information and specification provided in this manual are for reference only and remain subject to change without prior notice.

## Acknowledgement

Cincoze is a registered trademark of Cincoze Co., Ltd. All registered trademarks and product names mentioned herein are used for identification purposes only and may be trademarks and/or registered trademarks of their respective owners.

## Disclaimer

This manual is intended to be used as a practical and informative guide only and is subject to change without notice. It does not represent a commitment on the part of Cincoze. This product might include unintentional technical or typographical errors. Changes are periodically made to the information herein to correct such errors, and these changes are incorporated into new editions of the publication.

## Declaration of Conformity



### FCC

This equipment has been tested and found to comply with the limits for a Class A digital device, pursuant to Part 15 of the FCC Rules. These limits are designed to provide reasonable protection against harmful interference when the equipment is operated in a commercial environment. This equipment generates, uses, and can radiate radio frequency energy and, if not installed and used in accordance with the instruction manual, may cause harmful interference to radio communications. Operation of this equipment in a residential area is likely to cause harmful interference in which case the user will be required to correct the interference at his own expense.



## CE

The product(s) described in this manual complies with all application European Union (CE) directives if it has a CE marking. For computer systems to remain CE compliant, only CE-compliant parts may be used. Maintaining CE compliance also requires proper cable and cabling techniques.

## Product Warranty Statement

### Warranty

Cincoze products are warranted by Cincoze Co., Ltd. to be free from defect in materials and workmanship for 2 years from the date of purchase by the original purchaser. During the warranty period, we shall, at our option, either repair or replace any product that proves to be defective under normal operation. Defects, malfunctions, or failures of the warranted product caused by damage resulting from natural disasters (such as by lightning, flood, earthquake, etc.), environmental and atmospheric disturbances, other external forces such as power line disturbances, plugging the board in under power, or incorrect cabling, and damage caused by misuse, abuse, and unauthorized alteration or repair, and the product in question is either software, or an expendable item (such as a fuse, battery, etc.), are not warranted.

### RMA

Before sending your product in, you will need to fill in Cincoze RMA Request Form and obtain a RMA number from us. Our staff is available at any time to provide you with the most friendly and immediate service.

#### ■ RMA Instruction

- Customers must fill in Cincoze Return Merchandise Authorization (RMA) Request Form and obtain an RMA number prior to returning a defective product to Cincoze for service.
- Customers must collect all the information about the problems encountered and note anything abnormal and describe the problems on the “Cincoze Service Form” for the RMA number apply process.
- Charges may be incurred for certain repairs. Cincoze will charge for repairs to products whose warranty period has expired. Cincoze will also charge for repairs to products if the damage resulted from acts of God, environmental or atmospheric disturbances, or other external forces through misuse, abuse, or unauthorized alteration or repair. If charges will be incurred for a repair, Cincoze lists all charges, and will wait for customer’s approval before performing the repair.
- Customers agree to ensure the product or assume the risk of loss or damage during transit, to prepay shipping charges, and to use the original shipping container or equivalent.
- Customers can be sent back the faulty products with or without accessories

(manuals, cable, etc.) and any components from the system. If the components were suspected as part of the problems, please note clearly which components are included. Otherwise, Cincoze is not responsible for the devices/parts.

- Repaired items will be shipped along with a "Repair Report" detailing the findings and actions taken.

### **Limitation of Liability**

Cincoze' liability arising out of the manufacture, sale, or supplying of the product and its use, whether based on warranty, contract, negligence, product liability, or otherwise, shall not exceed the original selling price of the product. The remedies provided herein are the customer's sole and exclusive remedies. In no event shall Cincoze be liable for direct, indirect, special or consequential damages whether based on contract of any other legal theory.

### **Technical Support and Assistance**

1. Visit the Cincoze website at [www.cincoze.com](http://www.cincoze.com) where you can find the latest information about the product.
2. Contact your distributor or our technical support team or sales representative for technical support if you need additional assistance. Please have following information ready before you call:
  - Product name and serial number
  - Description of your peripheral attachments
  - Description of your software (operating system, version, application software, etc.)
  - A complete description of the problem
  - The exact wording of any error messages

## Conventions Used in this Manual



**WARNING**  
(AVERTIR)

This indication alerts operators to an operation that, if not strictly observed, may result in severe injury.

(Cette indication avertit les opérateurs d'une opération qui, si elle n'est pas strictement observée, peut entraîner des blessures graves.)



**CAUTION**  
(ATTENTION)

This indication alerts operators to an operation that, if not strictly observed, may result in safety hazards to personnel or damage to equipment.

(Cette indication avertit les opérateurs d'une opération qui, si elle n'est pas strictement observée, peut entraîner des risques pour la sécurité du personnel ou des dommages à l'équipement.)



**NOTE**  
(NOTE)

This indication provides additional information to complete a task easily.

(Cette indication fournit des informations supplémentaires pour effectuer facilement une tâche.)

## Safety Precautions

Before installing and using this device, please note the following precautions.

1. Read these safety instructions carefully.
2. Keep this Quick Installation Guide for future reference.
3. Disconnect this equipment from any AC outlet before cleaning.
4. For plug-in equipment, the power outlet socket must be located near the equipment and must be easily accessible.
5. Keep this equipment away from humidity.
6. Put this equipment on a reliable surface during installation. Dropping it or letting it fall may cause damage.
7. Make sure the voltage of the power source is correct before connecting the equipment to the power outlet.
8. Use a power cord that has been approved for using with the product and that it matches the voltage and current marked on the product's electrical range label. The voltage and current rating of the cord must be greater than the voltage and current rating marked on the product.
9. Position the power cord so that people cannot step on it. Do not place anything over the power cord.
10. All cautions and warnings on the equipment should be noted.
11. If the equipment is not used for a long time, disconnect it from the power source to avoid damage by transient overvoltage.
12. Never pour any liquid into an opening. This may cause fire or electrical shock.
13. Never open the equipment. For safety reasons, the equipment should be opened only by

qualified service personnel.

If one of the following situations arises, get the equipment checked by service personnel:

- The power cord or plug is damaged.
- Liquid has penetrated into the equipment.
- The equipment has been exposed to moisture.
- The equipment does not work well, or you cannot get it work according to the Quick Installation Guide.
- The equipment has been dropped and damaged.
- The equipment has obvious signs of breakage.

14. CAUTION: Risk of Explosion if Battery is replaced by an Incorrect Type. Dispose of Used Batteries According to the Instructions.

ATTENTION: Risque d'explosion si la batterie est remplacée par un type incorrect. Mettre au rebus les batteries usagées selon les instructions.

15. Equipment intended only for use in a RESTRICTED ACCESS AREA.

## Package Contents

Before installation, please ensure all the items listed in the following table are included in the package.

| Item | Description                         | Q'ty |
|------|-------------------------------------|------|
| 1    | NVIDIA RTX™ Embedded A1000 GPU Card | 1    |
| 2    | GPU Heatsink                        | 1    |
| 3    | GPU Thermal Pad Kit                 | 1    |
| 4    | Screw Pack                          | 1    |

*Note: Notify your sales representative if any of the above items are missing or damaged.*

## Ordering Information

| Model No.     | Product Description   |
|---------------|---|
| MXM-A1000-R10 | NVIDIA Embedded RTX A1000 MXM Type A, 4G, 60W Kit with Heatsink and Thermal Pad |



# **Chapter 1**

## **Product Introductions**



## 1.1 Product Pictures

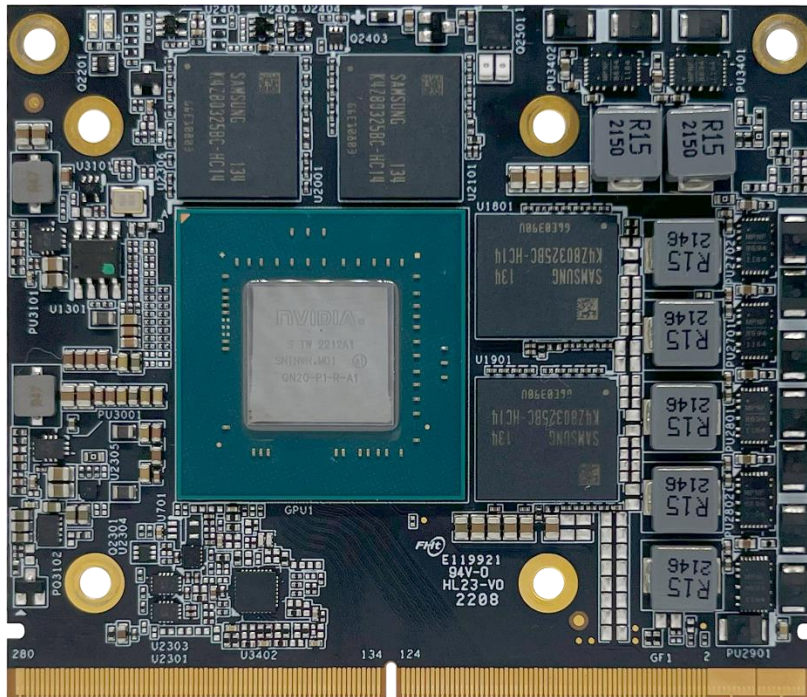

Front

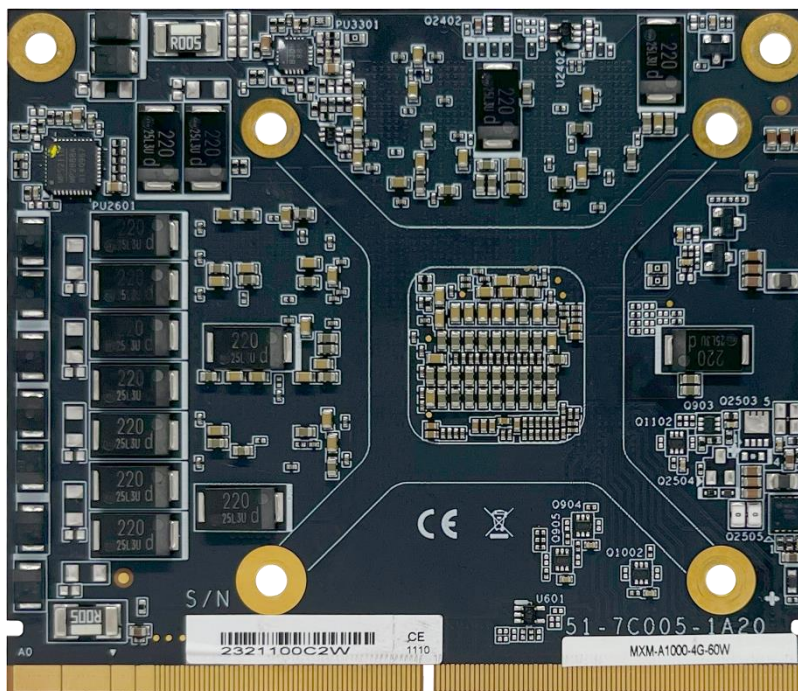

Rear

## 1.2 Key Features

- NVIDIA® RTX™ A1000 Embedded Graphics
- Standard MXM 3.1 Type A Form Factor (82 x 70 mm)
- 2048 NVIDIA® CUDA® Cores, 16 RT cores, and 64 Tensor cores
- 6.66 TFLOPS Peak FP32 Performance
- PCIe Gen 4 x8 interface
- 5-year Availability



## 1.3 Specifications

|                   |   |
|-------------------|---|
| GPU               | NVIDIA RTX™ A1000 GA107-950 GPU                                     |
| Memory            | 4GB GDDR6 memory, 128-bit (Bandwidth: 192 GB/s)                     |
| CUDA Cores        | 2048 CUDA cores, 6.66 TFLOPS peak FP32 performance                  |
| Tensor Cores      | 64 Tensor Cores   |
| RT Cores          | 16 RT Cores   |
| Compute API       | CUDA Compute 8.0 and above, OpenCL™ 1.2                             |
| Graphics API      | DirectX® 12, OpenGL 4.6   |
| Display Outputs   | 4x DisplayPort 1.4 digital video outputs, 4K at 120Hz or 8K at 60Hz |
| Interface         | MXM 3.1, PCI Express Gen4 x8 support                                |
| Dimensions        | 82 (W) x 70 (D) x 4.8 (H) mm  |
| Form Factor       | Standard MXM 3.1 Type A   |
| Power Consumption | 60W   |
| OS Support        | Windows 10 & Linux support by project                               |

# 1.4 Mechanical Dimension

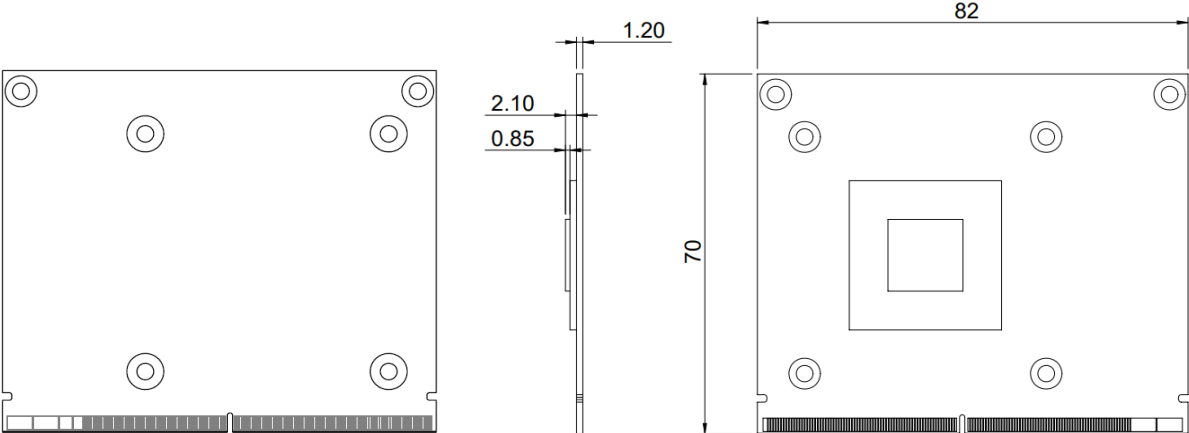
Unit: mm





# **Chapter 2**

## **Module Setup**

## 2.1 Installing an MXM Module

This chapter is to demonstrate how to setup an MXM Module onto an MXM Module supported system. Before this chapter gets started, users need to follow the instructions of the system's user manual to remove the system's chassis cover and to install the MXM carrier board.

1. Locate the slot on the MXM carrier board installed on the MXM Module supported system. The system used here is GM-1000.

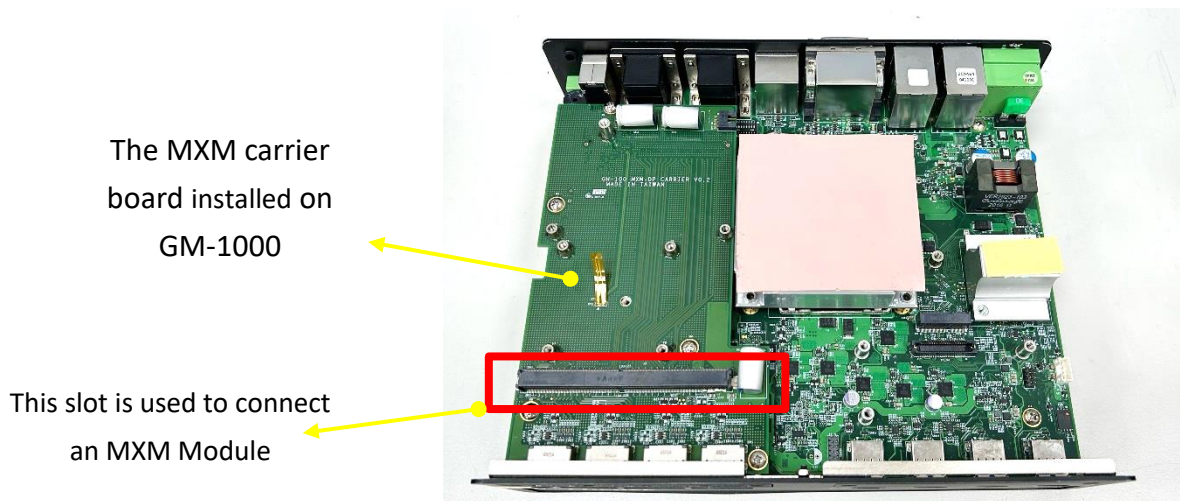

2. Place the thermal pads on the chips of the MXM Module.

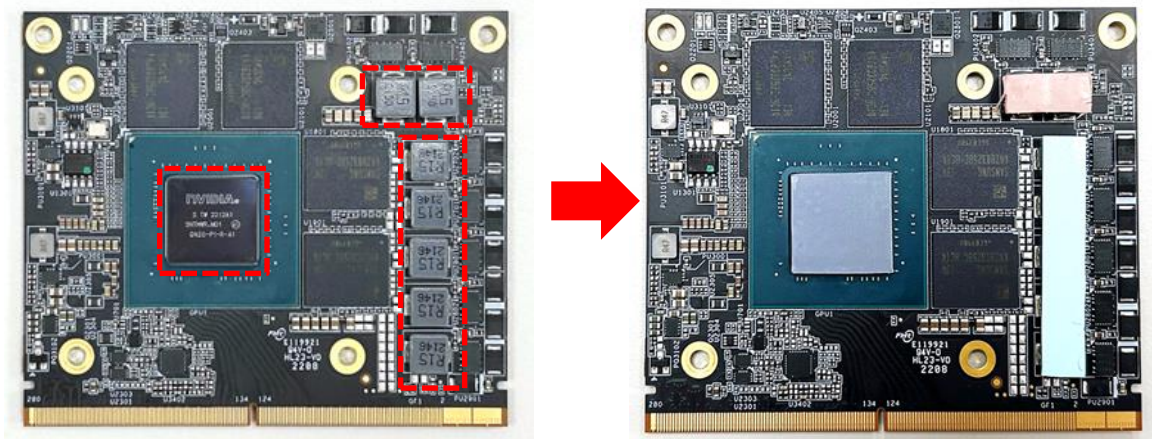



3. Insert the MXM Module into the slot on the MXM carrier board at 45 degrees.

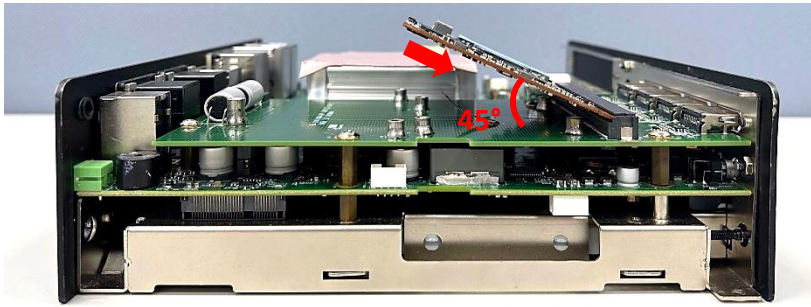

4. Fasten the two screws (M3X5L).

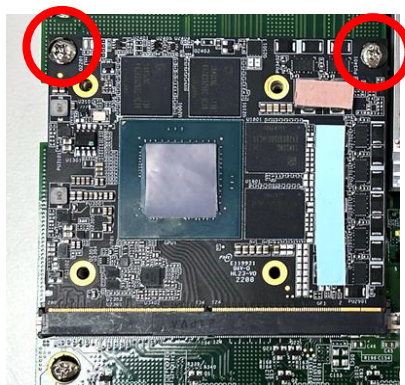

**NOTE  
(NOTE)**

**Before putting on the thermal block (in the next step), please make sure the protective films on the Thermal Pads have been removed!**

**(Avant de mettre le bloc thermique (à l'étape suivante), assurez-vous que les films de protection sur les coussinets thermiques ont été retirés!)**

5. Put on the thermal block with aligning the screw-holes, and fasten the 4 screws (M3X8L).

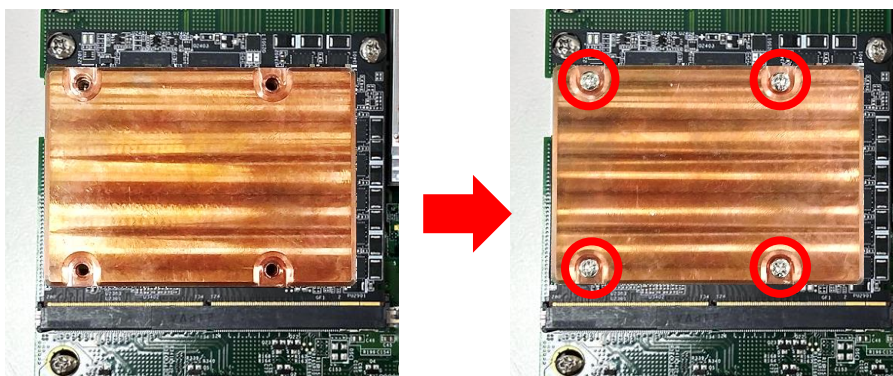

6. Place the thermal pad on the thermal block.



**NOTE  
(NOTE)**

**Before assembling the system's chassis cover, please make sure the protective film on the Thermal Pad has been removed!**  
**(Avant d'assembler le capot du châssis du système, assurez-vous que le film protecteur du coussin thermique a été retiré!)**

***cincoze***

© 2023 Cincoze Co., Ltd. All rights reserved.

The Cincoze logo is a registered trademark of Cincoze Co., Ltd.

All other logos appearing in this catalog are the intellectual property of the respective company, product, or organization associated with the logo.

All product specifications and information are subject to change without notice.